

20²²/₂₃ >

KABLO TAŞIMA SİSTEMLERİ

CABLE MANAGEMENT SYSTEMS

art

POWER CARRYING SOLUTIONS

www.artimmetal.com

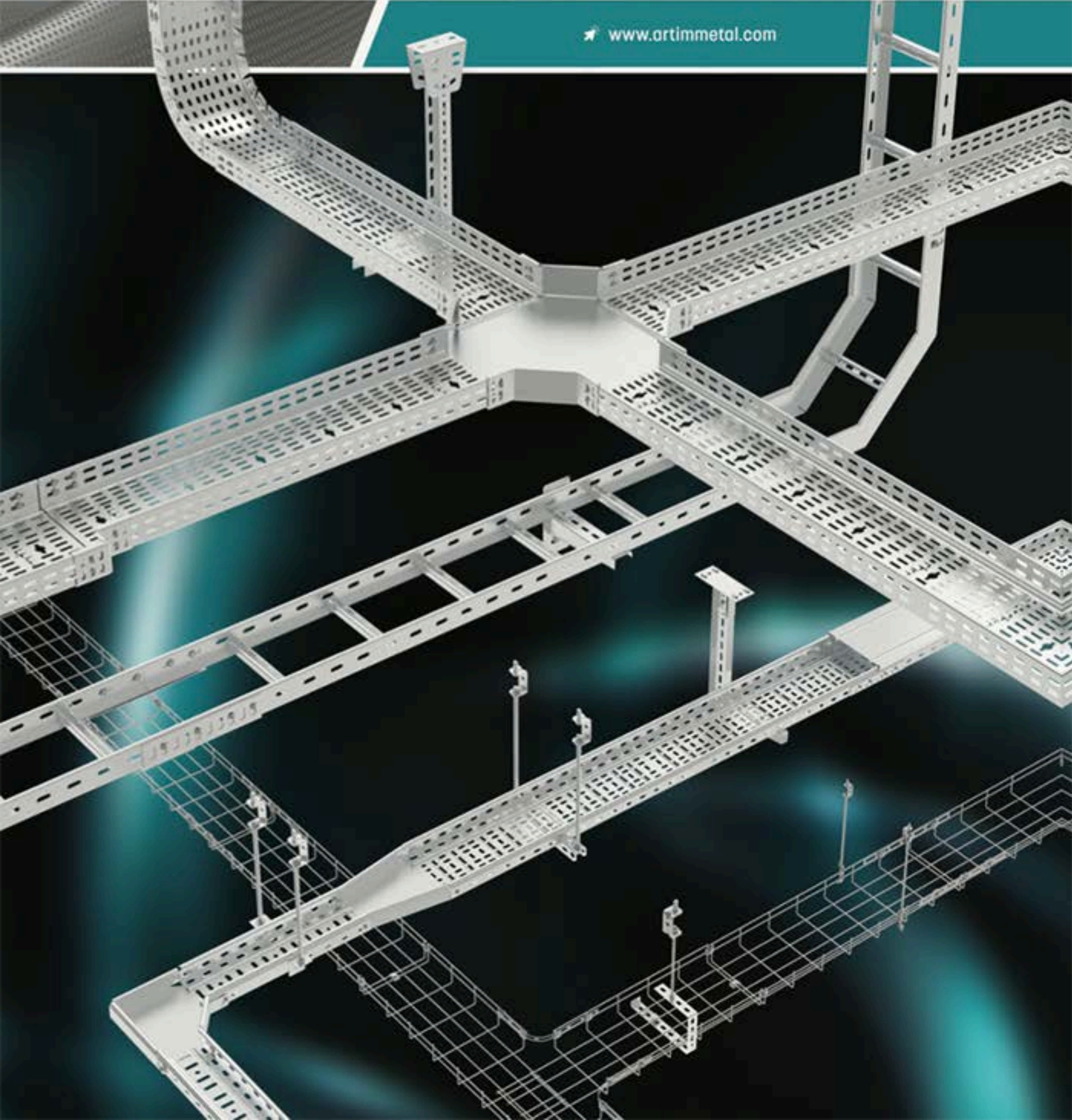

art

POWER CARRYING SOLUTIONS

art

POWER CARRYING SOLUTIONS

ARTIM METAL ELEKTRİK SAN. TİC.A.Ş.

KABLO TAŞIMA SİSTEMLERİ

CABLE MANAGEMENT SYSTEMS



www.artimmetal.com

YANGIN DAYANIM TESTLERİ FIRE RESISTANCE TEST



1.Fotograf
1.Photo



2.Fotograf
2.Photo



3.Fotograf
3.Photo



4.Fotograf
4.Photo

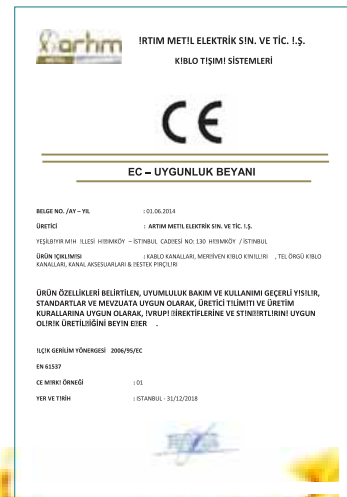



POWER CARRYING SOLUTIONS





ANA FAALİYET ALANLARIMIZ MAIN FIELDS OF ACTIVITY TEST



FABRİKALAR // FACTORIES



SANAYİ TESİSLERİ // INDUSTRIAL PLANTS



OTELLER // HOTELS



OKULLAR // SCHOOLS



HAVAALANLARI // AIRPORTS



HASTANELER // HOSPITALS



TÜNELLER // TUNNELS



ALIŞVERİŞ MERKEZLERİ // SHOPPING MALLS

İÇİNDEKİLER

INDEX

1.BÖLÜM	:	AAU SERİSİ / GOLD FORMLU TİP KABLO KANALI VE AKSESUARLARI	1 - 24
1.PART	:	AAU SERIES / GOLD FORMED TYPE CABLE TRAYS AND ACCESSORIES	
2.BÖLÜM	:	AST-AGH SERİSİ / STANDART TİP - AĞIR HİZMET TİP KABLO KANAL VE AKSESUARLARI	25 - 111
2.PART	:	AST-AGH SERIES / STANDARD TYPE - HEAVY DUTY TYPE CABLE TRAYS AND ACCESSORIES	
3.BÖLÜM	:	TRUNKİNG KABLO KANALLARI VE AKSESUARLARI	112 - 134
3.PART	:	TRUNKING CABLE TRAYS AND ACCESSORIES	
4.BÖLÜM	:	AKM SERİSİ / KABLO MERDİVENİ VE AKSESUARLARI	135 - 165
4.PART	:	AKM SERIES / CABLE LADDER AND ACCESSORIES	
5.BÖLÜM	:	AKK SERİSİ / KABLO KANAL & MERDİVEN KAPAKLARI VE AKSESUARLARI	166 - 186
5.PART	:	AKK SERIES / CABLE TRAY & LADDER COVERS AND ACCESSORIES	
6.BÖLÜM	:	ART SERİSİ / TEL ÖRGÜ KABLO KANAL VE AKSESUARLARI	187 - 200
6.PART	:	ART SERIES / WIREMESH CABLE TRAYS AND ACCESSORIES	
7.BÖLÜM	:	AD SERİSİ / DÖŞEME ALTI KABLO KANALI VE AKSESUARLARI	201 - 207
7.PART	:	AD SERIES / UNDERFLOOR CABLE TRAYS AND ACCESSORIES	
8.BÖLÜM	:	DESTEK SİSTEMLERİ	208 - 256
8.PART	:	SUPPORT SYSTEMS	
9.BÖLÜM	:	TOPRAKLAMA ŞERİDİ VE AKSESUARLARI	257 - 264
9.PART	:	GROUNDING STRAP AND ACCESSORIES	
10.BÖLÜM	:	AG SERİSİ / GEMİ TİPİ KABLO KANAL & MERDİVEN VE AKSESUARLARI	265 - 276
10.PART	:	AG SERIES / SHIP TYPE CABLE TRAYS & STAIRS AND ACCESSORIES	
11.BÖLÜM	:	BORU SİSTEMLERİ	277 - 289
11.PART	:	PIPE SYSTEMS	
12.BÖLÜM	:	HIRDAVAT VE AKSESUARLAR	290 - 299
12.PART	:	HARDWARE AND ACCESSORIES	

KABLO KANALLARI MONTAJ ÖRNEĞİ

CABLE TRAYS MOUNTING EXAMPLE

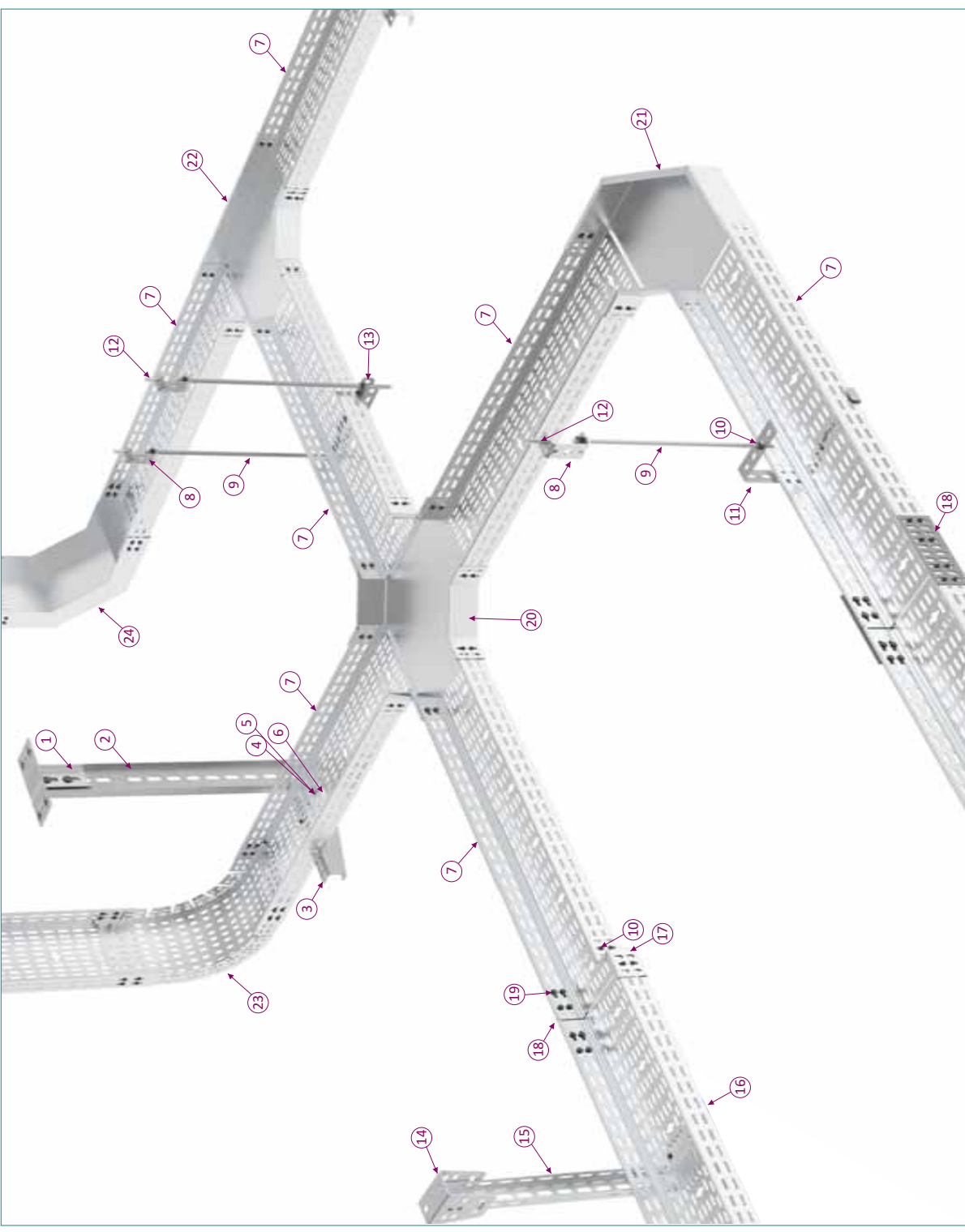

KOD / CODE	KATALOG SAYFA / CATALOG PAGE
1. IDT-1 ... I TAVAN / I CEILING	236
2. ID 80-100 ... I PROFİL / I PROFILE	231
3. IDK 200 ... I KONSOL / I BRACKETS	233
4. AAC-2 ... M10 CIVATA / M10 BOLTS	292
5. ASN-2 ... M10 SOMUN / M10 NUTS	293
6. IDK-EK ... I KONSOL EK / I CONSOLE CONNECTION	233
7. 60 AGH 200 ... KABLO KANALI / CABLE TRAYS	45
8. TT1 ... TİJLİ TAVAN / ROD CEILING	219
9. AT-1 ... TİJ / ROD	294
10. ASN-1 ... SOMUN / NUTS	293
11. YT 200 ... TİJLİ TAŞIYICI / ROD CARRIER	221
12. CSD-2 ... DÜBEL / WALL PEG	295
13. UTK 200 ... TİJLİ TAŞIYICI / ROD CARRIER	219
14. UPG ... U TAVAN / U CEILING	211
15. UP 100 ... U PROFİL / U PROFILE	210
16. US 300 ... U KONSOL / U BRACKETS	214
17. 60 AGH 100R ... REDÜKSİYON / REDUCING	92
18. 60 AST 1 ... EK / CONNECTION	110
19. CV-2 ... M8 CIVATA / M8 BOLTS	292
20. 60 AGH 200D ... DÖRTLÜ / FOUR WAY	66
21. 60 AGH 200Y ... 90° R300 / 90° R300	70
22. 60 AGH 200T ... T / T BEND	62
23. 60 AGH 200B ... HAREKETLİ BÜKEY / ADJUSTABLE BEND	94
24. 60 AST 200B S1 ... SABİT BÜKEY / CONSTANT BEND	98

art

POWER CARRYING SOLUTIONS



GOLD FORMLU TİP KABLO KANALLARI

GOLD FORMED TYPE CABLE TRAYS



H40 AAU SERIES

GOLD FORMLU TİP KABLO KANALI

GOLD FORMED TYPE CABLE TRAYS

PREGALVANİZ (PG)
PREGALVANIZED (PG)
TS EN 10346



Talebe göre; Ek parçalı ve Ek parçasız birleştirme
According to the demand; Joining with and without attachments



Güçlendirilmiş Büküm
Reinforced Bending

0.60 mm

Sipariş Kodu Order Code	W (mm)	T (mm)	Ağırlık (kg/m) Weight (kg/m)	Barkod Kodu Barcode Code
40 AAU 100-06	100	0.60 mm	0,845	2005001
40 AAU 150-06	150	0.60 mm	1,103	2005004
40 AAU 200-06	200	0.60 mm	1,328	2005007

0.70 mm

Sipariş Kodu Order Code	W (mm)	T (mm)	Ağırlık (kg/m) Weight (kg/m)	Barkod Kodu Barcode Code
40 AAU 100-07	100	0.70 mm	0,986	2005002
40 AAU 150-07	150	0.70 mm	1,238	2005005
40 AAU 200-07	200	0.70 mm	1,549	2005008

0.80 mm

Sipariş Kodu Order Code	W (mm)	T (mm)	Ağırlık (kg/m) Weight (kg/m)	Barkod Kodu Barcode Code
40 AAU 100-08	100	0.80 mm	1,127	2005003
40 AAU 150-08	150	0.80 mm	1,472	2005006
40 AAU 200-08	200	0.80 mm	1,771	2005009
40 AAU 300-08	300	0.80 mm	2,400	2005010

1.00 mm

Sipariş Kodu Order Code	W (mm)	T (mm)	Ağırlık (kg/m) Weight (kg/m)	Barkod Kodu Barcode Code
40 AAU 100-10	100	1.00 mm	1,408	2005017
40 AAU 150-10	150	1.00 mm	1,839	2005018
40 AAU 200-10	200	1.00 mm	1,213	2005019
40 AAU 300-10	300	1.00 mm	3,000	2005012
40 AAU 400-10	400	1.00 mm	3,805	2005013

1.20 mm

Sipariş Kodu Order Code	W (mm)	T (mm)	Ağırlık (kg/m) Weight (kg/m)	Barkod Kodu Barcode Code
40 AAU 100-12	100	1.20 mm	1,689	2005020
40 AAU 150-12	150	1.20 mm	2,207	2005021
40 AAU 200-12	200	1.20 mm	2,656	2005022
40 AAU 300-12	300	1.20 mm	3,600	2005023
40 AAU 400-12	400	1.20 mm	4,566	2005014
40 AAU 500-12	500	1.20 mm	5,437	2005016

H = YÜKSEKLİK = HEIGHT / W = GENİŞLİK = WIDTH / T = KALINLIK = THICKNESS

40 AAU 200 - 08

Yükseklik Kanal Tipi Genişlik Kalınlık
Height Type Width Thickness

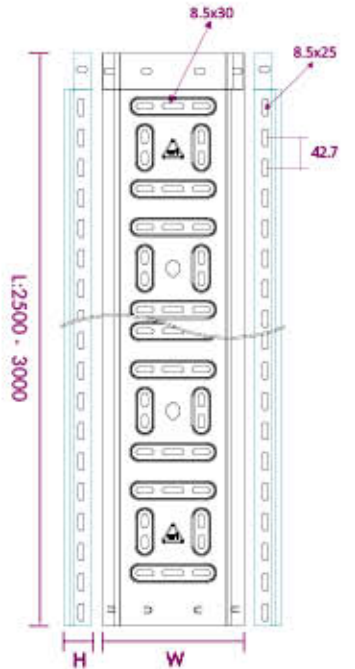
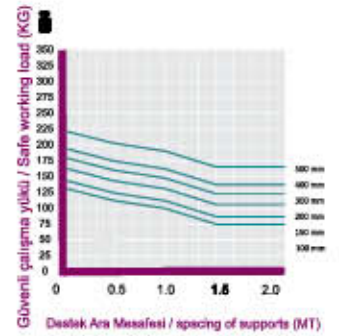

Standart uzunluk L:2500 - 3000 mm
Toplu miktarlarda Özel ölçüler yapılabilir.
Standard Length L:2500 - 3000 mm
Custom sizes can be made in bulk quantities.

ARTIM METAL ELEKTRİK A.Ş.

- Farklı kalınlık ve ölçüde üretim yapılabılır.
- Malzeme ağırlıkları yaklaşık değerlerdir, \pm %10 değişiklik gösterebilir.
- Malzeme kalınlık toleransı \pm %10 dur.
- Lütfen siparişlerinizde sipariş kodu veya ürün kodu ve Kaplama şeklini belirtiniz.

- We can produce cable trays different thickness and dimensions
- Cable trays are shown approximately weight, they could change \pm %10 difference.
- Cable trays thickness tolerances are shown \pm %10 .
- Please Indicate order code and coating type in your orders.

H40 AAU SERIES

GOLD FORMLU TİP KABLO KANALI

GOLD FORMED TYPE CABLE TRAYS

SICAK DALDIRMA (SD)

HOT DIP GALVANIZED (HDG)

TS EN ISO 1461



Talebe göre; Ek parçalı ve Ek parçasız birleştirme
According to the demand; Joining with and without attachments



Güçlendirilmiş Büküm
Reinforced Bending



0.80 mm

Sipariş Kodu Order Code	W (mm)	T (mm)	Ağırlık (kg/m) Weight (kg/m)	Barkod Kodu Barcode Code
40 AAU 100-08	100	0.80 mm	1,240	2005003
40 AAU 150-08	150	0.80 mm	1,619	2005006
40 AAU 200-08	200	0.80 mm	1,948	2005009
40 AAU 300-09	300	0.90 mm	2,640	2005011

1.00 mm

Sipariş Kodu Order Code	W (mm)	T (mm)	Ağırlık (kg/m) Weight (kg/m)	Barkod Kodu Barcode Code
40 AAU 100-10	100	1.00 mm	1,549	2005017
40 AAU 150-10	150	1.00 mm	2,022	2005018
40 AAU 200-10	200	1.00 mm	2,435	2005019
40 AAU 300-10	300	1.00 mm	3,300	2005012
40 AAU 400-10	400	1.00 mm	4,186	2005013

1.20 mm

Sipariş Kodu Order Code	W (mm)	T (mm)	Ağırlık (kg/m) Weight (kg/m)	Barkod Kodu Barcode Code
40 AAU 100-12	100	1.20 mm	1,857	2005020
40 AAU 150-12	150	1.20 mm	2,428	2005021
40 AAU 200-12	200	1.20 mm	2,922	2005022
40 AAU 300-12	300	1.20 mm	3,960	2005023
40 AAU 400-12	400	1.20 mm	5,023	2005014
40 AAU 500-12	500	1.20 mm	5,981	2005016

H = YÜKSEKLİK = HEIGHT / W = GENİŞLİK = WIDTH / T = KALINLIK = THICKNESS

40 AAU 200 - 08

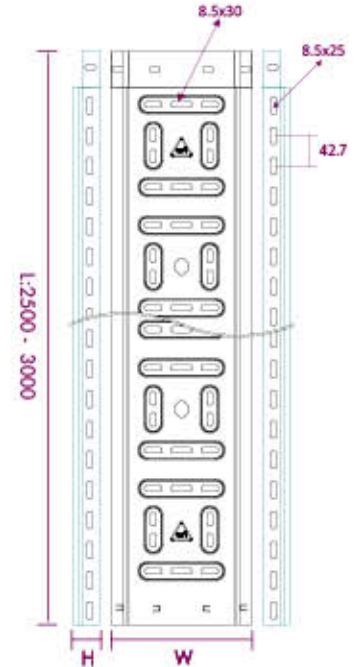
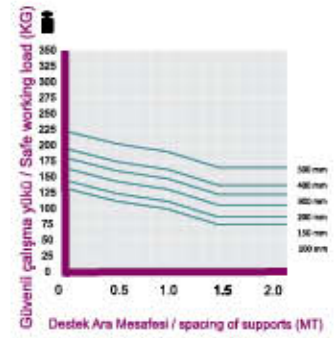

Standart uzunluk L:2500 - 3000 mm
Toplu miktarlarda Özel ölçüler yapılabilir.
Standard Length L:2500 - 3000 mm
Custom sizes can be made in bulk quantities.

- Farklı kalınlık ve ölçülerde üretim yapılabılır.
- Malzeme ağırlıkları yalıdağık değerdendir, ± %10 değışiklik gösterebilir.
- Malzeme kalınlık toleransı ± %10 dur.
- Lütfen siparişinizde sipariş kodu veya ürün kodu ve Kaplama şeklini belirtiniz.

- We can produce cable trays different thickness and dimensions
- Cable trays are shown approximately weight, they could change ± %10 difference.
- Cable trays thickness tolerances are shown ± %10 .
- Please indicate order code and coating type in your orders.

H50 AAU SERIES

GOLD FORMLU TİP KABLO KANALI

GOLD FORMED TYPE CABLE TRAYS

PREGALVANİZ (PG)
PREGALVANIZED (PG)
TS EN 10346



Talebe göre; Ek parçalı ve Ek parçasız birleştirme
According to the demand; Joining with and without attachments



Güçlendirilmiş Büküm
Reinforced Bending

0.60 mm

Sipariş Kodu Order Code	W (mm)	T (mm)	Ağırlık (kg/m) Weight (kg/m)	Barkod Kodu Barcode Code
50 AAU 100-06	100	0.60 mm	0,938	2005051
50 AAU 150-06	150	0.60 mm	1,196	2005054
50 AAU 200-06	200	0.60 mm	1,402	2005057

0.70 mm

Sipariş Kodu Order Code	W (mm)	T (mm)	Ağırlık (kg/m) Weight (kg/m)	Barkod Kodu Barcode Code
50 AAU 100-07	100	0.70 mm	1,093	2005052
50 AAU 150-07	150	0.70 mm	1,395	2005055
50 AAU 200-07	200	0.70 mm	1,656	2005058

0.80 mm

Sipariş Kodu Order Code	W (mm)	T (mm)	Ağırlık (kg/m) Weight (kg/m)	Barkod Kodu Barcode Code
50 AAU 100-08	100	0.80 mm	1,250	2005053
50 AAU 150-08	150	0.80 mm	1,594	2005056
50 AAU 200-08	200	0.80 mm	1,893	2005059
50 AAU 300-08	300	0.80 mm	2,523	2005060

1.00 mm

Sipariş Kodu Order Code	W (mm)	T (mm)	Ağırlık (kg/m) Weight (kg/m)	Barkod Kodu Barcode Code
50 AAU 100-10	100	1.00 mm	1,562	2005067
50 AAU 150-10	150	1.00 mm	1,993	2005068
50 AAU 200-10	200	1.00 mm	2,366	2005069
50 AAU 300-10	300	1.00 mm	3,153	2005062
50 AAU 400-10	400	1.00 mm	3,958	2005063

1.20 mm

Sipariş Kodu Order Code	W (mm)	T (mm)	Ağırlık (kg/m) Weight (kg/m)	Barkod Kodu Barcode Code
50 AAU 100-12	100	1.20 mm	1,875	2005070
50 AAU 150-12	150	1.20 mm	2,392	2005071
50 AAU 200-12	200	1.20 mm	2,838	2005072
50 AAU 300-12	300	1.20 mm	3,784	2005073
50 AAU 400-12	400	1.20 mm	4,750	2005064
50 AAU 500-12	500	1.20 mm	5,812	2005066

H = YÜKSEKLİK = HEIGHT / W = GENİŞLİK = WIDTH / T = KALINLIK = THICKNESS

50 AAU 200 - 08

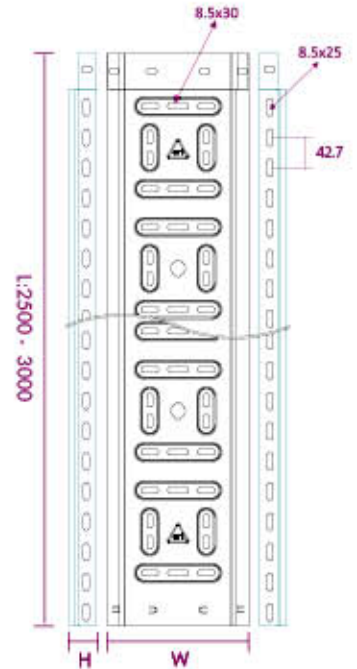
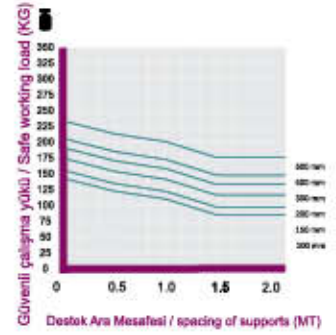
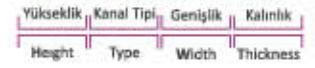

Standart uzunluk L:2500 - 3000 mm
Toplu miktarlarda Özel ölçüler yapılabilir.
Standard Length L:2500 - 3000 mm
Custom sizes can be made in bulk quantities.

ARTIM METAL ELEKTRİK A.Ş.

- Farklı kalınlık ve ölçüde üretim yapılabılır.
- Malzeme ağırlıkları yaklaşık değerlerdir, \pm %10 değişiklik gösterebilir.
- Malzeme kalınlık toleransı \pm %10 dur.
- Lütfen siparişlerinizde sipariş kodu veya ürün kodu ve Kaplama şeklini belirtiniz.

- We can produce cable trays different thickness and dimensions
- Cable trays are shown approximately weight, they could change \pm %10 difference.
- Cable trays thickness tolerances are shown \pm %10 .
- Please indicate order code and coating type in your orders.

H50 AAU SERIES

GOLD FORMLU TİP KABLO KANALI

GOLD FORMED TYPE CABLE TRAYS

SICAK DALDIRMA (SD)
HOT DIP GALVANIZED (HDG)
TS EN ISO 1461



Talebe göre; Ek parçalı ve Ek parçasız birleştirme
According to the demand; Joining with and without attachments



Güçlendirilmiş Büküm
Reinforced Bending



0.80 mm

Sipariş Kodu Order Code	W (mm)	T (mm)	Ağırlık (kg/m) Weight (kg/m)	Barkod Kodu Barcode Code
50 AAU 100-08	100	0.80 mm	1,375	2005053
50 AAU 150-08	150	0.80 mm	1,754	2005056
50 AAU 200-08	200	0.80 mm	2,083	2005059
50 AAU 300-09	300	0.90 mm	2,775	2005061

1.00 mm

Sipariş Kodu Order Code	W (mm)	T (mm)	Ağırlık (kg/m) Weight (kg/m)	Barkod Kodu Barcode Code
50 AAU 100-10	100	1.00 mm	1,718	2005067
50 AAU 150-10	150	1.00 mm	2,192	2005068
50 AAU 200-10	200	1.00 mm	2,603	2005069
50 AAU 300-10	300	1.00 mm	3,464	2005062
50 AAU 400-10	400	1.00 mm	4,354	2005063

1.20 mm

Sipariş Kodu Order Code	W (mm)	T (mm)	Ağırlık (kg/m) Weight (kg/m)	Barkod Kodu Barcode Code
50 AAU 100-12	100	1.20 mm	2,063	2005070
50 AAU 150-12	150	1.20 mm	2,631	2005071
50 AAU 200-12	200	1.20 mm	3,123	2005072
50 AAU 300-12	300	1.20 mm	4,162	2005073
50 AAU 400-12	400	1.20 mm	5,225	2005064
50 AAU 500-12	500	1.20 mm	6,393	2005066

H = YÜKSEKLİK = HEIGHT / W = GENİŞLİK = WIDTH / T = KALINLIK = THICKNESS

50 AAU 200-08

Yükseklik Kanal Tipi Genişlik Kalınlık
Height Type Width Thickness

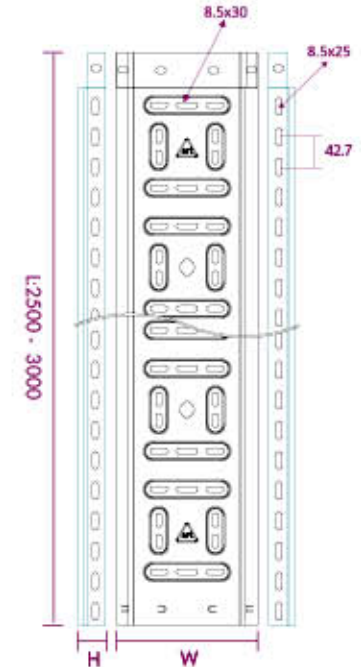
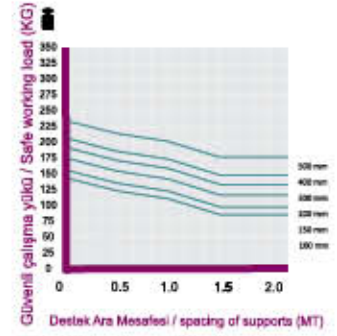

Standart uzunluk L:2500 - 3000 mm
Toplu miktarlarda Özel ölçüler yapılabilir.
Standard Length L:2500 - 3000 mm
Custom sizes can be made in bulk quantities.

- Farklı kalınlık ve ölçülerde üretim yapılabılır.
- Malzeme ağırlıkları yalıdağık değeri, ± %10 değışiklik gösterebilir.
- Malzeme kalınlık toleransı ± %10 dur.
- Lütfen siparişinizde sipariş kodu veya ürün kodu ve kaplama şeklini belirtiniz.

- We can produce cable trays different thickness and dimensions
- Cable trays are shown approximately weight, they could change ± %10 difference.
- Cable trays thickness tolerances are shown ± %10 .
- Please indicate order code and coating type in your orders.

H60 AAU SERIES

GOLD FORMLU TİP KABLO KANALI

GOLD FORMED TYPE CABLE TRAYS

PREGALVANİZ (PG)
PREGALVANIZED (PG)
TS EN 10346



Talebe göre; Ek parçalı ve Ek parçasız birleştirme
According to the demand; Joining with and without attachments



Güçlendirilmiş Büküm
Reinforced Bending

0.60 mm

Sipariş Kodu Order Code	W (mm)	T (mm)	Ağırlık (kg/m) Weight (kg/m)	Barkod Kodu Barcode Code
60 AAU 100-06	100	0.60 mm	1,033	2005101
60 AAU 150-06	150	0.60 mm	1,290	2005104
60 AAU 200-06	200	0.60 mm	1,516	2005107

0.70 mm

Sipariş Kodu Order Code	W (mm)	T (mm)	Ağırlık (kg/m) Weight (kg/m)	Barkod Kodu Barcode Code
60 AAU 100-07	100	0.70 mm	1,204	2005102
60 AAU 150-07	150	0.70 mm	1,504	2005105
60 AAU 200-07	200	0.70 mm	1,768	2005108

0.80 mm

Sipariş Kodu Order Code	W (mm)	T (mm)	Ağırlık (kg/m) Weight (kg/m)	Barkod Kodu Barcode Code
60 AAU 100-08	100	0.80 mm	1,377	2005103
60 AAU 150-08	150	0.80 mm	1,719	2005106
60 AAU 200-08	200	0.80 mm	2,020	2005109
60 AAU 300-08	300	0.80 mm	2,650	2005110

1.00 mm

Sipariş Kodu Order Code	W (mm)	T (mm)	Ağırlık (kg/m) Weight (kg/m)	Barkod Kodu Barcode Code
60 AAU 100-10	100	1.00 mm	1,721	2005117
60 AAU 150-10	150	1.00 mm	2,149	2005118
60 AAU 200-10	200	1.00 mm	2,525	2005119
60 AAU 300-10	300	1.00 mm	3,312	2005112
60 AAU 400-10	400	1.00 mm	4,116	2005113

1.20 mm

Sipariş Kodu Order Code	W (mm)	T (mm)	Ağırlık (kg/m) Weight (kg/m)	Barkod Kodu Barcode Code
60 AAU 100-12	100	1.20 mm	2,065	2005120
60 AAU 150-12	150	1.20 mm	2,579	2005121
60 AAU 200-12	200	1.20 mm	3,030	2005122
60 AAU 300-12	300	1.20 mm	3,975	2005123
60 AAU 400-12	400	1.20 mm	4,940	2005114
60 AAU 500-12	500	1.20 mm	5,622	2005116

H = YÜKSEKLİK = HEIGHT / W = GENİŞLİK = WIDTH / T = KALINLIK = THICKNESS

60 AAU 200 - 08

Yükseklik Kanal Tipi Genişlik Kalınlık
Height Type Width Thickness

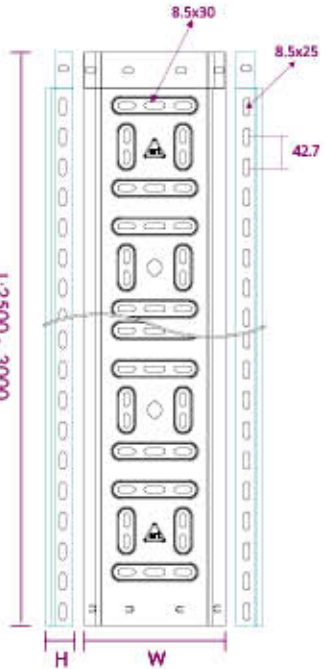
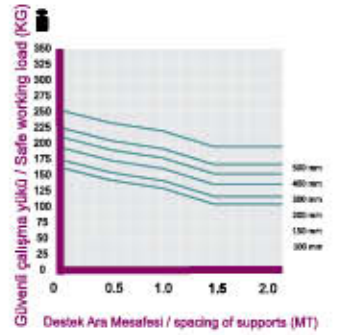

Standart uzunluk L:2500 - 3000 mm
Toplu miktarlarda Özel ölçüler yapılabilir.
Standard Length L:2500 - 3000 mm
Custom sizes can be made in bulk quantities.

ARTIM METAL ELEKTRİK A.Ş.

- Farklı kalınlık ve ölçüde üretim yapılabılır.
- Malzeme ağırlıkları yaklaşık değerlerdir, ± %10 değişiklik gösterebilir.
- Malzeme kalınlık toleransı ± %10 dur.
- Lütfen siparişlerinizde sipariş kodu veya ürün kodu ve Kaplama şeklini belirtiniz.

- We can produce cable trays different thickness and dimensions
- Cable trays are shown approximately weight, they could change ± %10 difference.
- Cable trays thickness tolerances are shown ± %10 .
- Please Indicate order code and coating type in your orders.

H60 AAU SERIES

GOLD FORMLU TİP KABLO KANALI

GOLD FORMED TYPE CABLE TRAYS

SICAK DALDIRMA (SD)
HOT DIP GALVANIZED (HDG)
TS EN ISO 1461



Talebe göre; Ek parçalı ve Ek parçasız birleştirme
According to the demand; Joining with and without attachments



Güçlendirilmiş Büküm
Reinforced Bending



0.80 mm

Sipariş Kodu Order Code	W (mm)	T (mm)	Ağırlık (kg/m) Weight (kg/m)	Barkod Kodu Barcode Code
60 AAU 100-08	100	0.80 mm	1,515	2005103
60 AAU 150-08	150	0.80 mm	1,891	2005106
60 AAU 200-08	200	0.80 mm	2,222	2005109
60 AAU 300-09	300	0.90 mm	2,915	2005111

1.00 mm

Sipariş Kodu Order Code	W (mm)	T (mm)	Ağırlık (kg/m) Weight (kg/m)	Barkod Kodu Barcode Code
60 AAU 100-10	100	1.00 mm	1,893	2005117
60 AAU 150-10	150	1.00 mm	2,364	2005118
60 AAU 200-10	200	1.00 mm	2,778	2005119
60 AAU 300-10	300	1.00 mm	3,643	2005112
60 AAU 400-10	400	1.00 mm	4,528	2005113

1.20 mm

Sipariş Kodu Order Code	W (mm)	T (mm)	Ağırlık (kg/m) Weight (kg/m)	Barkod Kodu Barcode Code
60 AAU 100-12	100	1.20 mm	2,272	2005120
60 AAU 150-12	150	1.20 mm	2,837	2005121
60 AAU 200-12	200	1.20 mm	3,333	2005122
60 AAU 300-12	300	1.20 mm	4,373	2005123
60 AAU 400-12	400	1.20 mm	5,435	2005114
60 AAU 500-12	500	1.20 mm	6,184	2005116

H = YÜKSEKLİK = HEIGHT / W = GENİŞLİK = WIDTH / T = KALINLIK = THICKNESS

60 AAU 200-08

Yükseklik Kanal Tipi Genişlik Kalınlık
Height Type Width Thickness

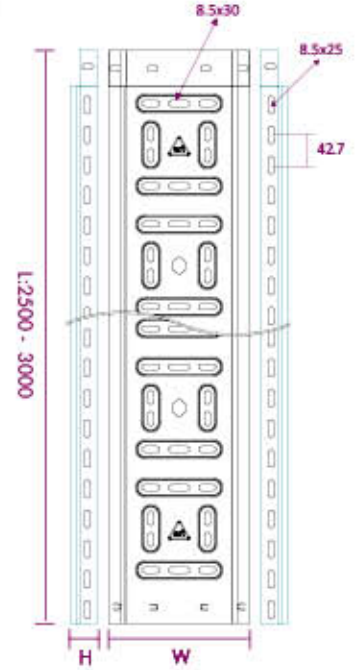
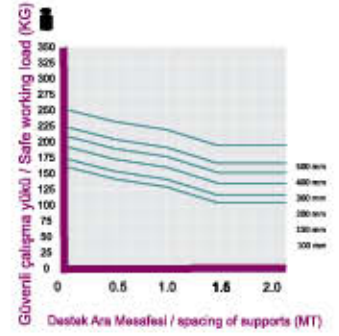

Standart uzunluk L:2500 - 3000 mm
Toplu miktarlarda Özel ölçüler yapılabilir.
Standard Length L:2500 - 3000 mm
Custom sizes can be made in bulk quantities.

- Farklı kalınlık ve ölçülerde üretim yapılabılır.
- Malzeme ağırlıkları yalıdağık değerdır, ± %10 değışıklık gösterebilir.
- Malzeme kalınlık toleransı ± %10 dur.
- Lütfen siparişinizde sipariş kodu veya ürün kodu ve kaplama şeklini belirtiniz.

- We can produce cable trays different thickness and dimensions
- Cable trays are shown approximately weight, they could change ± %10 difference.
- Cable trays thickness tolerances are shown ± %10 .
- Please indicate order code and coating type in your orders.

H100 AAU SERIES

GOLD FORMLU TİP KABLO KANALI

GOLD FORMED TYPE CABLE TRAYS

PREGALVANİZ (PG)
PREGALVANIZED (PG)
TS EN 10346



Talebe göre; Ek parçalı ve Ek parçasız birleştirme
According to the demand; Joining with and without attachments



Güçlendirilmiş Büküm
Reinforced Bending

Sipariş Kodu Order Code	W (mm)	T (mm)	Ağırlık (kg/m) Weight (kg/m)	Barkod Kodu Barcode Code
100 AAU 100-08	100	0.80 mm	1,776	2005151
100 AAU 150-08	150	0.80 mm	2,108	2005160
100 AAU 200-08	200	0.80 mm	2,384	2005161

Sipariş Kodu Order Code	W (mm)	T (mm)	Ağırlık (kg/m) Weight (kg/m)	Barkod Kodu Barcode Code
100 AAU 100-09	100	0.90 mm	1,997	2005152
100 AAU 150-09	150	0.90 mm	2,373	2005153
100 AAU 200-09	200	0.90 mm	2,682	2005155

Sipariş Kodu Order Code	W (mm)	T (mm)	Ağırlık (kg/m) Weight (kg/m)	Barkod Kodu Barcode Code
100 AAU 100-10	100	1.00 mm	2,219	2005162
100 AAU 150-10	150	1.00 mm	2,636	2005154
100 AAU 200-10	200	1.00 mm	2,980	2005156
100 AAU 300-10	300	1.00 mm	3,741	2005157
100 AAU 400-10	400	1.00 mm	4,536	2005163

Sipariş Kodu Order Code	W (mm)	T (mm)	Ağırlık (kg/m) Weight (kg/m)	Barkod Kodu Barcode Code
100 AAU 100-12	100	1.20 mm	2,663	2005164
100 AAU 150-12	150	1.20 mm	3,164	2005165
100 AAU 200-12	200	1.20 mm	3,576	2005166
100 AAU 300-12	300	1.20 mm	4,490	2005158
100 AAU 400-12	400	1.20 mm	5,444	2005159

H = YÜKSEKLİK = HEIGHT / W = GENİŞLİK = WIDTH / T = KALINLIK = THICKNESS



ARTIM METAL ELEKTRİK A.Ş.

100 AAU 200-10

Yükseklik Kanal Tipi Genişlik Kalınlık
Height Type Width Thickness

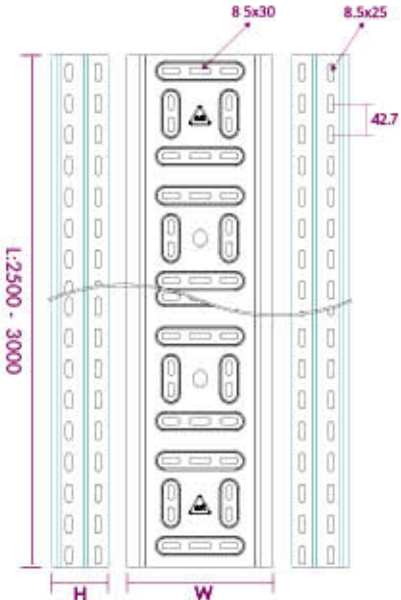
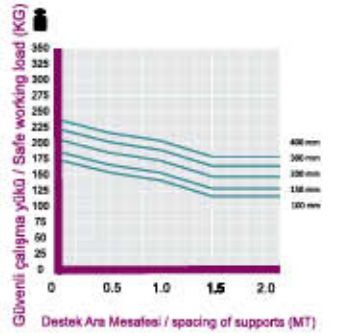

Standart uzunluk L:2500 - 3000 mm
Toplu miktarlarda Özel ölçüler yapılabilir.
Standard Length L:2500 - 3000 mm
Custom sizes can be made in bulk quantities.

- Farklı kalınlık ve ölçüde üretim yapılabilir.
- Malzeme ağırlıkları yaklaşık değerlerdir, \pm %10 değişiklik gösterebilir.
- Malzeme kalınlık toleransı \pm %10 dur.
- Lütfen siparişlerinizde sipariş kodu veya ürün kodu ve Kaplama şeklini belirtiniz.

- We can produce cable trays different thickness and dimensions
- Cable trays are shown approximately weight, they could change \pm %10 difference.
- Cable trays thickness tolerances are shown \pm %10.
- Please indicate order code and coating type in your orders.

H100 AAU SERIES

GOLD FORMLU TİP KABLO KANALI

GOLD FORMED TYPE CABLE TRAYS

SICAK DALDIRMA (SD)
HOT DIP GALVANIZED (HDG)
TS EN ISO 1461



Talebe göre; Ek parçalı ve Ek parçasız birleştirme
According to the demand; Joining with and without attachments

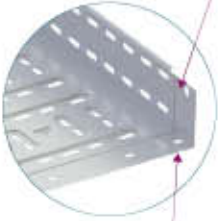

Güçlendirilmiş Büküm
Reinforced Bending

0.80 mm

Sipariş Kodu Order Code	W (mm)	T (mm)	Ağırlık (kg/m) Weight (kg/m)	Barkod Kodu Barcode Code
100 AAU 100-09	100	0.90 mm	2,197	2005152
100 AAU 150-09	150	0.90 mm	2,611	2005153
100 AAU 200-09	200	0.90 mm	2,951	2005155

1.00 mm

Sipariş Kodu Order Code	W (mm)	T (mm)	Ağırlık (kg/m) Weight (kg/m)	Barkod Kodu Barcode Code
100 AAU 100-10	100	1.00 mm	2,441	2005162
100 AAU 150-10	150	1.00 mm	2,897	2005154
100 AAU 200-10	200	1.00 mm	3,278	2005156
100 AAU 300-10	300	1.00 mm	4,115	2005157
100 AAU 400-10	400	1.00 mm	4,990	2005163

1.20 mm

Sipariş Kodu Order Code	W (mm)	T (mm)	Ağırlık (kg/m) Weight (kg/m)	Barkod Kodu Barcode Code
100 AAU 100-12	100	1.20 mm	2,929	2005164
100 AAU 150-12	150	1.20 mm	3,481	2005165
100 AAU 200-12	200	1.20 mm	3,934	2005166
100 AAU 300-12	300	1.20 mm	4,939	2005158
100 AAU 400-12	400	1.20 mm	5,988	2005159

H = YÜKSEKLİK = HEIGHT / W = GENİŞLİK = WIDTH / T = KALINLIK = THICKNESS

100 AAU 200 - 10

Yükseklik Kanal Tipi Genişlik Kalınlık
Height Type Width Thickness

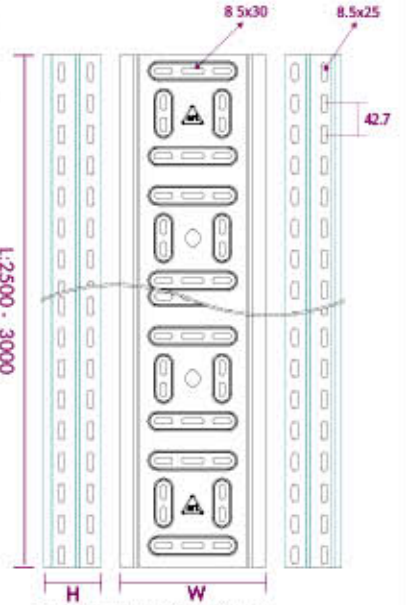
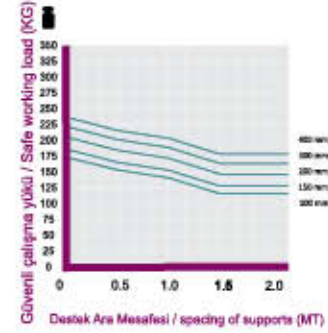

Standart uzunluk L:2500 - 3000 mm
Toplu miktarlarda Özel ölçüler yapılabilir.
Standard Length L:2500 - 3000 mm
Custom sizes can be made in bulk quantities.

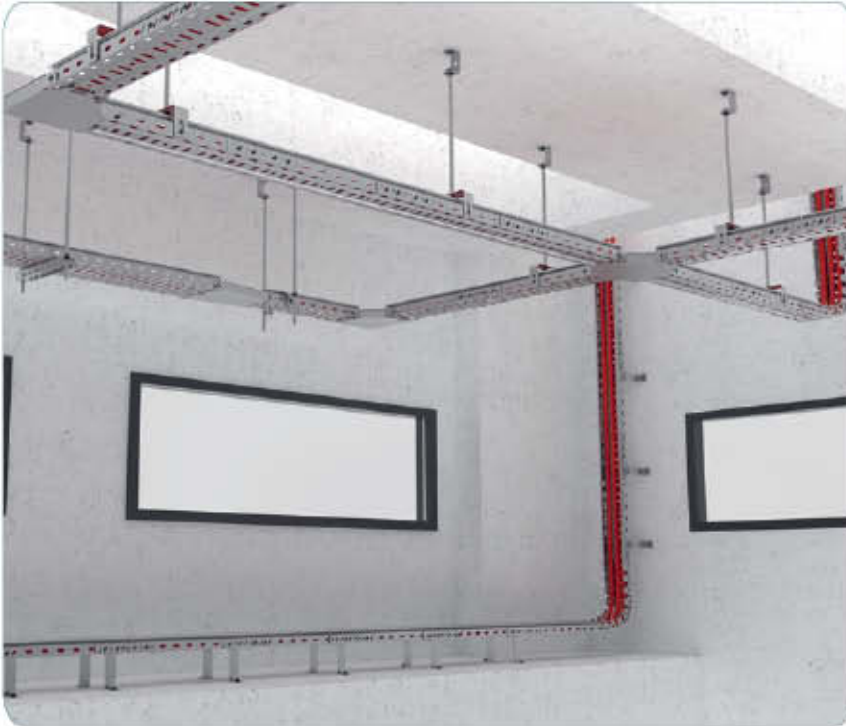

- Farklı kalınlık ve ölçülerde üretim yapılabılır.
- Malzeme ağırlıkları yalıdağık değeerlerdir, ± %10 değęiklik gősterebilir.
- Malzeme kalınlık toleransı ± %10 dur.
- Lütfen siparişinizde sipariş kodu veya ürün kodu ve kaplama şeklini belirtiniz.

- We can produce cable trays different thickness and dimensions
- Cable trays are shown approximately weight, they could change ± %10 difference.
- Cable trays thickness tolerances are shown ± %10 .
- Please indicate order code and coating type in your orders.

AAU SERIES

90° YATAY DÖNÜS (GOLD FORMLU TIP)

90° BEND (GOLD FORMED TYPE)

PREGALVANIZ (PG)
PREGALVANIZED (PG)
TS EN 10346



H40 = H50 = H60 Tek delikli
H40 = H50 = H60 One hole



ARTIM METAL ELEKTRİK A.Ş.

- * Farklı kalınlık ve ölçülerde üretim yapıla bilinir
- * Malzeme ayrırlıkları yaklaşık değerlerdir ± %10 deöipiklik gösterebilir.
- * Malzeme kalınlık toleransı ± %10 dur
- * Lütfen siparişlerinizde sipariş kodu veya ürün kodu ve kaplama beklini belirtiniz.

H40

Sipariş Kodu Order Code	W (mm)	T (mm)	Ağırlık (kg/ad) Weight (kg/pcs)	Barkod Kodu Barcode Code
40 AAU 100Y	100	1.00 mm	0,490	2005300
40 AAU 150Y	150	1.00 mm	0,710	2005301
40 AAU 200Y	200	1.00 mm	0,970	2005302
40 AAU 300Y	300	1.00 mm	1,600	2005303
40 AAU 400Y	400	1.00 mm	2,390	2005304
40 AAU 500Y	500	1.00 mm	3,180	2005305

H50

Sipariş Kodu Order Code	W (mm)	T (mm)	Ağırlık (kg/ad) Weight (kg/pcs)	Barkod Kodu Barcode Code
50 AAU 100Y	100	1.00 mm	0,530	2005350
50 AAU 150Y	150	1.00 mm	0,750	2005351
50 AAU 200Y	200	1.00 mm	1,020	2005352
50 AAU 300Y	300	1.00 mm	1,670	2005353
50 AAU 400Y	400	1.00 mm	2,470	2005354
50 AAU 500Y	500	1.00 mm	3,270	2005355

H60

Sipariş Kodu Order Code	W (mm)	T (mm)	Ağırlık (kg/ad) Weight (kg/pcs)	Barkod Kodu Barcode Code
60 AAU 100Y	100	1.00 mm	0,560	2005400
60 AAU 150Y	150	1.00 mm	0,800	2005401
60 AAU 200Y	200	1.00 mm	1,070	2005402
60 AAU 300Y	300	1.00 mm	1,730	2005403
60 AAU 400Y	400	1.00 mm	2,550	2005404
60 AAU 500Y	500	1.00 mm	3,370	2005405

H100

Sipariş Kodu Order Code	W (mm)	T (mm)	Ağırlık (kg/ad) Weight (kg/pcs)	Barkod Kodu Barcode Code
100 AAU 100Y	100	1.00 mm	0,700	2005450
100 AAU 150Y	150	1.00 mm	0,960	2005451
100 AAU 200Y	200	1.00 mm	1,270	2005452
100 AAU 300Y	300	1.00 mm	1,990	2005453
100 AAU 400Y	400	1.00 mm	2,870	2005454

H = YÜKSEKLİK = HEIGHT / W = GENİŞLİK = WIDTH / T = KALINLIK = THICKNESS

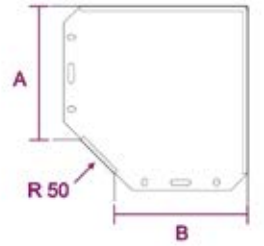
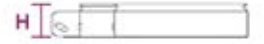
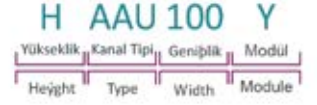

Dönüşlerde "A-B" ölçüleri esit olarak üretilmektedir. İsteğe bağlı olarak farklı ölçülerde üretim yapılır. Bends are produced same dimension for "A-B" as well as we can produce special dimensions regarding your inquiry.

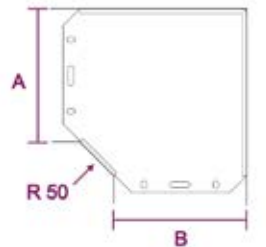

- We can produce cable trays different thickness and dimensions
- Cable trays are shown approximately weight, they could change ± %10 difference.
- Cable trays thickness tolerances are shown ± %10 .
- Please indicate order code and coating type in your orders.

AAU SERIES

90° YATAY DÖNÜS (GOLD FORMLU TIP)

90° BEND (GOLD FORMED TYPE)

SICAK DALDIRMA (SD)

HOT DIP GALVANIZED (SD)

TS EN ISO 1461



H40 = H50 = H60 Tek delikli
H40 = H50 = H60 One hole



H40

Sipariş Kodu Order Code	W (mm)	T (mm)	Ağırlık (kg/ad) Weight (kg/pcs)	Barkod Kodu Barcode Code
40 AAU 100Y	100	1.20 mm	0,635	2005300
40 AAU 150Y	150	1.20 mm	0,920	2005301
40 AAU 200Y	200	1.20 mm	1,257	2005302
40 AAU 300Y	300	1.20 mm	2,074	2005303
40 AAU 400Y	400	1.20 mm	3,097	2005304
40 AAU 500Y	500	1.20 mm	4,120	2005305

H50

Sipariş Kodu Order Code	W (mm)	T (mm)	Ağırlık (kg/ad) Weight (kg/pcs)	Barkod Kodu Barcode Code
50 AAU 100Y	100	1.20 mm	0,687	2005350
50 AAU 150Y	150	1.20 mm	0,972	2005351
50 AAU 200Y	200	1.20 mm	1,322	2005352
50 AAU 300Y	300	1.20 mm	2,164	2005353
50 AAU 400Y	400	1.20 mm	3,201	2005354
50 AAU 500Y	500	1.20 mm	4,238	2005355

H60

Sipariş Kodu Order Code	W (mm)	T (mm)	Ağırlık (kg/ad) Weight (kg/pcs)	Barkod Kodu Barcode Code
60 AAU 100Y	100	1.20 mm	0,726	2005400
60 AAU 150Y	150	1.20 mm	1,037	2005401
60 AAU 200Y	200	1.20 mm	1,387	2005402
60 AAU 300Y	300	1.20 mm	2,242	2005403
60 AAU 400Y	400	1.20 mm	3,305	2005404
60 AAU 500Y	500	1.20 mm	4,368	2005405

H100

Sipariş Kodu Order Code	W (mm)	T (mm)	Ağırlık (kg/ad) Weight (kg/pcs)	Barkod Kodu Barcode Code
100 AAU 100Y	100	1.20 mm	0,907	2005450
100 AAU 150Y	150	1.20 mm	1,244	2005451
100 AAU 200Y	200	1.20 mm	1,646	2005452
100 AAU 300Y	300	1.20 mm	2,579	2005453
100 AAU 400Y	400	1.20 mm	3,720	2005454

H = YÜKSEKLİK = HEIGHT / W = GENİŞLİK = WIDTH / T = KALINLIK = THICKNESS

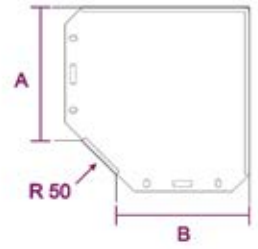

Dönüşlerde "A-B" ölçüleri eşit olarak üretilmektedir. İsteğe bağlı olarak farklı ölçülerde üretim yapılır. Bends are produced same dimension for "A-B" as well as we can produce special dimensions regarding your inquiry.

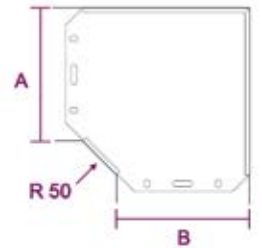

* Farklı kalınlık ve ölçülerde üretim yapıla bilinir
* Malzeme adıyla yaklaşıklık değerlerdir ± %10 değişiklik gösterebilir.
* Malzeme kalınlık toleransı ± %10 dur
* Lütfen siparişlerinizde sipariş kodu veya ürün kodu ve kaplama beklini belirtiniz.

* We can produce cable trays different thickness and dimensions
* Cable trays are shown approximately weight, they could change ± %10 difference.
* Cable trays thickness tolerances are shown ± %10 .
* Please indicate order code and coating type in your orders.

AAU SERIES

T BAGLANTI (GOLD FORMLU TIP)

T BEND (GOLD FORMED TYPE)

PREGALVANİZ (PG)
PREGALVANIZED (PG)
TS EN 10346



H40 = H50 = H60 Tek delikli
H40 = H50 = H60 One hole



H40

Sipariş Kodu Order Code	W (mm)	T (mm)	Ağırlık (kg/ad) Weight (kg/pcs)	Barkod Kodu Barcode Code
40 AAU 100T	100	1.00 mm	0,500	2005600
40 AAU 150T	150	1.00 mm	0,720	2005601
40 AAU 200T	200	1.00 mm	0,980	2005602
40 AAU 300T	300	1.00 mm	1,620	2005603
40 AAU 400T	400	1.00 mm	2,420	2005604
40 AAU 500T	500	1.00 mm	3,220	2005605

H50

Sipariş Kodu Order Code	W (mm)	T (mm)	Ağırlık (kg/ad) Weight (kg/pcs)	Barkod Kodu Barcode Code
50 AAU 100T	100	1.00 mm	0,560	2005650
50 AAU 150T	150	1.00 mm	0,790	2005651
50 AAU 200T	200	1.00 mm	1,060	2005652
50 AAU 300T	300	1.00 mm	1,720	2005653
50 AAU 400T	400	1.00 mm	2,540	2005653
50 AAU 500T	500	1.00 mm	3,360	2005654

H60

Sipariş Kodu Order Code	W (mm)	T (mm)	Ağırlık (kg/ad) Weight (kg/pcs)	Barkod Kodu Barcode Code
60 AAU 100T	100	1.00 mm	0,620	2005700
60 AAU 150T	150	1.00 mm	0,870	2005701
60 AAU 200T	200	1.00 mm	1,150	2005702
60 AAU 300T	300	1.00 mm	1,820	2005703
60 AAU 400T	400	1.00 mm	2,660	2005704
60 AAU 500T	500	1.00 mm	3,500	2005705

H100

Sipariş Kodu Order Code	W (mm)	T (mm)	Ağırlık (kg/ad) Weight (kg/pcs)	Barkod Kodu Barcode Code
100 AAU 100T	100	1.00 mm	0,870	2005750
100 AAU 150T	150	1.00 mm	1,150	2005751
100 AAU 200T	200	1.00 mm	1,470	2005752
100 AAU 300T	300	1.00 mm	2,230	2005753
100 AAU 400T	400	1.00 mm	3,140	2005754

H = YÜKSEKLİK = HEIGHT / W = GENİŞLİK = WIDTH / T = KALINLIK = THICKNESS

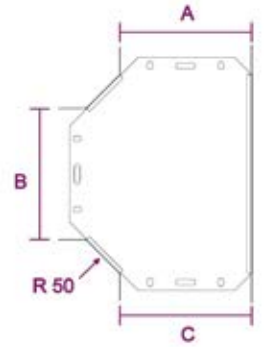
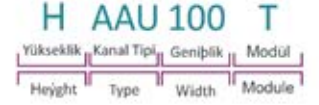

Dönüşlerde "A-B-C" ölçüleri eşit olarak üretilemektedir. İsteğe bağlı olarak farklı ölçülerde üretim yapılır. Bends are produced same dimension for "A-B-C" as well as we can produce special dimensions regarding your inquiry.

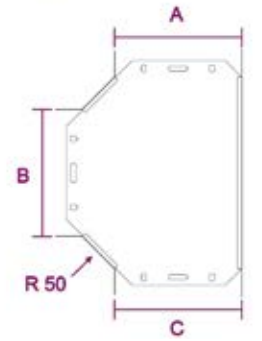
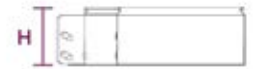

ARTIM METAL ELEKTRİK A.Ş.

* Farklı kalınlık ve ölçülerde üretim yapıla bilinir
* Malzeme ayrırlıkları yaklaşık değerlerdir ± %10 deñiþliklik gösterebilir.
* Malzeme kalınlık toleransları ± %10 dur
* Lütfen siparişlerinizde sipariş kodu veya ürün kodu ve kaplama beklini belirtiniz.

* We can produce cable trays different thickness and dimensions
* Cable trays are shown approximately weight, they could change ± %10 difference.
* Cable trays thickness tolerances are shown ± %10 .
* Please indicate order code and coating type in your orders.

AAU SERIES

T BAGLANTI (GOLD FORMLU TIP)

T BEND (GOLD FORMED TYPE)

SICAK DALDIRMA (SD)
HOT DIP GALVANIZED (SD)
TS EN ISO 1461



H40 = H50 = H60 Tek delikli
H40 = H50 = H60 One hole



H40

Sipariş Kodu Order Code	W (mm)	T (mm)	Ağırlık (kg/ad) Weight (kg/pcs)	Barkod Kodu Barcode Code
40 AAU 100T	100	1.20 mm	0,648	2005600
40 AAU 150T	150	1.20 mm	0,933	2005601
40 AAU 200T	200	1.20 mm	1,270	2005602
40 AAU 300T	300	1.20 mm	2,099	2005603
40 AAU 400T	400	1.20 mm	3,136	2005604
40 AAU 500T	500	1.20 mm	4,536	2005605

H50

Sipariş Kodu Order Code	W (mm)	T (mm)	Ağırlık (kg/ad) Weight (kg/pcs)	Barkod Kodu Barcode Code
50 AAU 100T	100	1.20 mm	0,726	2005650
50 AAU 150T	150	1.20 mm	1,024	2005651
50 AAU 200T	200	1.20 mm	1,373	2005652
50 AAU 300T	300	1.20 mm	2,229	2005653
50 AAU 400T	400	1.20 mm	3,292	2005653
50 AAU 500T	500	1.20 mm	4,355	2005654

H60

Sipariş Kodu Order Code	W (mm)	T (mm)	Ağırlık (kg/ad) Weight (kg/pcs)	Barkod Kodu Barcode Code
60 AAU 100T	100	1.20 mm	0,804	2005700
60 AAU 150T	150	1.20 mm	1,128	2005701
60 AAU 200T	200	1.20 mm	1,490	2005702
60 AAU 300T	300	1.20 mm	2,359	2005703
60 AAU 400T	400	1.20 mm	3,447	2005704
60 AAU 500T	500	1.20 mm	4,535	2005705

H100

Sipariş Kodu Order Code	W (mm)	T (mm)	Ağırlık (kg/ad) Weight (kg/pcs)	Barkod Kodu Barcode Code
100 AAU 100T	100	1.20 mm	1,128	2005750
100 AAU 150T	150	1.20 mm	1,490	2005751
100 AAU 200T	200	1.20 mm	1,905	2005752
100 AAU 300T	300	1.20 mm	2,890	2005753
100 AAU 400T	400	1.20 mm	4,069	2005754

H = YÜKSEKLİK = HEIGHT / W = GENİŞLİK = WIDTH / T = KALINLIK = THICKNESS

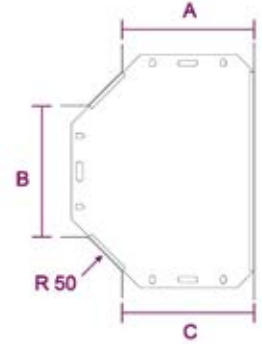
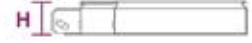
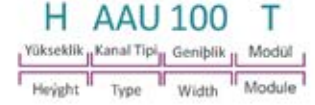

Donüşlerde "A-B-C" ölçüleri esit olarak üretilmektedir. İsteğe bağlı olarak farklı ölçülerde üretim yapılır. Bends are produced same dimension for "A-B-C" as well as we can produce special dimensions regarding your inquiry.

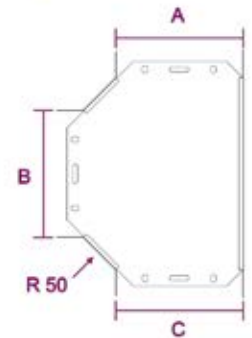
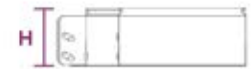

* Farklı kalınlık ve ölçülerde üretim yapıla bilinir
* Malzeme ağırlıklarını yaklaşık değerlerdir ± %10 değişiklik gösterebilir.
* Malzeme kalınlık toleransı ± %10 dur
* Lütfen siparişlerinizde sipariş kodu veya ürün kodu ve kaplama beklini belirtiniz.

* We can produce cable trays different thickness and dimensions
* Cable trays are shown approximately weight, they could change ± %10 difference.
* Cable trays thickness tolerances are shown ± %10 .
* Please indicate order code and coating type in your orders.

AAU SERIES

DÖRTLÜ BAGLANTI (GOLD FORMLU TIP)

FOUR WAY CROSSING (GOLD FORMED TYPE)

PREGALVANIZ (PG)
PREGALVANIZED (PG)
TS EN 10346



H40 = H50 = H60 Tek delikli
H40 = H50 = H60 One hole



H40

Sipariş Kodu Order Code	W (mm)	T (mm)	Ağırlık (kg/ad) Weight (kg/pcs)	Barkod Kodu Barcode Code
40 AAU 100D	100	1.00 mm	0,610	2005900
40 AAU 150D	150	1.00 mm	0,850	2005901
40 AAU 200D	200	1.00 mm	1,130	2005902
40 AAU 300D	300	1.00 mm	1,800	2005903
40 AAU 400D	400	1.00 mm	2,630	2005904
40 AAU 500D	500	1.00 mm	3,460	2005905

H50

Sipariş Kodu Order Code	W (mm)	T (mm)	Ağırlık (kg/ad) Weight (kg/pcs)	Barkod Kodu Barcode Code
50 AAU 100D	100	1.00 mm	0,700	2005950
50 AAU 150D	150	1.00 mm	0,950	2005951
50 AAU 200D	200	1.00 mm	1,240	2005952
50 AAU 300D	300	1.00 mm	1,940	2005953
50 AAU 400D	400	1.00 mm	2,800	2005954
50 AAU 500D	500	1.00 mm	3,660	2005955

H60

Sipariş Kodu Order Code	W (mm)	T (mm)	Ağırlık (kg/ad) Weight (kg/pcs)	Barkod Kodu Barcode Code
60 AAU 100D	100	1.00 mm	0,780	2006000
60 AAU 150D	150	1.00 mm	1,050	2006001
60 AAU 200D	200	1.00 mm	1,360	2006002
60 AAU 300D	300	1.00 mm	2,080	2006003
60 AAU 400D	400	1.00 mm	2,970	2006004
60 AAU 500D	500	1.00 mm	3,860	2006005

H100

Sipariş Kodu Order Code	W (mm)	T (mm)	Ağırlık (kg/ad) Weight (kg/pcs)	Barkod Kodu Barcode Code
100 AAU 100D	100	1.00 mm	1,700	2006050
100 AAU 150D	150	1.00 mm	2,241	2006051
100 AAU 200D	200	1.00 mm	2,642	2006052
100 AAU 300D	300	1.00 mm	3,793	2006053
100 AAU 400D	400	1.00 mm	5,150	2006054

H = YÜKSEKLİK = HEIGHT / W = GENİŞLİK = WIDTH / T = KALINLIK = THICKNESS

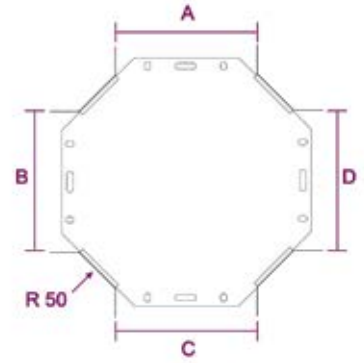
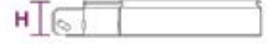
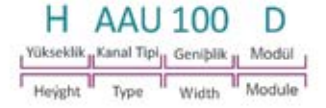

Dönüşlerde "A-B-C-D" ölçüleri esit olarak üretilmektedir. İsteğe bağlı olarak farklı ölçülerde üretim yapılır. Bends are produced same dimension for "A-B-C-D" as well as we can produce special dimensions regarding your inquiry.

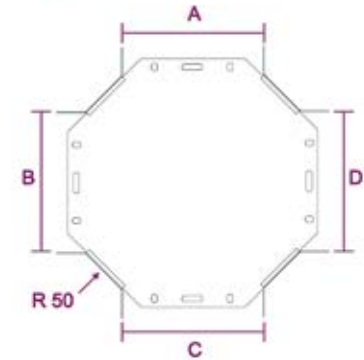

ARTIM METAL ELEKTRİK A.Ş.

- * Farklı kalınlık ve ölçülerde üretim yapıyla bilinir
- * Malzeme ağırlıklarını yaklaşık değerlerdir ± %10 deñişlik gösterebilir.
- * Malzeme kalınlık toleransı ± %10 dur
- * Lütfen siparişlerinizde sipariş kodu veya ürün kodu ve kaplama beklini belirtiniz.

- * We can produce cable trays different thickness and dimensions
- * Cable trays are shown approximately weight, they could change ± %10 difference.
- * Cable trays thickness tolerances are shown ± %10 .
- * Please indicate order code and coating type in your orders.

AAU SERIES

DÖRTLÜ BAGLANTI (GOLD FORMLU TIP)

FOUR WAY CROSSING (GOLD FORMED TYPE)

SICAK DALDIRMA (SD)
HOT DIP GALVANIZED (SD)
TS EN ISO 1461



H40 = H50 = H60 Tek delikli
H40 = H50 = H60 One hole



H40				
Sipariş Kodu Order Code	W (mm)	T (mm)	Ağırlık (kg/ad) Weight (kg/pcs)	Barkod Kodu Barcode Code
40 AAU 100D	100	1.20 mm	0,790	2005900
40 AAU 150D	150	1.20 mm	1,102	2005901
40 AAU 200D	200	1.20 mm	1,464	2005902
40 AAU 300D	300	1.20 mm	2,333	2005903
40 AAU 400D	400	1.20 mm	3,408	2005904
40 AAU 500D	500	1.20 mm	4,483	2005905

H50				
Sipariş Kodu Order Code	W (mm)	T (mm)	Ağırlık (kg/ad) Weight (kg/pcs)	Barkod Kodu Barcode Code
50 AAU 100D	100	1.20 mm	0,907	2005950
50 AAU 150D	150	1.20 mm	1,231	2005951
50 AAU 200D	200	1.20 mm	1,607	2005952
50 AAU 300D	300	1.20 mm	2,514	2005953
50 AAU 400D	400	1.20 mm	3,629	2005954
50 AAU 500D	500	1.20 mm	4,744	2005955

H60				
Sipariş Kodu Order Code	W (mm)	T (mm)	Ağırlık (kg/ad) Weight (kg/pcs)	Barkod Kodu Barcode Code
60 AAU 100D	100	1.20 mm	1,011	2006000
60 AAU 150D	150	1.20 mm	1,360	2006001
60 AAU 200D	200	1.20 mm	1,763	2006002
60 AAU 300D	300	1.20 mm	2,696	2006003
60 AAU 400D	400	1.20 mm	3,849	2006004
60 AAU 500D	500	1.20 mm	5,002	2006005

H100				
Sipariş Kodu Order Code	W (mm)	T (mm)	Ağırlık (kg/ad) Weight (kg/pcs)	Barkod Kodu Barcode Code
100 AAU 100D	100	1.20 mm	2,244	2006050
100 AAU 150D	150	1.20 mm	2,958	2006051
100 AAU 200D	200	1.20 mm	3,487	2006052
100 AAU 300D	300	1.20 mm	5,006	2006053
100 AAU 400D	400	1.20 mm	6,798	2006054

H = YÜKSEKLİK = HEIGHT / W = GENİŞLİK = WIDTH / T = KALINLIK = THICKNESS

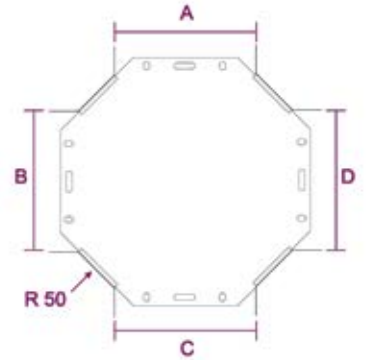
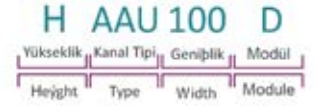

Dörtlülerde "A-B-C-D" ölçüleri esit olarak üretilmektedir. İsteğe bağlı olarak farklı ölçülerde üretim yapılır. Bends are produced same dimension for "A-B-C-D" as well as we can produce special dimensions regarding your inquiry.

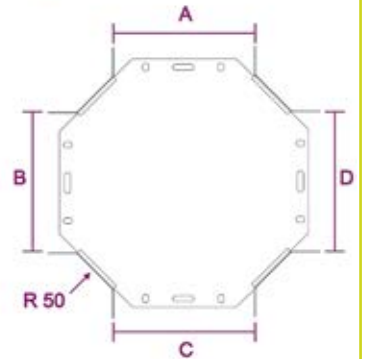
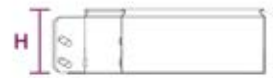

* Farklı kalınlık ve ölçülerde üretim yapıla bilinir
* Malzeme ağırlıklarını yaklaşık değerlerdir ± %10 değişiklik gösterebilir.
* Malzeme kalınlık toleransı ± %10 dur
* Lütfen siparişlerinizde sipariş kodu veya ürün kodu ve kaplama beklini belirtiniz.

* We can produce cable trays different thickness and dimensions
* Cable trays are shown approximately weight, they could change ± %10 difference.
* Cable trays thickness tolerances are shown ± %10 .
* Please indicate order code and coating type in your orders.

AAU SERIES

45° DÖNÜŞ (GOLD FORMLU TIP)

45° BEND (GOLD FORMED TYPE)

PREGALVANİZ (PG)
PREGALVANIZED (PG)
TS EN 10346



H40 = H50 = H60 Tek delikli
H40 = H50 = H60 One hole



H40

Sipariş Kodu Order Code	W (mm)	T (mm)	Ağırlık (kg/ad) Weight (kg/pcs)	Barkod Kodu Barcode Code
40 AAU 100Y (45°)	100	1.00 mm	0,370	2006100
40 AAU 150Y (45°)	150	1.00 mm	0,560	2006101
40 AAU 200Y (45°)	200	1.00 mm	0,790	2006102
40 AAU 300Y (45°)	300	1.00 mm	1,360	2006103
40 AAU 400Y (45°)	400	1.00 mm	2,100	2006104
40 AAU 500Y (45°)	500	1.00 mm	2,840	2006105

H50

Sipariş Kodu Order Code	W (mm)	T (mm)	Ağırlık (kg/ad) Weight (kg/pcs)	Barkod Kodu Barcode Code
50 AAU 100Y (45°)	100	1.00 mm	0,390	2006150
50 AAU 150Y (45°)	150	1.00 mm	0,590	2006151
50 AAU 200Y (45°)	200	1.00 mm	0,830	2006152
50 AAU 300Y (45°)	300	1.00 mm	1,420	2006153
50 AAU 400Y (45°)	400	1.00 mm	2,170	2006154
50 AAU 500Y (45°)	500	1.00 mm	3,460	2006155

H60

Sipariş Kodu Order Code	W (mm)	T (mm)	Ağırlık (kg/ad) Weight (kg/pcs)	Barkod Kodu Barcode Code
60 AAU 100Y (45°)	100	1.00 mm	0,420	2006200
60 AAU 150Y (45°)	150	1.00 mm	0,630	2006201
60 AAU 200Y (45°)	200	1.00 mm	0,870	2006202
60 AAU 300Y (45°)	300	1.00 mm	1,480	2006203
60 AAU 400Y (45°)	400	1.00 mm	2,250	2006204
60 AAU 500Y (45°)	500	1.00 mm	3,020	2006205

H100

Sipariş Kodu Order Code	W (mm)	T (mm)	Ağırlık (kg/ad) Weight (kg/pcs)	Barkod Kodu Barcode Code
100 AAU 100Y (45°)	100	1.00 mm	0,530	2006250
100 AAU 150Y (45°)	150	1.00 mm	0,770	2006251
100 AAU 200Y (45°)	200	1.00 mm	1,050	2006252
100 AAU 300Y (45°)	300	1.00 mm	1,720	2006253
100 AAU 400Y (45°)	400	1.00 mm	2,550	2006254

H = YÜKSEKLİK = HEIGHT / W = GENİŞLİK = WIDTH / T = KALINLIK = THICKNESS

H AAU 100 Y (45°)

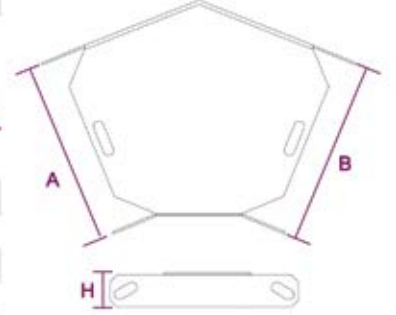
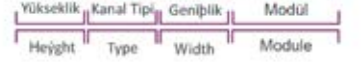

Donüşlerde "A-B" ölçüleri esit olarak üretilmektedir. İsteğe bağlı olarak farklı ölçülerde üretim yapılır. Bends are produced same dimension for "A-B" as well as we can produce special dimensions regarding your inquiry.

ARTIM METAL ELEKTRİK A.Ş.

* Farklı kalınlık ve ölçülerde üretim yapıla bilinir
* Malzeme ağırlıkları yaklaşık değerlerdir ± %10 deüpipiklik gösterebilir.
* Malzeme kalınlık toleransı ± %10 dur
* Lütfen siparişlerinizde sipariş kodu veya ürün kodu ve kaplama beklini belirtiniz.

* We can produce cable trays different thickness and dimensions
* Cable trays are shown approximately weight, they could change ± %10 difference.
* Cable trays thickness tolerances are shown ± %10 .
* Please indicate order code and coating type in your orders.

AAU SERIES

45° DÖNÜS (GOLD FORMLU TIP)

45° BEND (GOLD FORMED TYPE)

SICAK DALDIRMA (SD)

HOT DIP GALVANIZED (SD)

TS EN ISO 1461



H40 = H50 = H60 Tek delikli
H40 = H50 = H60 One hole



H40

Sipariş Kodu Order Code	W (mm)	T (mm)	Ağırlık (kg/ad) Weight (kg/pcs)	Barkod Kodu Barcode Code
40 AAU 100Y (45°)	100	1.20 mm	0,488	2006100
40 AAU 150Y (45°)	150	1.20 mm	0,739	2006101
40 AAU 200Y (45°)	200	1.20 mm	1,043	2006102
40 AAU 300Y (45°)	300	1.20 mm	1,795	2006103
40 AAU 400Y (45°)	400	1.20 mm	2,772	2006104
40 AAU 500Y (45°)	500	1.20 mm	3,785	2006105

H50

Sipariş Kodu Order Code	W (mm)	T (mm)	Ağırlık (kg/ad) Weight (kg/pcs)	Barkod Kodu Barcode Code
50 AAU 100Y (45°)	100	1.20 mm	0,514	2006150
50 AAU 150Y (45°)	150	1.20 mm	0,779	2006151
50 AAU 200Y (45°)	200	1.20 mm	1,095	2006152
50 AAU 300Y (45°)	300	1.20 mm	1,874	2006153
50 AAU 400Y (45°)	400	1.20 mm	2,864	2006154
50 AAU 500Y (45°)	500	1.20 mm	3,854	2006155

H60

Sipariş Kodu Order Code	W (mm)	T (mm)	Ağırlık (kg/ad) Weight (kg/pcs)	Barkod Kodu Barcode Code
60 AAU 100Y (45°)	100	1.20 mm	0,554	2006200
60 AAU 150Y (45°)	150	1.20 mm	0,832	2006201
60 AAU 200Y (45°)	200	1.20 mm	1,148	2006202
60 AAU 300Y (45°)	300	1.20 mm	1,954	2006203
60 AAU 400Y (45°)	400	1.20 mm	2,970	2006204
60 AAU 500Y (45°)	500	1.20 mm	3,986	2006205

H100

Sipariş Kodu Order Code	W (mm)	T (mm)	Ağırlık (kg/ad) Weight (kg/pcs)	Barkod Kodu Barcode Code
100 AAU 100Y (45°)	100	1.20 mm	0,700	2006250
100 AAU 150Y (45°)	150	1.20 mm	1,016	2006251
100 AAU 200Y (45°)	200	1.20 mm	1,386	2006252
100 AAU 300Y (45°)	300	1.20 mm	2,270	2006253
100 AAU 400Y (45°)	400	1.20 mm	3,366	2006254

H = YÜKSEKLİK = HEIGHT / W = GENİŞLİK = WIDTH / T = KALINLIK = THICKNESS

H AAU 100 Y (45°)

Yükseklik Kanal Tipi Geniçlik Modül
Height Type Width Module

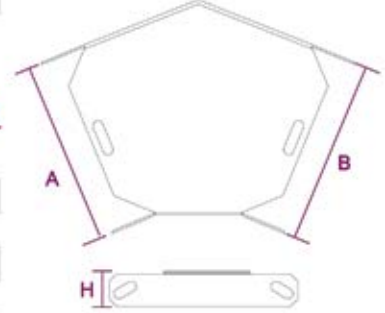

Dönüşlerde "A-B" ölçüleri eşit olarak üretilmektedir. İsteğe bağlı olarak farklı ölçülerde üretim yapılır. Bends are produced same dimension for "A-B" as well as we can produce special dimensions regarding your inquiry.

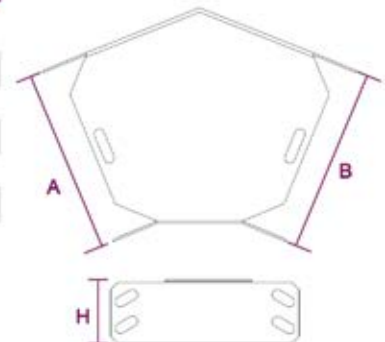

- Farklı kalınlık ve ölçülerde üretim yapıla bilinir
- Malzeme ağırlıklarını yaklaşık değerlerdir ± %10 değişiklik gösterebilir.
- Malzeme kalınlık toleransı ± %10 dur
- Lütfen siparişlerinizde sipariş kodu veya ürün kodu ve kaplama beklini belirtiniz.

- We can produce cable trays different thickness and dimensions
- Cable trays are shown approximately weight, they could change ± %10 difference.
- Cable trays thickness tolerances are shown ± %10 .
- Please indicate order code and coating type in your orders.

AAU SERIES

YARIM T BAĞLANTI (GOLD FORMLU TIP)

ADD-ON TEES (GOLD FORMED TYPE)

PREGALVANIZ (PG)
PREGALVANIZED (PG)
TS EN 10346



H40 = H50 = H60 Tek delikli
H40 = H50 = H60 One hole



ARTIM METAL ELEKTRİK A.Ş.

H40

Sipariş Kodu Order Code	W (mm)	T (mm)	Ağırlık (kg/ad) Weight (kg/pcs)	Barkod Kodu Barcode Code
40 AAU 100TT	100	1.00 mm	0,300	2006400
40 AAU 150TT	150	1.00 mm	0,360	2006401
40 AAU 200TT	200	1.00 mm	0,410	2006402
40 AAU 300TT	300	1.00 mm	0,520	2006403
40 AAU 400TT	400	1.00 mm	0,750	2006404
40 AAU 500TT	500	1.00 mm	0,980	2006405

H50

Sipariş Kodu Order Code	W (mm)	T (mm)	Ağırlık (kg/ad) Weight (kg/pcs)	Barkod Kodu Barcode Code
50 AAU 100TT	100	1.00 mm	0,350	2006450
50 AAU 150TT	150	1.00 mm	0,410	2006451
50 AAU 200TT	200	1.00 mm	0,470	2006452
50 AAU 300TT	300	1.00 mm	0,590	2006453
50 AAU 400TT	400	1.00 mm	0,710	2006454
50 AAU 500TT	500	1.00 mm	0,830	2006455

H60

Sipariş Kodu Order Code	W (mm)	T (mm)	Ağırlık (kg/ad) Weight (kg/pcs)	Barkod Kodu Barcode Code
60 AAU 100TT	100	1.00 mm	0,368	2006500
60 AAU 150TT	150	1.00 mm	0,431	2006501
60 AAU 200TT	200	1.00 mm	0,493	2006502
60 AAU 300TT	300	1.00 mm	0,620	2006503
60 AAU 400TT	400	1.00 mm	0,746	2006504
60 AAU 500TT	500	1.00 mm	0,872	2006505

H100

Sipariş Kodu Order Code	W (mm)	T (mm)	Ağırlık (kg/ad) Weight (kg/pcs)	Barkod Kodu Barcode Code
100 AAU 100TT	100	1.00 mm	0,460	2006550
100 AAU 150TT	150	1.00 mm	0,540	2006551
100 AAU 200TT	200	1.00 mm	0,620	2006552
100 AAU 300TT	300	1.00 mm	0,780	2006553
100 AAU 400TT	400	1.00 mm	0,940	2006554

H = YÜKSEKLİK = HEIGHT / W = GENİŞLİK = WIDTH / T = KALINLIK = THICKNESS

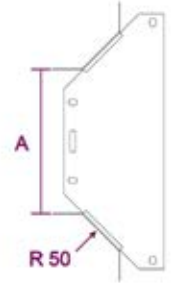

Dönüşlerde ölçüler esit olarak üretilmektedir. İsteğe bağlı olarak farklı ölçülerde üretim yapılır. Bends are produced same dimension for as well as we can produce special dimensions regarding your inquiry.

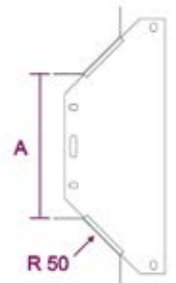

* Farklı kalınlık ve ölçülerde üretim yapıla bilinir
* Malzeme ağırlıklarını yaklaşık değerlerdir ± %10 deapiklik gösterebilir.
* Malzeme kalınlık toleransı ± %10 dur
* Lütfen siparişlerinizde sipariş kodu veya ürün kodu ve kaplama beklini belirtiniz.

* We can produce cable trays different thickness and dimensions
* Cable trays are shown approximately weight, they could change ± %10 difference.
* Cable trays thickness tolerances are shown ± %10 .
* Please indicate order code and coating type in your orders.

AAU SERIES

YARIM T BAGLANTI (GOLD FORMLU TIP)

ADD-ON TEES(GOLD FORMED TYPE)

SICAK DALDIRMA (SD)

HOT DIP GALVANIZED (SD)

TS EN ISO 1461



H40

Sipariş Kodu Order Code	W (mm)	T (mm)	Ağırlık (kg/ad) Weight (kg/pcs)	Barkod Kodu Barcode Code
40 AAU 100TT	100	1.20 mm	0,396	2006400
40 AAU 150TT	150	1.20 mm	0,475	2006401
40 AAU 200TT	200	1.20 mm	0,541	2006402
40 AAU 300TT	300	1.20 mm	0,686	2006403
40 AAU 400TT	400	1.20 mm	0,990	2006404
40 AAU 500TT	500	1.20 mm	1,320	2006405

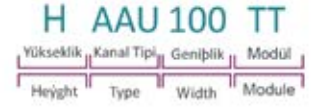

H40 = H50 = H60 Tek delikli
H40 = H50 = H60 One hole

H50

Sipariş Kodu Order Code	W (mm)	T (mm)	Ağırlık (kg/ad) Weight (kg/pcs)	Barkod Kodu Barcode Code
50 AAU 100TT	100	1.20 mm	0,462	2006450
50 AAU 150TT	150	1.20 mm	0,541	2006451
50 AAU 200TT	200	1.20 mm	0,620	2006452
50 AAU 300TT	300	1.20 mm	0,780	2006453
50 AAU 400TT	400	1.20 mm	0,937	2006454
50 AAU 500TT	500	1.20 mm	1,094	2006455

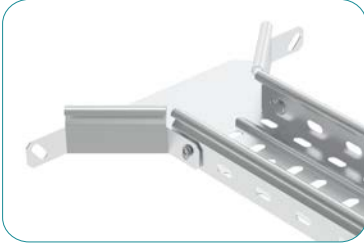
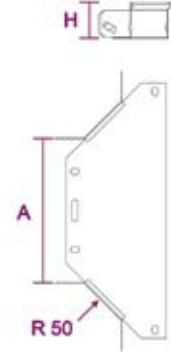

H60

Sipariş Kodu Order Code	W (mm)	T (mm)	Ağırlık (kg/ad) Weight (kg/pcs)	Barkod Kodu Barcode Code
60 AAU 100TT	100	1.20 mm	0,485	2006500
60 AAU 150TT	150	1.20 mm	0,568	2006501
60 AAU 200TT	200	1.20 mm	0,651	2006502
60 AAU 300TT	300	1.20 mm	0,819	2006503
60 AAU 400TT	400	1.20 mm	0,984	2006504
60 AAU 500TT	500	1.20 mm	1,149	2006505

Dönüşlerde ölçüler esit olarak üretilmektedir. İsteğe bağlı olarak farklı ölçülerde üretim yapılır. Bends are produced same dimension for as well as we can produce special dimensions regarding your inquiry.

H100

Sipariş Kodu Order Code	W (mm)	T (mm)	Ağırlık (kg/ad) Weight (kg/pcs)	Barkod Kodu Barcode Code
100 AAU 100TT	100	1.20 mm	0,607	2006550
100 AAU 150TT	150	1.20 mm	0,712	2006551
100 AAU 200TT	200	1.20 mm	0,818	2006552
100 AAU 300TT	300	1.20 mm	1,030	2006553
100 AAU 400TT	400	1.20 mm	1,241	2006554



H = YÜKSEKLİK = HEIGHT / W = GENİŞLİK = WIDTH / T = KALINLIK = THICKNESS



* Farklı kalınlık ve ölçülerde üretim yapıla bilinir
* Malzeme ağırlıklarını yaklaşık değerlerdir ± %10 değişiklik gösterebilir.
* Malzeme kalınlık toleransı ± %10 dur
* Lütfen siparişlerinizde sipariş kodu veya ürün kodu ve kaplama beklini belirtiniz.

* We can produce cable trays different thickness and dimensions
* Cable trays are shown approximately weight, they could change ± %10 difference.
* Cable trays thickness tolerances are shown ± %10 .
* Please indicate order code and coating type in your orders.

AAU SERIES

REDÜKSİYON (GOLD FORMLU TIP)

REDUCING ANGLES (GOLD FORMED TYPE)

PREGALVANİZ (PG)
PREGALVANIZED (PG)
TS EN 10346



H40 = H50 = H60 Tek delikli
H40 = H50 = H60 One hole



ARTIM METAL ELEKTRİK A.Ş.

H40

Sipariş Kodu Order Code	W (mm)	T (mm)	Ağırlık (kg/ad) Weight (kg/pcs)	Barkod Kodu Barcode Code
40 AAU 100R	50/100	1.00 mm	0,820	2006600
40 AAU 150R	100/150	1.00 mm	0,910	2006601
40 AAU 200R	150/200	1.00 mm	1,060	2006602
40 AAU 300R	200/300	1.00 mm	1,220	2006603
40 AAU 400R	300/400	1.00 mm	1,520	2006604

H50

Sipariş Kodu Order Code	W (mm)	T (mm)	Ağırlık (kg/ad) Weight (kg/pcs)	Barkod Kodu Barcode Code
50 AAU 100R	50/100	1.00 mm	0,850	2006650
50 AAU 150R	100/150	1.00 mm	0,950	2006651
50 AAU 200R	150/200	1.00 mm	1,110	2006652
50 AAU 300R	200/300	1.00 mm	1,260	2006653
50 AAU 400R	300/400	1.00 mm	1,580	2006654

H60

Sipariş Kodu Order Code	W (mm)	T (mm)	Ağırlık (kg/ad) Weight (kg/pcs)	Barkod Kodu Barcode Code
60 AAU 100R	50/100	1.00 mm	0,980	2006700
60 AAU 150R	100/150	1.00 mm	1,150	2006701
60 AAU 200R	150/200	1.00 mm	1,310	2006702
60 AAU 300R	200/300	1.00 mm	1,640	2006703
60 AAU 400R	300/400	1.00 mm	1,970	2006704

H100

Sipariş Kodu Order Code	W (mm)	T (mm)	Ağırlık (kg/ad) Weight (kg/pcs)	Barkod Kodu Barcode Code
100 AAU 100R	-/100	1.00 mm	1,120	2006750
100 AAU 150R	100/150	1.00 mm	1,310	2006751
100 AAU 200R	150/200	1.00 mm	1,500	2006752
100 AAU 300R	200/300	1.00 mm	1,870	2006753
100 AAU 400R	300/400	1.00 mm	2,250	2006754

H = YÜKSEKLİK = HEIGHT / W = GENİŞLİK = WIDTH / T = KALINLIK = THICKNESS

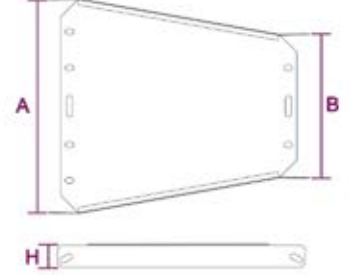

Donüşlerde "A-B" ölçüleri esit olarak üretilmektedir. İsteğe bağlı olarak farklı ölçülerde üretim yapılır. Bends are produced same dimension for "A-B" as well as we can produce special dimensions regarding your inquiry.

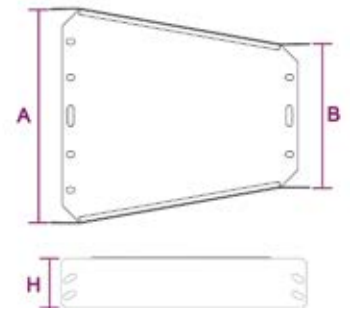

* Farklı kalınlık ve ölçülerde üretim yapıla bilinir
* Malzeme ağırlıklarını yaklaşık değerlerdir %10 deñişlik gösterebilir.
* Malzeme kalınlık toleransı ± %10 dur
* Lütfen siparişlerinizde sipariş kodu veya ürün kodu ve kaplama beklini belirtiniz.

• We can produce cable trays different thickness and dimensions
• Cable trays are shown approximately weight, they could change ± %10 difference.
• Cable trays thickness tolerances are shown ± %10 .
• Please indicate order code and coating type in your orders.

AAU SERIES

REDÜKSİYON (GOLD FORMLU TIP)

REDUCING ANGLES (GOLD FORMED TYPE)

SICAK DALDIRMA (SD)
HOT DIP GALVANIZED (SD)
TS EN ISO 1461



H40 = H50 = H60 Tek delikli
H40 = H50 = H60 One hole



H40

Sipariş Kodu Order Code	W (mm)	T (mm)	Ağırlık (kg/ad) Weight (kg/pcs)	Barkod Kodu Barcode Code
40 AAU 100R	50/100	1.20 mm	1,122	2006600
40 AAU 150R	100/150	1.20 mm	1,254	2006601
40 AAU 200R	150/200	1.20 mm	1,465	2006602
40 AAU 300R	200/300	1.20 mm	1,663	2006603
40 AAU 400R	300/400	1.20 mm	2,086	2006604

H50

Sipariş Kodu Order Code	W (mm)	T (mm)	Ağırlık (kg/ad) Weight (kg/pcs)	Barkod Kodu Barcode Code
50 AAU 100R	50/100	1.20 mm	1,152	2006650
50 AAU 150R	100/150	1.20 mm	1,284	2006651
50 AAU 200R	150/200	1.20 mm	1,495	2006652
50 AAU 300R	200/300	1.20 mm	1,693	2006653
50 AAU 400R	300/400	1.20 mm	2,116	2006654

H60

Sipariş Kodu Order Code	W (mm)	T (mm)	Ağırlık (kg/ad) Weight (kg/pcs)	Barkod Kodu Barcode Code
60 AAU 100R	50/100	1.20 mm	1,293	2006700
60 AAU 150R	100/150	1.20 mm	1,518	2006701
60 AAU 200R	150/200	1.20 mm	1,729	2006702
60 AAU 300R	200/300	1.20 mm	2,165	2006703
60 AAU 400R	300/400	1.20 mm	2,600	2006704

H100

Sipariş Kodu Order Code	W (mm)	T (mm)	Ağırlık (kg/ad) Weight (kg/pcs)	Barkod Kodu Barcode Code
100 AAU 100R	-/100	1.20 mm	1,478	2006750
100 AAU 150R	100/150	1.20 mm	1,729	2006751
100 AAU 200R	150/200	1.20 mm	1,980	2006752
100 AAU 300R	200/300	1.20 mm	2,468	2006753
100 AAU 400R	300/400	1.20 mm	2,970	2006754

H = YÜKSEKLİK = HEIGHT / W = GENİŞLİK = WIDTH / T = KALINLIK = THICKNESS

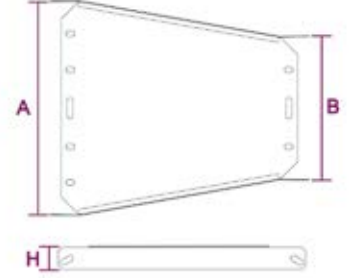
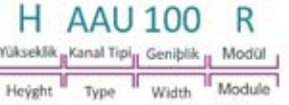

Dönüşlerde "A-B" ölçüleri eşit olarak üretilmektedir. İsteğe bağlı olarak farklı ölçülerde üretim yapılır.
Bends are produced same dimension for "A-B" as well as we can produce special dimensions regarding your inquiry.

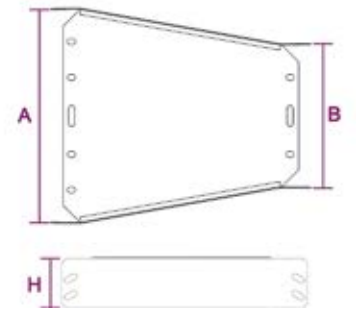

* Farklı kalınlık ve ölçülerde üretim yapıla bilinir
* Malzeme ağırlıklarını yaklaşık değerlerdir ± %10 değişiklik gösterebilir.
* Malzeme kalınlık toleransı ± %10 dur
* Lütfen siparişlerinizde sipariş kodu veya ürün kodu ve kaplama beklini belirtiniz.

* We can produce cable trays different thickness and dimensions
* Cable trays are shown approximately weight, they could change ± %10 difference.
* Cable trays thickness tolerances are shown ± %10 .
* Please indicate order code and coating type in your orders.

AAU SERIES

İÇ-DIŞ BÜKEY HAREKETLİ (GOLD FORMLU TIP)

ADJUSTABLE INSIDE-OUTSIDE VERTICAL (GOLD FORMED TYPE)

PREGALVANIZ (PG)
PREGALVANIZED (PG)
TS EN 10346



H40 = H50 = H60 Tek delikli
H40 = H50 = H60 One hole



H40

Sipariş Kodu Order Code	W (mm)	T (mm)	Ağırlık (kg/ad) Weight (kg/pcs)	Barkod Kodu Barcode Code
40 AAU 100B	100	1.00 mm	1,092	2006900
40 AAU 150B	150	1.00 mm	1,413	2006901
40 AAU 200B	200	1.00 mm	1,587	2006902
40 AAU 300B	300	1.00 mm	2,150	2006903
40 AAU 400B	400	1.00 mm	2,690	2006904
40 AAU 500B	500	1.00 mm	2,825	2006905

H50

Sipariş Kodu Order Code	W (mm)	T (mm)	Ağırlık (kg/ad) Weight (kg/pcs)	Barkod Kodu Barcode Code
50 AAU 100B	100	1.00 mm	1,203	2006906
50 AAU 150B	150	1.00 mm	1,527	2006907
50 AAU 200B	200	1.00 mm	1,693	2006908
50 AAU 300B	300	1.00 mm	2,258	2006909
50 AAU 400B	400	1.00 mm	2,798	2006910
50 AAU 500B	500	1.00 mm	2,920	2006911

H60

Sipariş Kodu Order Code	W (mm)	T (mm)	Ağırlık (kg/ad) Weight (kg/pcs)	Barkod Kodu Barcode Code
60 AAU 100B	100	1.00 mm	1,313	2006912
60 AAU 150B	150	1.00 mm	1,640	2006913
60 AAU 200B	200	1.00 mm	1,800	2006914
60 AAU 300B	300	1.00 mm	2,365	2006915
60 AAU 400B	400	1.00 mm	2,905	2006916
60 AAU 500B	500	1.00 mm	3,445	2006917

H100

Sipariş Kodu Order Code	W (mm)	T (mm)	Ağırlık (kg/ad) Weight (kg/pcs)	Barkod Kodu Barcode Code
100 AAU 100B	100	1.00 mm	1,384	2006917
100 AAU 150B	150	1.00 mm	1,759	2006918
100 AAU 200B	200	1.00 mm	1,999	2006919
100 AAU 300B	300	1.00 mm	2,448	2006920
100 AAU 400B	400	1.00 mm	2,886	2006921

H = YÜKSEKLİK = HEIGHT / W = GENİŞLİK = WIDTH / T = KALINLIK = THICKNESS

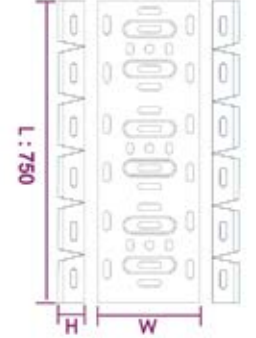
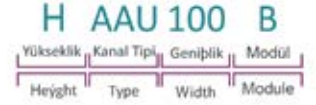

Dönüşlerde "A-B" ölçüleri esit olarak üretilmektedir. İsteğe bağlı olarak farklı ölçülerde üretim yapılır. Bends are produced same dimension for "A-B" as well as we can produce special dimensions regarding your inquiry.

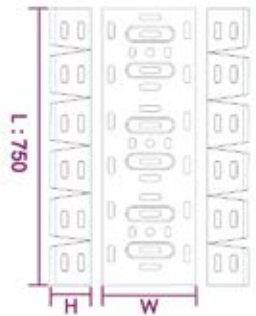

ARTIM METAL ELEKTRİK A.Ş.

* Farklı kalınlık ve ölçülerde üretim yapıla bilinir
* Malzeme ayrılıkları yaklaşık değerlerdir ± %10 deñişimlik gösterebilir.
* Malzeme kalınlık toleransı ± %10 dur
* Lütfen siparişlerinizde sipariş kodu veya ürün kodu ve kaplama beklini belirtiniz.

* We can produce cable trays different thickness and dimensions
* Cable trays are shown approximately weight, they could change ± %10 difference.
* Cable trays thickness tolerances are shown ± %10 .
* Please indicate order code and coating type in your orders.

AAU SERIES

İÇ-DİS BÜKEY HAREKETLİ (GOLD FORMLU TIP)

ADJUSTABLE INSIDE-OUTSIDE VERTICAL (GOLD FORMED TYPE)

SICAK DALDIRMA (SD)

HOT DIP GALVANIZED (SD)

TS EN ISO 1461



H40 = H50 = H60 Tek delikli
H40 = H50 = H60 One hole



H40

Sipariş Kodu Order Code	W (mm)	T (mm)	Ağırlık (kg/ad) Weight (kg/pcs)	Barkod Kodu Barcode Code
40 AAU 100B	100	1.20 mm	1,202	2006900
40 AAU 150B	150	1.20 mm	1,554	2006901
40 AAU 200B	200	1.20 mm	1,746	2006902
40 AAU 300B	300	1.20 mm	2,365	2006903
40 AAU 400B	400	1.20 mm	2,958	2006904
40 AAU 500B	500	1.20 mm	3,730	2006905

H50

Sipariş Kodu Order Code	W (mm)	T (mm)	Ağırlık (kg/ad) Weight (kg/pcs)	Barkod Kodu Barcode Code
50 AAU 100B	100	1.20 mm	1,323	2006906
50 AAU 150B	150	1.20 mm	1,679	2006907
50 AAU 200B	200	1.20 mm	1,863	2006908
50 AAU 300B	300	1.20 mm	2,483	2006909
50 AAU 400B	400	1.20 mm	3,077	2006910
50 AAU 500B	500	1.20 mm	3,855	2006911

H60

Sipariş Kodu Order Code	W (mm)	T (mm)	Ağırlık (kg/ad) Weight (kg/pcs)	Barkod Kodu Barcode Code
60 AAU 100B	100	1.20 mm	1,444	2006912
60 AAU 150B	150	1.20 mm	1,804	2006913
60 AAU 200B	200	1.20 mm	1,980	2006914
60 AAU 300B	300	1.20 mm	2,602	2006915
60 AAU 400B	400	1.20 mm	3,196	2006916
60 AAU 500B	500	1.20 mm	3,790	2006917

H100

Sipariş Kodu Order Code	W (mm)	T (mm)	Ağırlık (kg/ad) Weight (kg/pcs)	Barkod Kodu Barcode Code
100 AAU 100B	100	1.20 mm	1,522	2006917
100 AAU 150B	150	1.20 mm	1,935	2006918
100 AAU 200B	200	1.20 mm	2,198	2006919
100 AAU 300B	300	1.20 mm	2,692	2006920
100 AAU 400B	400	1.20 mm	3,683	2006921

H = YÜKSEKLİK = HEIGHT / W = GENİŞLİK = WIDTH / T = KALINLIK = THICKNESS

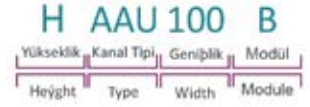

Dönüşlerde "A-B" ölçüleri esit olarak üretilmektedir. İsteğe bağlı olarak farklı ölçülerde üretim yapılır. Bends are produced same dimension for "A-B" as well as we can produce special dimensions regarding your inquiry.



* Farklı kalınlık ve ölçülerde üretim yapıla bilinir
* Malzeme ağırlıkları yaklaşık değerlerdir ± %10 değişiklik gösterebilir.
* Malzeme kalınlık toleransı ± %10 dur
* Lütfen siparişlerinizde sipariş kodu veya ürün kodu ve kaplama beklini belirtiniz.

* We can produce cable trays different thickness and dimensions
* Cable trays are shown approximately weight, they could change ± %10 difference.
* Cable trays thickness tolerances are shown ± %10 .
* Please indicate order code and coating type in your orders.

AAU SERIES

EK ELEMANI (GOLD FORMLU TIP)

STRAIGHT CONNECTION COUPLER (GOLD FORMED TYPE)

PREGALVANIZ (PG)

PREGALVANIZED (PG)

TS EN 10346



H40 = H50 = H60 Tek delikli
H40 = H50 = H60 One hole



H40				
Sipariş Kodu Order Code	L (mm)	T (mm)	Ağırlık (kg/ad) Weight (kg/pcs)	Barkod Kodu Barcode Code
40 AUST	210	1.00 mm	0,065	2001026



H50				
Sipariş Kodu Order Code	L (mm)	T (mm)	Ağırlık (kg/ad) Weight (kg/pcs)	Barkod Kodu Barcode Code
50 AUST	210	1.00 mm	0,078	2001027



H60				
Sipariş Kodu Order Code	L (mm)	T (mm)	Ağırlık (kg/ad) Weight (kg/pcs)	Barkod Kodu Barcode Code
60 AUST	210	1.00 mm	0,095	2001028



H100				
Sipariş Kodu Order Code	L (mm)	T (mm)	Ağırlık (kg/ad) Weight (kg/pcs)	Barkod Kodu Barcode Code
100 AUST	210	1.00 mm	0,165	2001029

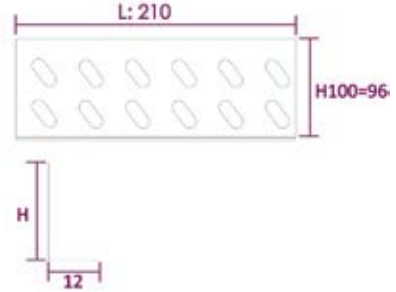

SICAK DALDIRMA (SD)

HOT DIP GALVANIZED (SD)

TS EN ISO 1461



H40				
Sipariş Kodu Order Code	L (mm)	T (mm)	Ağırlık (kg/ad) Weight (kg/pcs)	Barkod Kodu Barcode Code
40 AUST	210	1.20 mm	0,072	2001026



H50				
Sipariş Kodu Order Code	L (mm)	T (mm)	Ağırlık (kg/ad) Weight (kg/pcs)	Barkod Kodu Barcode Code
50 AUST	210	1.20 mm	0,085	2001027



H60				
Sipariş Kodu Order Code	L (mm)	T (mm)	Ağırlık (kg/ad) Weight (kg/pcs)	Barkod Kodu Barcode Code
60 AUST	210	1.20 mm	0,125	2001028

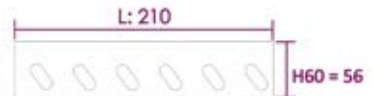

H100				
Sipariş Kodu Order Code	L (mm)	T (mm)	Ağırlık (kg/ad) Weight (kg/pcs)	Barkod Kodu Barcode Code
100 AUST	210	1.20 mm	0,220	2001029

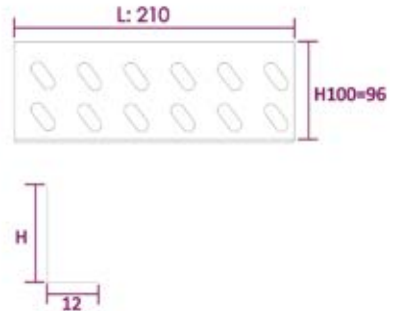

H = YÜKSEKLİK = HEIGHT / L= UZUNLUK = LENGTH / T = KALINLIK = THICKNESS

ARTIM METAL ELEKTRİK A.Ş.

- * Farklı kalınlık ve ölçülerde üretim yapıla bilinir
- * Malzeme ayrırlıkları yaklaşık değerlerdir ± %10 deüipiklik gösterebilir.
- * Malzeme kalınlık toleransı ± %10 dur
- * Lütfen siparişlerinizde sipariş kodu veya ürün kodu ve kaplama beklini belirtiniz.

- * We can produce cable trays different thickness and dimensions
- * Cable trays are shown approximately weight, they could change ± %10 difference.
- * Cable trays thickness tolerances are shown ± %10 .
- * Please indicate order code and coating type in your orders.

art

POWER CARRYING SOLUTIONS



AĞIR HİZMET & STANDART TİP KABLO KANALLARI

HEAVY DUTY & MEDIUM TYPE CABLE TRAYS

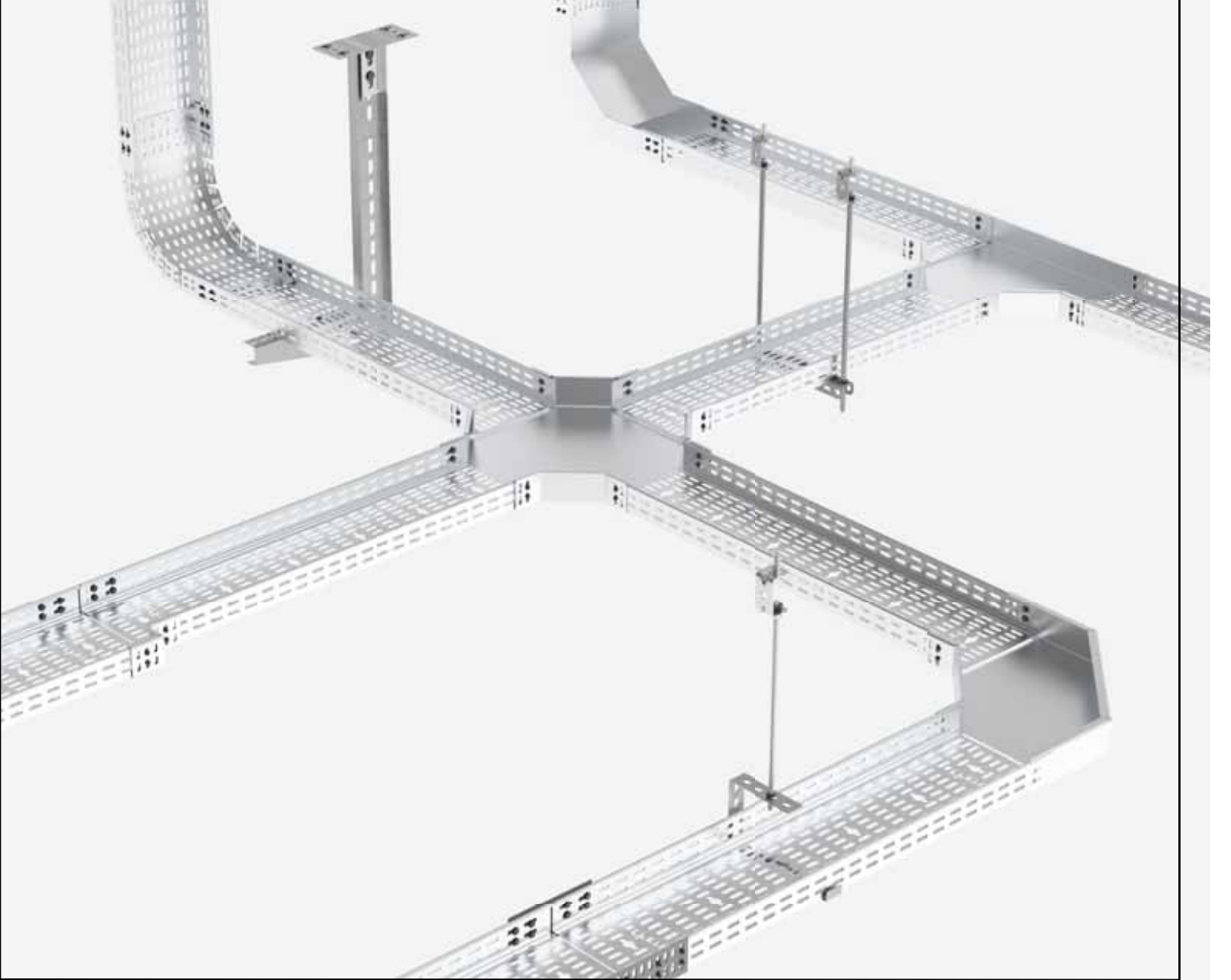

H40 AGH SERIES

AGIR HIZMET TIP KABLO KANALI

HEAVY DUTY TYPE CABLE TRAYS

PREGALVANIZ (PG)
PREGALVANIZED (PG)
TS EN 10346

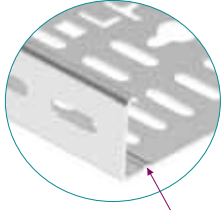

Güçlendirilmiş Büküm
Reinforced Bending

0.80 mm

Sipariş Kodu Order Code	W (mm)	T (mm)	Ağırlık (kg/m) Weight (kg/m)	Barkod Kodu Barcode Code
40 AGH 050-08	50	0.80 mm	0,779	2000301
40 AGH 100-08	100	0.80 mm	1,284	2000304
40 AGH 120-08	120	0.80 mm	1,132	2000382
40 AGH 160-08	160	0.80 mm	1,320	2000383
40 AGH 200-09	200	0.90 mm	1,877	2000310

1.00 mm

Sipariş Kodu Order Code	W (mm)	T (mm)	Ağırlık (kg/m) Weight (kg/m)	Barkod Kodu Barcode Code
40 AGH 050-10	50	1.00 mm	0,967	2000384
40 AGH 100-10	100	1.00 mm	1,282	2000385
40 AGH 120-10	120	1.00 mm	1,415	2000386
40 AGH 160-10	160	1.00 mm	1,650	2000387
40 AGH 200-10	200	1.00 mm	1,878	2000388
40 AGH 300-10	300	1.00 mm	2,470	2000313

1.20 mm

Sipariş Kodu Order Code	W (mm)	T (mm)	Ağırlık (kg/m) Weight (kg/m)	Barkod Kodu Barcode Code
40 AGH 050-12	50	1.20 mm	1,161	2000302
40 AGH 100-12	100	1.20 mm	1,539	2000305
40 AGH 120-12	120	1.20 mm	1,699	2000389
40 AGH 160-12	160	1.20 mm	1,980	2000308
40 AGH 200-12	200	1.20 mm	2,254	2000311
40 AGH 300-12	300	1.20 mm	2,965	2000314
40 AGH 400-12	400	1.20 mm	3,067	2000317
40 AGH 500-12	500	1.20 mm	3,690	2000320

1.50 mm

Sipariş Kodu Order Code	W (mm)	T (mm)	Ağırlık (kg/m) Weight (kg/m)	Barkod Kodu Barcode Code
40 AGH 050-15	50	1.50 mm	1,455	2000303
40 AGH 100-15	100	1.50 mm	1,926	2000306
40 AGH 120-15	120	1.50 mm	1,982	2000390
40 AGH 160-15	160	1.50 mm	2,480	2000309
40 AGH 200-15	200	1.50 mm	2,818	2000312
40 AGH 300-15	300	1.50 mm	3,709	2000315
40 AGH 400-15	400	1.50 mm	4,601	2000318
40 AGH 500-15	500	1.50 mm	5,493	2000321
40 AGH 600-15	600	1.50 mm	6,390	2000322

2.00 mm

Sipariş Kodu Order Code	W (mm)	T (mm)	Ağırlık (kg/m) Weight (kg/m)	Barkod Kodu Barcode Code
40 AGH 050-20	50	2.00 mm	1,974	2000391
40 AGH 100-20	100	2.00 mm	2,613	2000392
40 AGH 120-20	120	2.00 mm	2,689	2000393
40 AGH 160-20	160	2.00 mm	3,365	2000394
40 AGH 200-20	200	2.00 mm	3,824	2000395
40 AGH 300-20	300	2.00 mm	4,944	2000316
40 AGH 400-20	400	2.00 mm	6,135	2000319
40 AGH 500-20	500	2.00 mm	7,326	2000408
40 AGH 600-20	600	2.00 mm	8,511	2000409
40 AGH 700-20	700	2.00 mm	10,066	2000451
40 AGH 800-20	800	2.00 mm	11,334	2000452
40 AGH 900-20	900	2.00 mm	12,601	2000453

H = YÜKSEKLİK = HEIGHT / W = GENİŞLİK = WIDTH / T = KALINLIK = THICKNESS

40 AGH 100 - 10

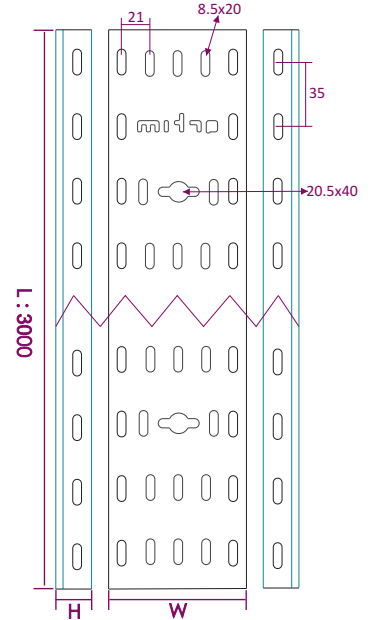
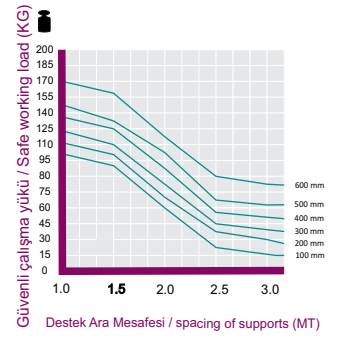

Standart uzunluk L:3000 mm
Toplu miktarlarda Özel ölçüler yapılabilir.
Standard Length L:3000 mm
Custom sizes can be made in bulk quantities.

ARTIM METAL ELEKTRİK A.Ş.

* Farklı kalınlık ve ölçülerde üretim yapılabılır.
* Malzeme ağırlıkları yaklaşık değerlerdir, ± %10 değişiklik gösterebilir.
* Malzeme kalınlık toleransı ± %10 dur.
* Lütfen siparişlerinizde sipariş kodu veya ürün kodu ve Kaplama şeklini belirtiniz.

* We can produce cable trays different thickness and dimensions
* Cable trays are shown approximately weight, they could change ± %10 difference.
* Cable trays thickness tolerances are shown ± %10 .
* Please indicate order code and coating type in your orders.

H40 AGH SERIES

AGIR HIZMET TIP KABLO KANALI

HEAVY DUTY TYPE CABLE TRAYS

SICAK DALDIRMA (SD)
HOT DIP GALVANIZED (HDG)
TS EN ISO 1461

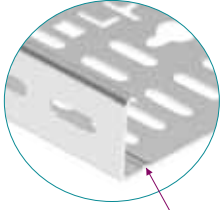

Güçlendirilmiş Büküm
Reinforced Bending

0.80 mm

Sipariş Kodu Order Code	W (mm)	T (mm)	Ağırlık (kg/m) Weight (kg/m)	Barkod Kodu Barcode Code
40 AGH 050-08	50	0.80 mm	0,996	2000301
40 AGH 100-08	100	0.80 mm	1,107	2000304
40 AGH 120-08	120	0.80 mm	1,222	2000382
40 AGH 160-08	160	0.80 mm	1,453	2000383
40 AGH 200-09	200	0.90 mm	1,652	2000310

1.00 mm

Sipariş Kodu Order Code	W (mm)	T (mm)	Ağırlık (kg/m) Weight (kg/m)	Barkod Kodu Barcode Code
40 AGH 050-10	50	1.00 mm	1,245	2000384
40 AGH 100-10	100	1.00 mm	1,384	2000385
40 AGH 120-10	120	1.00 mm	1,528	2000386
40 AGH 160-10	160	1.00 mm	1,817	2000387
40 AGH 200-10	200	1.00 mm	2,065	2000388
40 AGH 300-10	300	1.00 mm	2,720	2000313

1.20 mm

Sipariş Kodu Order Code	W (mm)	T (mm)	Ağırlık (kg/m) Weight (kg/m)	Barkod Kodu Barcode Code
40 AGH 050-12	50	1.20 mm	1,495	2000302
40 AGH 100-12	100	1.20 mm	1,661	2000305
40 AGH 120-12	120	1.20 mm	1,834	2000389
40 AGH 160-12	160	1.20 mm	2,181	2000308
40 AGH 200-12	200	1.20 mm	2,479	2000311
40 AGH 300-12	300	1.20 mm	3,263	2000314
40 AGH 400-12	400	1.20 mm	3,376	2000317
40 AGH 500-12	500	1.20 mm	4,062	2000320

1.50 mm

Sipariş Kodu Order Code	W (mm)	T (mm)	Ağırlık (kg/m) Weight (kg/m)	Barkod Kodu Barcode Code
40 AGH 050-15	50	1.50 mm	1,507	2000303
40 AGH 100-15	100	1.50 mm	2,122	2000306
40 AGH 120-15	120	1.50 mm	2,139	2000390
40 AGH 160-15	160	1.50 mm	2,729	2000309
40 AGH 200-15	200	1.50 mm	3,102	2000312
40 AGH 300-15	300	1.50 mm	4,082	2000315
40 AGH 400-15	400	1.50 mm	5,062	2000318
40 AGH 500-15	500	1.50 mm	6,042	2000321
40 AGH 600-15	600	1.50 mm	7,032	2000322

2.00 mm

Sipariş Kodu Order Code	W (mm)	T (mm)	Ağırlık (kg/m) Weight (kg/m)	Barkod Kodu Barcode Code
40 AGH 050-20	50	2.00 mm	2,045	2000391
40 AGH 100-20	100	2.00 mm	2,879	2000392
40 AGH 120-20	120	2.00 mm	2,903	2000393
40 AGH 160-20	160	2.00 mm	3,703	2000394
40 AGH 200-20	200	2.00 mm	4,209	2000395
40 AGH 300-20	300	2.00 mm	5,439	2000316
40 AGH 400-20	400	2.00 mm	6,752	2000319
40 AGH 500-20	500	2.00 mm	8,061	2000408
40 AGH 600-20	600	2.00 mm	9,364	2000409
40 AGH 700-20	700	2.00 mm	11,073	2000451
40 AGH 800-20	800	2.00 mm	12,467	2000452
40 AGH 900-20	900	2.00 mm	13,861	2000453

H = YÜKSEKLİK = HEIGHT / W = GENİŞLİK = WIDTH / T = KALINLIK = THICKNESS

40 AGH 100-10

Yükseklik Kanal Tipi Genişlik Kalınlık
Height Type Width Thickness

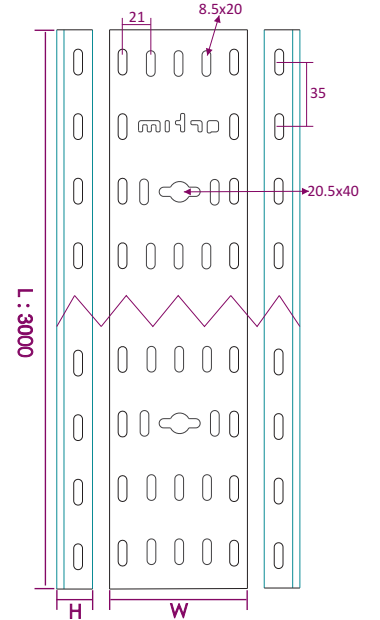
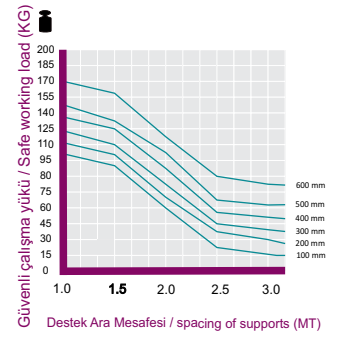

Standart uzunluk L:3000 mm
Toplu miktarlarda Özel ölçüler yapılabilir.
Standard Length L:3000 mm
Custom sizes can be made in bulk quantities.

* Farklı kalınlık ve ölçülerde üretim yapılabılır.
* Malzeme ağırlıkları yaklaşık değerlerdir, \pm %10 değişiklik gösterebilir.
* Malzeme kalınlık toleransı \pm %10 dur.
* Lütfen siparişlerinizde sipariş kodu veya ürün kodu ve Kaplama şeklini belirtiniz.

* We can produce cable trays different thickness and dimensions
* Cable trays are shown approximately weight, they could change \pm %10 difference.
* Cable trays thickness tolerances are shown \pm %10 .
* Please indicate order code and coating type in your orders.

H40 AGH SERIES

AGIR HIZMET TIP KABLO KANALI (DELIKSIZ)

HEAVY DUTY TYPE CABLE TRAYS (NON PERFORATED)

PREGALVANIZ (PG)

PREGALVANIZED (PG)

TS EN 10346

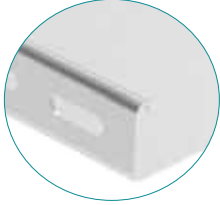

0.80 mm

Sipariş Kodu Order Code	W (mm)	T (mm)	Ağırlık (kg/m) Weight (kg/m)	Barkod Kodu Barcode Code
40 AGH 050-08D	50	0.80 mm	0,896	2000301
40 AGH 100-08D	100	0.80 mm	1,476	2000304
40 AGH 120-08D	120	0.80 mm	1,302	2000382
40 AGH 160-08D	160	0.80 mm	1,518	2000383
40 AGH 200-09D	200	0.90 mm	2,158	2000310

1.00 mm

Sipariş Kodu Order Code	W (mm)	T (mm)	Ağırlık (kg/m) Weight (kg/m)	Barkod Kodu Barcode Code
40 AGH 050-10D	50	1.00 mm	1,112	2000384
40 AGH 100-10D	100	1.00 mm	1,474	2000385
40 AGH 120-10D	120	1.00 mm	1,627	2000386
40 AGH 160-10D	160	1.00 mm	1,897	2000387
40 AGH 200-10D	200	1.00 mm	2,159	2000388
40 AGH 300-10D	300	1.00 mm	2,840	2000313

1.20 mm

Sipariş Kodu Order Code	W (mm)	T (mm)	Ağırlık (kg/m) Weight (kg/m)	Barkod Kodu Barcode Code
40 AGH 050-12D	50	1.20 mm	1,335	2000302
40 AGH 100-12D	100	1.20 mm	1,770	2000305
40 AGH 120-12D	120	1.20 mm	1,954	2000389
40 AGH 160-12D	160	1.20 mm	2,277	2000308
40 AGH 200-12D	200	1.20 mm	2,592	2000311
40 AGH 300-12D	300	1.20 mm	3,410	2000314
40 AGH 400-12D	400	1.20 mm	3,527	2000317
40 AGH 500-12D	500	1.20 mm	3,690	2000320

1.50 mm

Sipariş Kodu Order Code	W (mm)	T (mm)	Ağırlık (kg/m) Weight (kg/m)	Barkod Kodu Barcode Code
40 AGH 050-15D	50	1.50 mm	1,673	2000303
40 AGH 100-15D	100	1.50 mm	2,215	2000306
40 AGH 120-15D	120	1.50 mm	2,279	2000390
40 AGH 160-15D	160	1.50 mm	2,852	2000309
40 AGH 200-15D	200	1.50 mm	3,241	2000312
40 AGH 300-15D	300	1.50 mm	4,265	2000315
40 AGH 400-15D	400	1.50 mm	5,291	2000318
40 AGH 500-15D	500	1.50 mm	6,317	2000321
40 AGH 600-15D	600	1.50 mm	7,349	2000322

2.00 mm

Sipariş Kodu Order Code	W (mm)	T (mm)	Ağırlık (kg/m) Weight (kg/m)	Barkod Kodu Barcode Code
40 AGH 050-20D	50	2.00 mm	2,270	2000391
40 AGH 100-20D	100	2.00 mm	3,005	2000392
40 AGH 120-20D	120	2.00 mm	3,092	2000393
40 AGH 160-20D	160	2.00 mm	3,870	2000394
40 AGH 200-20D	200	2.00 mm	4,398	2000395
40 AGH 300-20D	300	2.00 mm	5,686	2000316
40 AGH 400-20D	400	2.00 mm	7,055	2000319
40 AGH 500-20D	500	2.00 mm	8,425	2000408
40 AGH 600-20D	600	2.00 mm	9,788	2000409
40 AGH 700-20D	700	2.00 mm	11,842	2000451
40 AGH 800-20D	800	2.00 mm	13,334	2000452
40 AGH 900-20D	900	2.00 mm	14,825	2000453

40 AGH 100 10D

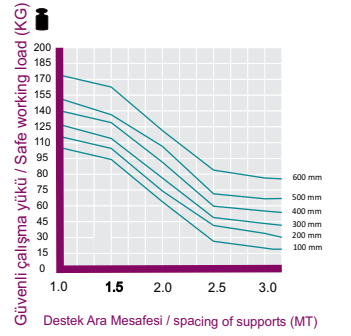

Destek Ara Mesafesi / spacing of supports (MT)

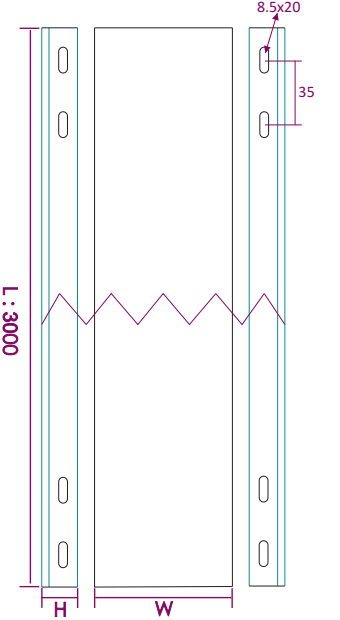

Standart uzunluk L:3000 mm
Toplu miktarlarda Özel ölçüler yapılabilir.
Standard Length L:3000 mm
Custom sizes can be made in bulk quantities.

ARTIM METAL ELEKTRİK A.Ş.

H = YÜKSEKLİK = HEIGHT / W = GENİŞLİK = WIDTH / T = KALINLIK = THICKNESS

* Farklı kalınlık ve ölçülerde üretim yapılabılır.
* Malzeme ağırlıkları yaklaşık değerlerdir, \pm %10 değişiklik gösterebilir.
* Malzeme kalınlık toleransı \pm %10 dur.
* Lütfen siparişlerinizde sipariş kodu veya ürün kodu ve Kaplama şeklini belirtiniz.

* We can produce cable trays different thickness and dimensions
* Cable trays are shown approximately weight, they could change \pm %10 difference.
* Cable trays thickness tolerances are shown \pm %10 .
* Please indicate order code and coating type in your orders.

H40 AGH SERIES

AGIR HIZMET TIP KABLO KANALI (DELIKSIZ)

HEAVY DUTY TYPE CABLE TRAYS (NON PERFORATE)

SICAK DALDIRMA (SD)
HOT DIP GALVANIZED (HDG)
TS EN ISO 1461



0.80 mm

Sipariş Kodu Order Code	W (mm)	T (mm)	Ağırlık (kg/m) Weight (kg/m)	Barkod Kodu Barcode Code
40 AGH 050-08D	50	0.80 mm	1,145	2000301
40 AGH 100-08D	100	0.80 mm	1,273	2000304
40 AGH 120-08D	120	0.80 mm	1,405	2000382
40 AGH 160-08D	160	0.80 mm	1,671	2000383
40 AGH 200-09D	200	0.90 mm	1,900	2000310

1.00 mm

Sipariş Kodu Order Code	W (mm)	T (mm)	Ağırlık (kg/m) Weight (kg/m)	Barkod Kodu Barcode Code
40 AGH 050-10D	50	1.00 mm	1,432	2000384
40 AGH 100-10D	100	1.00 mm	1,592	2000385
40 AGH 120-10D	120	1.00 mm	1,757	2000386
40 AGH 160-10D	160	1.00 mm	2,090	2000387
40 AGH 200-10D	200	1.00 mm	2,375	2000388
40 AGH 300-10D	300	1.00 mm	2,720	2000313

1.20 mm

Sipariş Kodu Order Code	W (mm)	T (mm)	Ağırlık (kg/m) Weight (kg/m)	Barkod Kodu Barcode Code
40 AGH 050-12D	50	1.20 mm	1,719	2000302
40 AGH 100-12D	100	1.20 mm	1,910	2000305
40 AGH 120-12D	120	1.20 mm	2,109	2000389
40 AGH 160-12D	160	1.20 mm	2,508	2000308
40 AGH 200-12D	200	1.20 mm	2,851	2000311
40 AGH 300-12D	300	1.20 mm	3,752	2000314
40 AGH 400-12D	400	1.20 mm	3,882	2000317
40 AGH 500-12D	500	1.20 mm	4,062	2000320

1.50 mm

Sipariş Kodu Order Code	W (mm)	T (mm)	Ağırlık (kg/m) Weight (kg/m)	Barkod Kodu Barcode Code
40 AGH 050-15D	50	1.50 mm	1,733	2000303
40 AGH 100-15D	100	1.50 mm	2,440	2000306
40 AGH 120-15D	120	1.50 mm	2,460	2000390
40 AGH 160-15D	160	1.50 mm	3,138	2000309
40 AGH 200-15D	200	1.50 mm	3,567	2000312
40 AGH 300-15D	300	1.50 mm	4,694	2000315
40 AGH 400-15D	400	1.50 mm	5,821	2000318
40 AGH 500-15D	500	1.50 mm	6,948	2000321
40 AGH 600-15D	600	1.50 mm	8,087	2000322

2.00 mm

Sipariş Kodu Order Code	W (mm)	T (mm)	Ağırlık (kg/m) Weight (kg/m)	Barkod Kodu Barcode Code
40 AGH 050-20D	50	2.00 mm	2,352	2000391
40 AGH 100-20D	100	2.00 mm	3,311	2000392
40 AGH 120-20D	120	2.00 mm	3,338	2000393
40 AGH 160-20D	160	2.00 mm	4,258	2000394
40 AGH 200-20D	200	2.00 mm	4,840	2000395
40 AGH 300-20D	300	2.00 mm	6,255	2000316
40 AGH 400-20D	400	2.00 mm	7,765	2000319
40 AGH 500-20D	500	2.00 mm	9,270	2000408
40 AGH 600-20D	600	2.00 mm	10,769	2000409
40 AGH 700-20D	700	2.00 mm	13,026	2000451
40 AGH 800-20D	800	2.00 mm	14,667	2000452
40 AGH 900-20D	900	2.00 mm	16,308	2000453

H = YÜKSEKLİK = HEIGHT / W = GENİŞLİK = WIDTH / T = KALINLIK = THICKNESS

40 AGH 100 10D

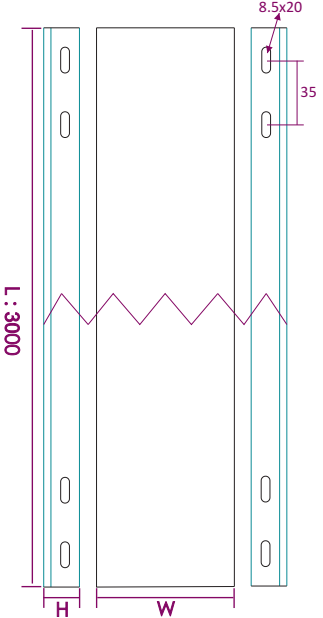
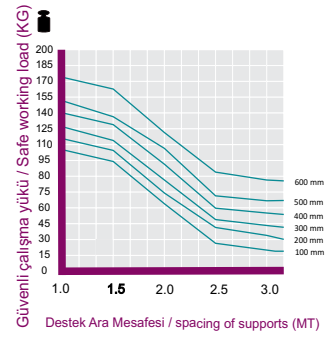
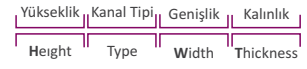

Standart uzunluk L:3000 mm
Toplu miktarlarda Özel ölçüler yapılabilir.
Standard Length L:3000 mm
Custom sizes can be made in bulk quantities.

* Farklı kalınlık ve ölçülerde üretim yapılabılır.
* Malzeme ağırlıkları yaklaşık değerlerdir, \pm %10 değişiklik gösterebilir.
* Malzeme kalınlık toleransı \pm %10 dur.
* Lütfen siparişinizde sipariş kodu veya ürün kodu ve Kaplama şeklini belirtiniz.

* We can produce cable trays different thickness and dimensions
* Cable trays are shown approximately weight, they could change \pm %10 difference.
* Cable trays thickness tolerances are shown \pm %10 .
* Please indicate order code and coating type in your orders.

H40 AST SERIES

STANDART TIP KABLO KANALI

MEDIUM DUTY CABLE TRAYS

SICAK DALDIRMA (SD)
HOT DIP GALVANIZED (HDG)
TS EN ISO 1461

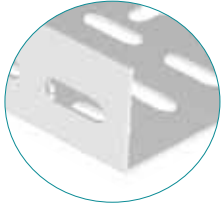

0.80 mm

Sipariş Kodu Order Code	W (mm)	T (mm)	Ağırlık (kg/m) Weight (kg/m)	Barkod Kodu Barcode Code
40 AST 050-08	50	0.80 mm	0,863	2000101
40 AST 100-08	100	0.80 mm	1,003	2000142
40 AST 120-08	120	0.80 mm	1,109	2000143
40 AST 160-08	160	0.80 mm	1,584	2000144
40 AST 200-09	200	0.90 mm	1,724	2000145

1.00 mm

Sipariş Kodu Order Code	W (mm)	T (mm)	Ağırlık (kg/m) Weight (kg/m)	Barkod Kodu Barcode Code
40 AST 050-10	50	1.00 mm	1,078	2000146
40 AST 100-10	100	1.00 mm	1,254	2000104
40 AST 120-10	120	1.00 mm	1,387	2000107
40 AST 160-10	160	1.00 mm	1,980	2000108
40 AST 200-10	200	1.00 mm	1,916	2000110

1.20 mm

Sipariş Kodu Order Code	W (mm)	T (mm)	Ağırlık (kg/m) Weight (kg/m)	Barkod Kodu Barcode Code
40 AST 050-12	50	1.20 mm	1,209	2000102
40 AST 100-12	100	1.20 mm	1,499	2000105
40 AST 120-12	120	1.20 mm	1,664	2000147
40 AST 160-12	160	1.20 mm	2,318	2000109
40 AST 200-12	200	1.20 mm	2,288	2000111
40 AST 300-12	300	1.20 mm	3,087	2000113

1.50 mm

Sipariş Kodu Order Code	W (mm)	T (mm)	Ağırlık (kg/m) Weight (kg/m)	Barkod Kodu Barcode Code
40 AST 050-15	50	1.50 mm	1,617	2000103
40 AST 100-15	100	1.50 mm	1,877	2000106
40 AST 120-15	120	1.50 mm	1,941	2000148
40 AST 160-15	160	1.50 mm	2,704	2000149
40 AST 200-15	200	1.50 mm	2,871	2000112
40 AST 300-15	300	1.50 mm	3,861	2000114
40 AST 400-15	400	1.50 mm	4,846	2000116
40 AST 500-15	500	1.50 mm	5,841	2000118
40 AST 600-15	600	1.50 mm	6,826	2000120

2.00 mm

Sipariş Kodu Order Code	W (mm)	T (mm)	Ağırlık (kg/m) Weight (kg/m)	Barkod Kodu Barcode Code
40 AST 050-20	50	2.00 mm	1,940	2000150
40 AST 100-20	100	2.00 mm	2,547	2000151
40 AST 120-20	120	2.00 mm	2,634	2000152
40 AST 160-20	160	2.00 mm	3,669	2000153
40 AST 200-20	200	2.00 mm	3,896	2000154
40 AST 300-20	300	2.00 mm	5,145	2000115
40 AST 400-20	400	2.00 mm	6,458	2000117
40 AST 500-20	500	2.00 mm	7,786	2000119
40 AST 600-20	600	2.00 mm	9,099	2000121
40 AST 700-20	700	2.00 mm	10,921	2000454
40 AST 800-20	800	2.00 mm	12,332	2000455
40 AST 900-20	900	2.00 mm	13,742	2000456

H = YÜKSEKLİK = HEIGHT / W = GENİŞLİK = WIDTH / T = KALINLIK = THICKNESS

40 AST 100-10

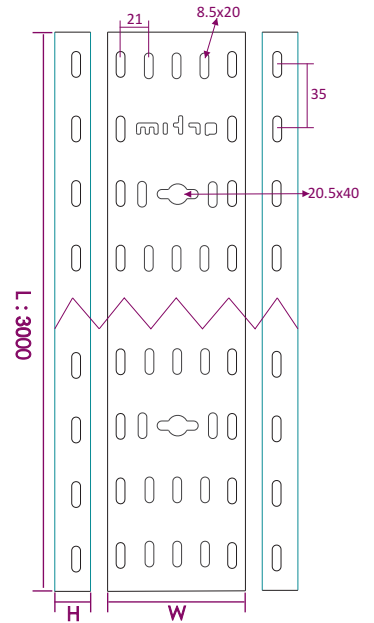
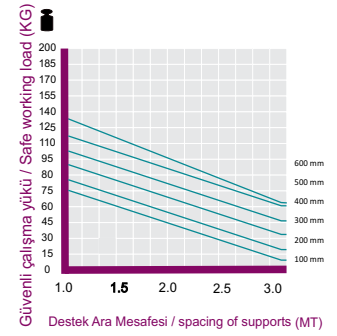

Standart uzunluk L:3000 mm
Toplu miktarlarda Özel ölçüler yapılabilir.
Standard Length L:3000 mm
Custom sizes can be made in bulk quantities.

* Farklı kalınlık ve ölçülerde üretim yapılabılır.
* Malzeme ağırlıkları yaklaşık değerlerdir, \pm %10 değişiklik gösterebilir.
* Malzeme kalınlık toleransı \pm %10 dur.
* Lütfen siparişlerinizde sipariş kodu veya ürün kodu ve Kaplama şeklini belirtiniz.

* We can produce cable trays different thickness and dimensions
* Cable trays are shown approximately weight, they could change \pm %10 difference.
* Cable trays thickness tolerances are shown \pm %10 .
* Please indicate order code and coating type in your orders.

H40 AST SERIES

STANDART TIP KABLO KANALI

MEDIUM DUTY CABLE TRAYS

PREGALVANIZ (PG)
PREGALVANIZED (PG)
TS EN 10346

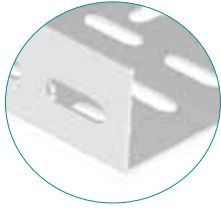

0.80 mm

Sipariş Kodu Order Code	W (mm)	T (mm)	Ağırlık (kg/m) Weight (kg/m)	Barkod Kodu Barcode Code
40 AST 050-08	50	0.80 mm	0,657	2000101
40 AST 100-08	100	0.80 mm	0,910	2000142
40 AST 120-08	120	0.80 mm	1,007	2000143
40 AST 160-08	160	0.80 mm	1,438	2000144
40 AST 200-09	200	0.90 mm	1,566	2000145

1.00 mm

Sipariş Kodu Order Code	W (mm)	T (mm)	Ağırlık (kg/m) Weight (kg/m)	Barkod Kodu Barcode Code
40 AST 050-10	50	1.00 mm	0,821	2000146
40 AST 100-10	100	1.00 mm	1,137	2000104
40 AST 120-10	120	1.00 mm	1,259	2000107
40 AST 160-10	160	1.00 mm	1,561	2000108
40 AST 200-10	200	1.00 mm	1,740	2000110

1.20 mm

Sipariş Kodu Order Code	W (mm)	T (mm)	Ağırlık (kg/m) Weight (kg/m)	Barkod Kodu Barcode Code
40 AST 050-12	50	1.20 mm	1,109	2000102
40 AST 100-12	100	1.20 mm	1,362	2000105
40 AST 120-12	120	1.20 mm	1,511	2000147
40 AST 160-12	160	1.20 mm	1,873	2000109
40 AST 200-12	200	1.20 mm	2,078	2000111
40 AST 300-12	300	1.20 mm	2,803	2000113

1.50 mm

Sipariş Kodu Order Code	W (mm)	T (mm)	Ağırlık (kg/m) Weight (kg/m)	Barkod Kodu Barcode Code
40 AST 050-15	50	1.50 mm	1,230	2000103
40 AST 100-15	100	1.50 mm	1,705	2000106
40 AST 120-15	120	1.50 mm	1,888	2000148
40 AST 160-15	160	1.50 mm	2,342	2000149
40 AST 200-15	200	1.50 mm	2,607	2000112
40 AST 300-15	300	1.50 mm	3,508	2000114
40 AST 400-15	400	1.50 mm	4,405	2000116
40 AST 500-15	500	1.50 mm	5,307	2000118
40 AST 600-15	600	1.50 mm	6,203	2000120

2.00 mm

Sipariş Kodu Order Code	W (mm)	T (mm)	Ağırlık (kg/m) Weight (kg/m)	Barkod Kodu Barcode Code
40 AST 050-20	50	2.00 mm	1,640	2000150
40 AST 100-20	100	2.00 mm	2,273	2000151
40 AST 120-20	120	2.00 mm	2,517	2000152
40 AST 160-20	160	2.00 mm	3,122	2000153
40 AST 200-20	200	2.00 mm	3,476	2000154
40 AST 300-20	300	2.00 mm	4,675	2000115
40 AST 400-20	400	2.00 mm	5,870	2000117
40 AST 500-20	500	2.00 mm	7,076	2000119
40 AST 600-20	600	2.00 mm	8,271	2000121
40 AST 700-20	700	2.00 mm	9,928	2000454
40 AST 800-20	800	2.00 mm	11,211	2000455
40 AST 900-20	900	2.00 mm	12,493	2000456

H = YÜKSEKLİK = HEIGHT / W = GENİŞLİK = WIDTH / T = KALINLIK = THICKNESS

40 AST 100-10

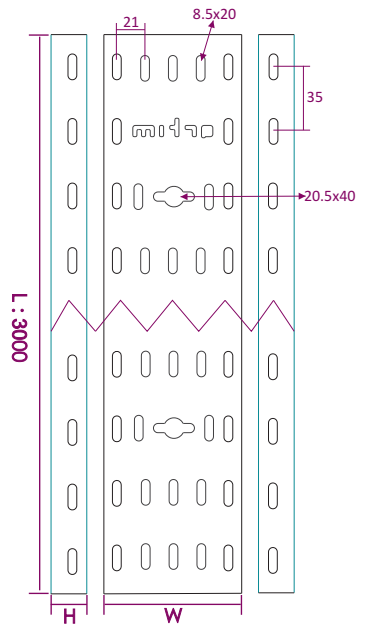
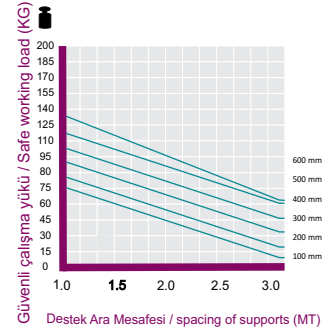

Standart uzunluk L:3000 mm
Toplu miktarlarda Özel ölçüler yapılabilir.
Standard Length L:3000 mm
Custom sizes can be made in bulk quantities.

ARTIM METAL ELEKTRİK A.Ş.

* Farklı kalınlık ve ölçülerde üretim yapılabılır.
* Malzeme ağırlıkları yaklaşık değerlerdir, \pm %10 değişiklik gösterebilir.
* Malzeme kalınlık toleransı \pm %10 dur.
* Lütfen siparişlerinizde sipariş kodu veya ürün kodu ve Kaplama şeklini belirtiniz.

* We can produce cable trays different thickness and dimensions
* Cable trays are shown approximately weight, they could change \pm %10 difference.
* Cable trays thickness tolerances are shown \pm %10 .
* Please indicate order code and coating type in your orders.

H40 AST SERIES

STANDART TIP KABLO KANALI (DELİKSİZ)

MEDIUM DUTY CABLE TRAYS (NON PERFORATED)

PREGALVANİZ (PG)
PREGALVANİZED (PG)
TS EN 10346

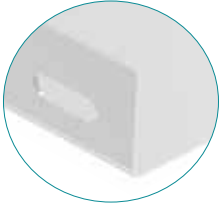

0.80 mm

Sipariş Kodu Order Code	W (mm)	T (mm)	Ağırlık (kg/m) Weight (kg/m)	Barkod Kodu Barcode Code
40 AST 050-08D	50	0.80 mm	0,756	2000101
40 AST 100-08D	100	0.80 mm	1,047	2000142
40 AST 120-08D	120	0.80 mm	1,158	2000143
40 AST 160-08D	160	0.80 mm	1,654	2000144
40 AST 200-09D	200	0.90 mm	1,801	2000145

1.00 mm

Sipariş Kodu Order Code	W (mm)	T (mm)	Ağırlık (kg/m) Weight (kg/m)	Barkod Kodu Barcode Code
40 AST 050-10D	50	1.00 mm	0,944	2000146
40 AST 100-10D	100	1.00 mm	1,308	2000104
40 AST 120-10D	120	1.00 mm	1,448	2000107
40 AST 160-10D	160	1.00 mm	1,795	2000108
40 AST 200-10D	200	1.00 mm	2,001	2000110

1.20 mm

Sipariş Kodu Order Code	W (mm)	T (mm)	Ağırlık (kg/m) Weight (kg/m)	Barkod Kodu Barcode Code
40 AST 050-12D	50	1.20 mm	1,275	2000102
40 AST 100-12D	100	1.20 mm	1,566	2000105
40 AST 120-12D	120	1.20 mm	1,738	2000147
40 AST 160-12D	160	1.20 mm	2,154	2000109
40 AST 200-12D	200	1.20 mm	2,390	2000111
40 AST 300-12D	300	1.20 mm	2,803	2000113

1.50 mm

Sipariş Kodu Order Code	W (mm)	T (mm)	Ağırlık (kg/m) Weight (kg/m)	Barkod Kodu Barcode Code
40 AST 050-15D	50	1.50 mm	1,415	2000103
40 AST 100-15D	100	1.50 mm	1,961	2000106
40 AST 120-15D	120	1.50 mm	2,171	2000148
40 AST 160-15D	160	1.50 mm	2,693	2000149
40 AST 200-15D	200	1.50 mm	2,998	2000112
40 AST 300-15D	300	1.50 mm	4,034	2000114
40 AST 400-15D	400	1.50 mm	5,066	2000116
40 AST 500-15D	500	1.50 mm	6,103	2000118
40 AST 600-15D	600	1.50 mm	7,133	2000120

2.00 mm

Sipariş Kodu Order Code	W (mm)	T (mm)	Ağırlık (kg/m) Weight (kg/m)	Barkod Kodu Barcode Code
40 AST 050-20D	50	2.00 mm	1,886	2000150
40 AST 100-20D	100	2.00 mm	2,614	2000151
40 AST 120-20D	120	2.00 mm	2,895	2000152
40 AST 160-20D	160	2.00 mm	3,590	2000153
40 AST 200-20D	200	2.00 mm	3,997	2000154
40 AST 300-20D	300	2.00 mm	5,376	2000115
40 AST 400-20D	400	2.00 mm	6,751	2000117
40 AST 500-20D	500	2.00 mm	8,137	2000119
40 AST 600-20D	600	2.00 mm	9,512	2000121
40 AST 700-20D	700	2.00 mm	11,544	2000454
40 AST 800-20D	800	2.00 mm	13,036	2000455
40 AST 900-20D	900	2.00 mm	14,527	2000456

H = YÜKSEKLİK = HEIGHT / W = GENİŞLİK = WIDTH / T = KALINLIK = THICKNESS

40 AST 100-10D

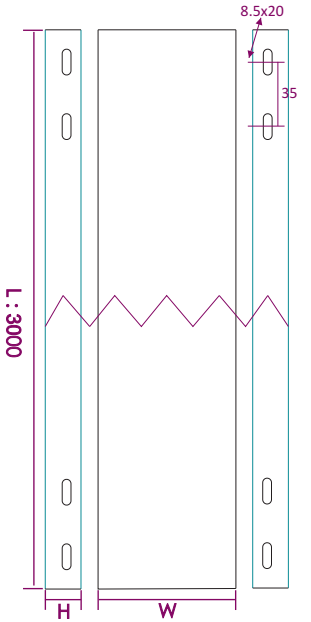
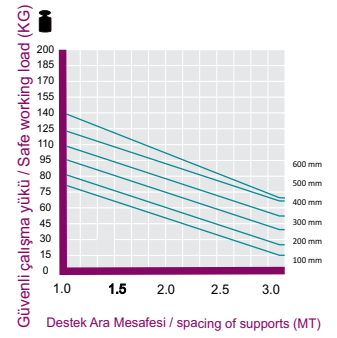

Standart uzunluk L:3000 mm
Toplu miktarlarda Özel ölçüler yapılabilir.
Standard Length L:3000 mm
Custom sizes can be made in bulk quantities.

ARTIM METAL ELEKTRİK A.Ş.

* Farklı kalınlık ve ölçülerde üretim yapılabılır.
* Malzeme ağırlıkları yaklaşık değerlerdir, ± %10 değişiklik gösterebilir.
* Malzeme kalınlık toleransı ± %10 dur.
* Lütfen siparişlerinizde sipariş kodu veya ürün kodu ve Kaplama şeklini belirtiniz.

* We can produce cable trays different thickness and dimensions
* Cable trays are shown approximately weight, they could change ± %10 difference.
* Cable trays thickness tolerances are shown ± %10 .
* Please indicate order code and coating type in your orders.

H40 AST SERIES

STANDART TIP KABLO KANALI (DELİKSİZ)

MEDIUM DUTY CABLE TRAYS (NON PERFORATED)

SICAK DALDIRMA (SD)
HOT DIP GALVANIZED (HDG)
TS EN ISO 1461

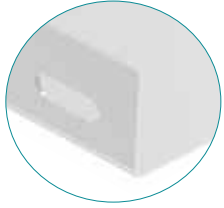

0.80 mm

Sipariş Kodu Order Code	W (mm)	T (mm)	Ağırlık (kg/m) Weight (kg/m)	Barkod Kodu Barcode Code
40 AST 050-08D	50	0.80 mm	0,992	2000101
40 AST 100-08D	100	0.80 mm	1,153	2000142
40 AST 120-08D	120	0.80 mm	1,275	2000143
40 AST 160-08D	160	0.80 mm	1,822	2000144
40 AST 200-09D	200	0.90 mm	1,983	2000145

1.00 mm

Sipariş Kodu Order Code	W (mm)	T (mm)	Ağırlık (kg/m) Weight (kg/m)	Barkod Kodu Barcode Code
40 AST 050-10D	50	1.00 mm	1,240	2000146
40 AST 100-10D	100	1.00 mm	1,442	2000104
40 AST 120-10D	120	1.00 mm	1,595	2000107
40 AST 160-10D	160	1.00 mm	2,277	2000108
40 AST 200-10D	200	1.00 mm	2,203	2000110

1.20 mm

Sipariş Kodu Order Code	W (mm)	T (mm)	Ağırlık (kg/m) Weight (kg/m)	Barkod Kodu Barcode Code
40 AST 050-12D	50	1.20 mm	1,390	2000102
40 AST 100-12D	100	1.20 mm	1,724	2000105
40 AST 120-12D	120	1.20 mm	1,914	2000147
40 AST 160-12D	160	1.20 mm	2,666	2000109
40 AST 200-12D	200	1.20 mm	2,631	2000111
40 AST 300-12D	300	1.20 mm	3,087	2000113

1.50 mm

Sipariş Kodu Order Code	W (mm)	T (mm)	Ağırlık (kg/m) Weight (kg/m)	Barkod Kodu Barcode Code
40 AST 050-15D	50	1.50 mm	1,860	2000103
40 AST 100-15D	100	1.50 mm	2,159	2000106
40 AST 120-15D	120	1.50 mm	2,232	2000148
40 AST 160-15D	160	1.50 mm	3,110	2000149
40 AST 200-15D	200	1.50 mm	3,302	2000112
40 AST 300-15D	300	1.50 mm	4,440	2000114
40 AST 400-15D	400	1.50 mm	5,573	2000116
40 AST 500-15D	500	1.50 mm	6,717	2000118
40 AST 600-15D	600	1.50 mm	7,850	2000120

2.00 mm

Sipariş Kodu Order Code	W (mm)	T (mm)	Ağırlık (kg/m) Weight (kg/m)	Barkod Kodu Barcode Code
40 AST 050-20D	50	2.00 mm	2,231	2000150
40 AST 100-20D	100	2.00 mm	2,929	2000151
40 AST 120-20D	120	2.00 mm	3,029	2000152
40 AST 160-20D	160	2.00 mm	4,219	2000153
40 AST 200-20D	200	2.00 mm	4,480	2000154
40 AST 300-20D	300	2.00 mm	5,917	2000115
40 AST 400-20D	400	2.00 mm	7,427	2000117
40 AST 500-20D	500	2.00 mm	8,954	2000119
40 AST 600-20D	600	2.00 mm	10,464	2000121
40 AST 700-20D	700	2.00 mm	12,698	2000454
40 AST 800-20D	800	2.00 mm	14,340	2000455
40 AST 900-20D	900	2.00 mm	15,980	2000456

H = YÜKSEKLİK = HEIGHT / W = GENİŞLİK = WIDTH / T = KALINLIK = THICKNESS

40 AST 100-10D

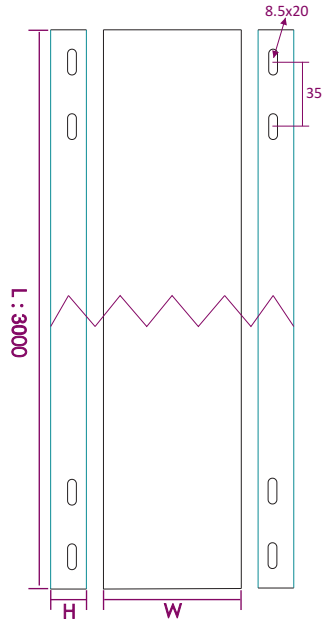
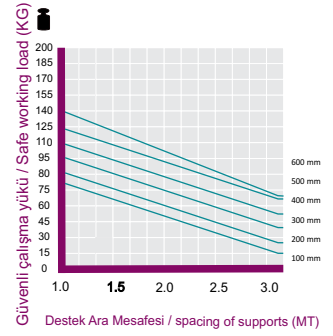

Standart uzunluk L:3000 mm
Toplu miktarlarda Özel ölçüler yapılabilir.
Standard Length L:3000 mm
Custom sizes can be made in bulk quantities.

* Farklı kalınlık ve ölçülerde üretim yapılabılır.
* Malzeme ağırlıkları yaklaşık değerlerdir, \pm %10 değişiklik gösterebilir.
* Malzeme kalınlık toleransı \pm %10 dur.
* Lütfen siparişlerinizde sipariş kodu veya ürün kodu ve Kaplama şeklini belirtiniz.

* We can produce cable trays different thickness and dimensions
* Cable trays are shown approximately weight, they could change \pm %10 difference.
* Cable trays thickness tolerances are shown \pm %10 .
* Please indicate order code and coating type in your orders.

H50 AGH SERIES

AGIR HIZMET TIP KABLO KANALI

HEAVY DUTY TYPE CABLE TRAYS

PREGALVANIZ (PG)
PREGALVANIZED (PG)
TS EN 10346

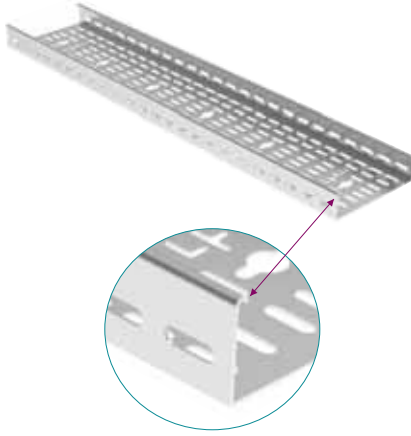

0.80 mm

Sipariş Kodu Order Code	W (mm)	T (mm)	Ağırlık (kg/m) Weight (kg/m)	Barkod Kodu Barcode Code
50 AGH 050-08	50	0.80 mm	0,902	2000323
50 AGH 100-08	100	0.80 mm	1,148	2000395
50 AGH 160-08	160	0.80 mm	1,321	2000397
50 AGH 200-09	200	0.90 mm	1,826	2000398

1.00 mm

Sipariş Kodu Order Code	W (mm)	T (mm)	Ağırlık (kg/m) Weight (kg/m)	Barkod Kodu Barcode Code
50 AGH 050-10	50	1.00 mm	1,127	2000399
50 AGH 100-10	100	1.00 mm	1,436	2000326
50 AGH 160-10	160	1.00 mm	1,651	2000329
50 AGH 200-10	200	1.00 mm	2,029	2000332
50 AGH 300-10	300	1.00 mm	2,626	2000335

1.20 mm

Sipariş Kodu Order Code	W (mm)	T (mm)	Ağırlık (kg/m) Weight (kg/m)	Barkod Kodu Barcode Code
50 AGH 050-12	50	1.20 mm	1,348	2000324
50 AGH 100-12	100	1.20 mm	1,725	2000327
50 AGH 160-12	160	1.20 mm	2,166	2000330
50 AGH 200-12	200	1.20 mm	2,440	2000333
50 AGH 300-12	300	1.20 mm	3,151	2000336
50 AGH 400-12	400	1.20 mm	3,866	2000339
50 AGH 500-12	500	1.20 mm	4,586	2000342

1.50 mm

Sipariş Kodu Order Code	W (mm)	T (mm)	Ağırlık (kg/m) Weight (kg/m)	Barkod Kodu Barcode Code
50 AGH 050-15	50	1.50 mm	1,686	2000325
50 AGH 100-15	100	1.50 mm	2,156	2000328
50 AGH 160-15	160	1.50 mm	2,685	2000331
50 AGH 200-15	200	1.50 mm	3,048	2000334
50 AGH 300-15	300	1.50 mm	3,940	2000337
50 AGH 400-15	400	1.50 mm	4,831	2000340
50 AGH 500-15	500	1.50 mm	5,728	2000343
50 AGH 600-15	600	1.50 mm	6,620	2000345

2.00 mm

Sipariş Kodu Order Code	W (mm)	T (mm)	Ağırlık (kg/m) Weight (kg/m)	Barkod Kodu Barcode Code
50 AGH 050-20	50	2.00 mm	1,806	2000403
50 AGH 100-20	100	2.00 mm	2,926	2000404
50 AGH 160-20	160	2.00 mm	3,643	2000406
50 AGH 200-20	200	2.00 mm	4,136	2000407
50 AGH 300-20	300	2.00 mm	5,253	2000338
50 AGH 400-20	400	2.00 mm	6,444	2000341
50 AGH 500-20	500	2.00 mm	7,634	2000344
50 AGH 600-20	600	2.00 mm	8,820	2000346
50 AGH 700-20	700	2.00 mm	10,441	2000457
50 AGH 800-20	800	2.00 mm	11,723	2000458
50 AGH 900-20	900	2.00 mm	13,006	2000459

H = YÜKSEKLİK = HEIGHT / W = GENİŞLİK = WIDTH / T = KALINLIK = THICKNESS

50 AGH 100 - 10

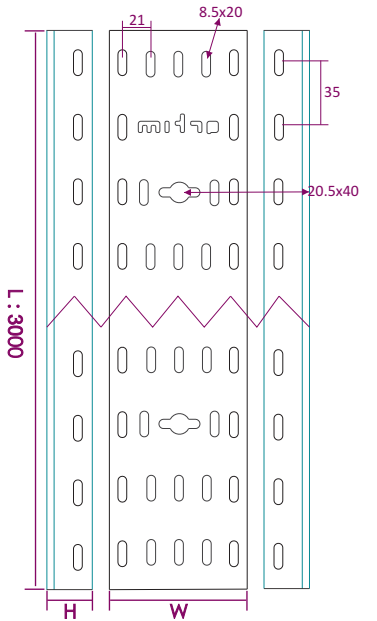
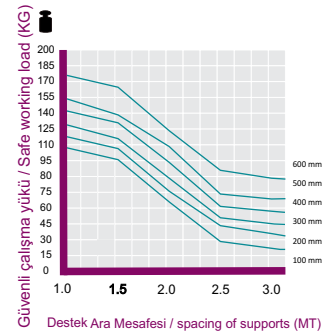

Standart uzunluk L:3000 mm
Toplu miktarlarda Özel ölçüler yapılabilir.
Standard Length L:3000 mm
Custom sizes can be made in bulk quantities.

ARTIM METAL ELEKTRİK A.Ş.

* Farklı kalınlık ve ölçülerde üretim yapılabılır.
* Malzeme ağırlıkları yaklaşık değerlerdir, ± %10 değişiklik gösterebilir.
* Malzeme kalınlık toleransı ± %10 dur.
* Lütfen siparişlerinizde sipariş kodu veya ürün kodu ve Kaplama şeklini belirtiniz.

* We can produce cable trays different thickness and dimensions
* Cable trays are shown approximately weight, they could change ± %10 difference.
* Cable trays thickness tolerances are shown ± %10 .
* Please indicate order code and coating type in your orders.

H50 AGH SERIES

AGIR HIZMET TIP KABLO KANALI

HEAVY DUTY TYPE CABLE TRAYS

SICAK DALDIRMA (SD)
HOT DIP GALVANIZED (SD)
TS EN ISO 1461

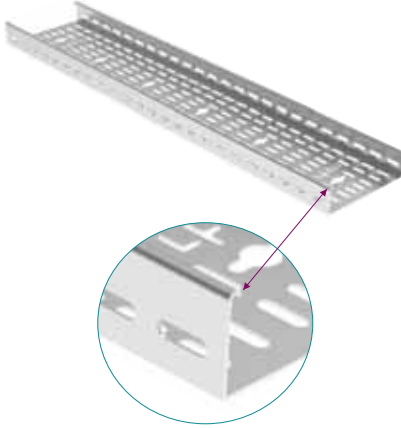

0.80 mm

Sipariş Kodu Order Code	W (mm)	T (mm)	Ağırlık (kg/m) Weight (kg/m)	Barkod Kodu Barcode Code
50 AGH 050-08	50	0.80 mm	0,990	2000323
50 AGH 100-08	100	0.80 mm	1,266	2000395
50 AGH 160-08	160	0.80 mm	1,454	2000397
50 AGH 200-09	200	0.90 mm	1,787	2000398

1.00 mm

Sipariş Kodu Order Code	W (mm)	T (mm)	Ağırlık (kg/m) Weight (kg/m)	Barkod Kodu Barcode Code
50 AGH 050-10	50	1.00 mm	1,237	2000399
50 AGH 100-10	100	1.00 mm	1,583	2000326
50 AGH 160-10	160	1.00 mm	1,818	2000329
50 AGH 200-10	200	1.00 mm	2,234	2000332
50 AGH 300-10	300	1.00 mm	2,891	2000335

1.20 mm

Sipariş Kodu Order Code	W (mm)	T (mm)	Ağırlık (kg/m) Weight (kg/m)	Barkod Kodu Barcode Code
50 AGH 050-12	50	1.20 mm	1,485	2000324
50 AGH 100-12	100	1.20 mm	1,901	2000327
50 AGH 160-12	160	1.20 mm	2,367	2000330
50 AGH 200-12	200	1.20 mm	2,685	2000333
50 AGH 300-12	300	1.20 mm	3,469	2000336
50 AGH 400-12	400	1.20 mm	4,253	2000339
50 AGH 500-12	500	1.20 mm	5,047	2000342

1.50 mm

Sipariş Kodu Order Code	W (mm)	T (mm)	Ağırlık (kg/m) Weight (kg/m)	Barkod Kodu Barcode Code
50 AGH 050-15	50	1.50 mm	1,857	2000325
50 AGH 100-15	100	1.50 mm	2,372	2000328
50 AGH 160-15	160	1.50 mm	3,007	2000331
50 AGH 200-15	200	1.50 mm	3,357	2000334
50 AGH 300-15	300	1.50 mm	4,337	2000337
50 AGH 400-15	400	1.50 mm	5,316	2000340
50 AGH 500-15	500	1.50 mm	6,301	2000343
50 AGH 600-15	600	1.50 mm	7,281	2000345

2.00 mm

Sipariş Kodu Order Code	W (mm)	T (mm)	Ağırlık (kg/m) Weight (kg/m)	Barkod Kodu Barcode Code
50 AGH 050-20	50	2.00 mm	2,520	2000403
50 AGH 100-20	100	2.00 mm	3,219	2000404
50 AGH 160-20	160	2.00 mm	4,080	2000406
50 AGH 200-20	200	2.00 mm	4,555	2000407
50 AGH 300-20	300	2.00 mm	5,782	2000338
50 AGH 400-20	400	2.00 mm	7,088	2000341
50 AGH 500-20	500	2.00 mm	8,399	2000344
50 AGH 600-20	600	2.00 mm	9,702	2000346
50 AGH 700-20	700	2.00 mm	11,485	2000457
50 AGH 800-20	800	2.00 mm	12,895	2000458
50 AGH 900-20	900	2.00 mm	14,307	2000459

H = YÜKSEKLİK = HEIGHT / W = GENİŞLİK = WIDTH / T = KALINLIK = THICKNESS

50 AGH 100 - 10

Yükseklik | Kanal Tipi | Genişlik | Kalınlık
Height | Type | Width | Thickness

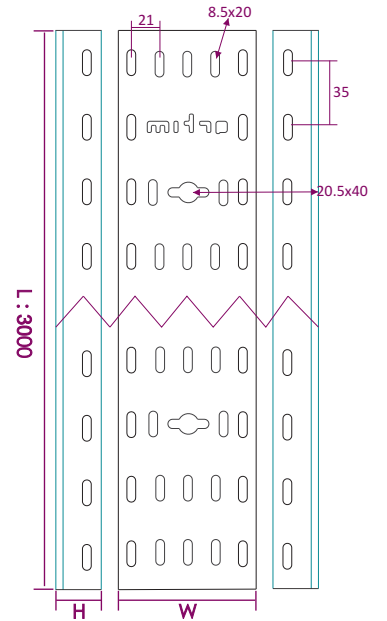
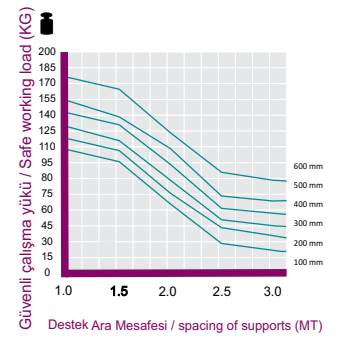

Standart uzunluk L:3000 mm
Toplu miktarlarda Özel ölçüler yapılabilir.
Standard Length L:3000 mm
Custom sizes can be made in bulk quantities.

* Farklı kalınlık ve ölçülerde üretim yapılabılır.
* Malzeme ağırlıkları yaklaşık değerlerdir, ± %10 değişiklik gösterebilir.
* Malzeme kalınlık toleransı ± %10 dur.
* Lütfen siparişlerinizde sipariş kodu veya ürün kodu ve Kaplama şeklini belirtiniz.

* We can produce cable trays different thickness and dimensions
* Cable trays are shown approximately weight, they could change ± %10 difference.
* Cable trays thickness tolerances are shown ± %10 .
* Please indicate order code and coating type in your orders.

H50 AGH SERIES

AGIR HIZMET KABLO KANALI (DELIKSİZ)

HEAVY DUTY TYPE CABLE TRAYS (NON PERFORATED)

PREGALVANIZ (PG)
PREGALVANIZED (PG)
TS EN 10346



0.80 mm

Sipariş Kodu Order Code	W (mm)	T (mm)	Ağırlık (kg/m) Weight (kg/m)	Barkod Kodu Barcode Code
50 AGH 050-08D	50	0.80 mm	1,037	2000323
50 AGH 100-08D	100	0.80 mm	1,320	2000395
50 AGH 160-08D	160	0.80 mm	1,519	2000397
50 AGH 200-09D	200	0.90 mm	2,100	2000398

1.00 mm

Sipariş Kodu Order Code	W (mm)	T (mm)	Ağırlık (kg/m) Weight (kg/m)	Barkod Kodu Barcode Code
50 AGH 050-10D	50	1.00 mm	1,296	2000399
50 AGH 100-10D	100	1.00 mm	1,651	2000326
50 AGH 160-10D	160	1.00 mm	1,899	2000329
50 AGH 200-10D	200	1.00 mm	2,333	2000332
50 AGH 300-10D	300	1.00 mm	3,020	2000335

1.20 mm

Sipariş Kodu Order Code	W (mm)	T (mm)	Ağırlık (kg/m) Weight (kg/m)	Barkod Kodu Barcode Code
50 AGH 050-12D	50	1.20 mm	1,550	2000324
50 AGH 100-12D	100	1.20 mm	1,984	2000327
50 AGH 160-12D	160	1.20 mm	2,491	2000330
50 AGH 200-12D	200	1.20 mm	2,806	2000333
50 AGH 300-12D	300	1.20 mm	3,624	2000336
50 AGH 400-12D	400	1.20 mm	4,446	2000339
50 AGH 500-12D	500	1.20 mm	5,274	2000342

1.50 mm

Sipariş Kodu Order Code	W (mm)	T (mm)	Ağırlık (kg/m) Weight (kg/m)	Barkod Kodu Barcode Code
50 AGH 050-15D	50	1.50 mm	1,939	2000325
50 AGH 100-15D	100	1.50 mm	2,479	2000328
50 AGH 160-15D	160	1.50 mm	3,088	2000331
50 AGH 200-15D	200	1.50 mm	3,505	2000334
50 AGH 300-15D	300	1.50 mm	4,531	2000337
50 AGH 400-15D	400	1.50 mm	5,556	2000340
50 AGH 500-15D	500	1.50 mm	6,587	2000343
50 AGH 600-15D	600	1.50 mm	7,613	2000345

2.00 mm

Sipariş Kodu Order Code	W (mm)	T (mm)	Ağırlık (kg/m) Weight (kg/m)	Barkod Kodu Barcode Code
50 AGH 050-20D	50	2.00 mm	2,077	2000403
50 AGH 100-20D	100	2.00 mm	3,365	2000404
50 AGH 160-20D	160	2.00 mm	4,189	2000406
50 AGH 200-20D	200	2.00 mm	4,756	2000407
50 AGH 300-20D	300	2.00 mm	6,041	2000338
50 AGH 400-20D	400	2.00 mm	7,411	2000341
50 AGH 500-20D	500	2.00 mm	8,779	2000344
50 AGH 600-20D	600	2.00 mm	10,143	2000346
50 AGH 700-20D	700	2.00 mm	12,141	2000457
50 AGH 800-20D	800	2.00 mm	13,632	2000458
50 AGH 900-20D	900	2.00 mm	15,124	2000459

H = YÜKSEKLİK = HEIGHT / W = GENİŞLİK = WIDTH / T = KALINLIK = THICKNESS

50 AGH 100 10D

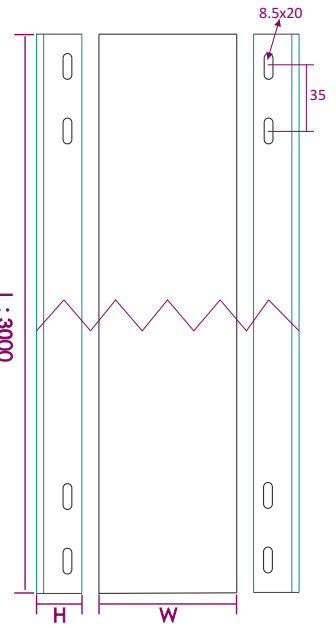
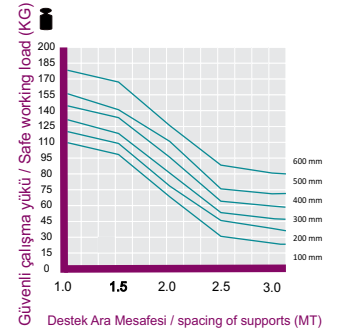

Standart uzunluk L:3000 mm
Toplu miktarlarda Özel ölçüler yapılabilir.
Standard Length L:3000 mm
Custom sizes can be made in bulk quantities.

ARTIM METAL ELEKTRİK A.Ş.

* Farklı kalınlık ve ölçülerde üretim yapılabılır.
* Malzeme ağırlıkları yaklaşık değerlerdir, ± %10 değişiklik gösterebilir.
* Malzeme kalınlık toleransı ± %10 dur.
* Lütfen siparişlerinizde sipariş kodu veya ürün kodu ve Kaplama şeklini belirtiniz.

* We can produce cable trays different thickness and dimensions
* Cable trays are shown approximately weight, they could change ± %10 difference.
* Cable trays thickness tolerances are shown ± %10 .
* Please indicate order code and coating type in your orders.

H50 AGH SERIES

AGIR HIZMET KABLO KANALI (DELIKSİZ)

HEAVY DUTY TYPE CABLE TRAYS (NON PERFORATED)

SICAK DALDIRMA (SD)
HOT DIP GALVANIZED (SD)
TS EN ISO 1461

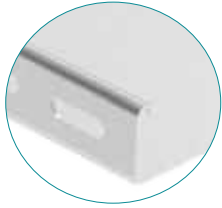

0.80 mm

Sipariş Kodu Order Code	W (mm)	T (mm)	Ağırlık (kg/m) Weight (kg/m)	Barkod Kodu Barcode Code
50 AGH 050-08D	50	0.80 mm	1,139	2000323
50 AGH 100-08D	100	0.80 mm	1,456	2000395
50 AGH 160-08D	160	0.80 mm	1,672	2000397
50 AGH 200-09D	200	0.90 mm	2,055	2000398

1.00 mm

Sipariş Kodu Order Code	W (mm)	T (mm)	Ağırlık (kg/m) Weight (kg/m)	Barkod Kodu Barcode Code
50 AGH 050-10D	50	1.00 mm	1,423	2000399
50 AGH 100-10D	100	1.00 mm	1,820	2000326
50 AGH 160-10D	160	1.00 mm	2,091	2000329
50 AGH 200-10D	200	1.00 mm	2,569	2000332
50 AGH 300-10D	300	1.00 mm	3,325	2000335

1.20 mm

Sipariş Kodu Order Code	W (mm)	T (mm)	Ağırlık (kg/m) Weight (kg/m)	Barkod Kodu Barcode Code
50 AGH 050-12D	50	1.20 mm	1,708	2000324
50 AGH 100-12D	100	1.20 mm	2,186	2000327
50 AGH 160-12D	160	1.20 mm	2,722	2000330
50 AGH 200-12D	200	1.20 mm	3,088	2000333
50 AGH 300-12D	300	1.20 mm	3,989	2000336
50 AGH 400-12D	400	1.20 mm	4,891	2000339
50 AGH 500-12D	500	1.20 mm	5,804	2000342

1.50 mm

Sipariş Kodu Order Code	W (mm)	T (mm)	Ağırlık (kg/m) Weight (kg/m)	Barkod Kodu Barcode Code
50 AGH 050-15D	50	1.50 mm	2,136	2000325
50 AGH 100-15D	100	1.50 mm	2,728	2000328
50 AGH 160-15D	160	1.50 mm	3,458	2000331
50 AGH 200-15D	200	1.50 mm	3,861	2000334
50 AGH 300-15D	300	1.50 mm	4,988	2000337
50 AGH 400-15D	400	1.50 mm	6,113	2000340
50 AGH 500-15D	500	1.50 mm	7,246	2000343
50 AGH 600-15D	600	1.50 mm	8,373	2000345

2.00 mm

Sipariş Kodu Order Code	W (mm)	T (mm)	Ağırlık (kg/m) Weight (kg/m)	Barkod Kodu Barcode Code
50 AGH 050-20D	50	2.00 mm	2,898	2000403
50 AGH 100-20D	100	2.00 mm	3,702	2000404
50 AGH 160-20D	160	2.00 mm	4,692	2000406
50 AGH 200-20D	200	2.00 mm	5,238	2000407
50 AGH 300-20D	300	2.00 mm	6,649	2000338
50 AGH 400-20D	400	2.00 mm	8,151	2000341
50 AGH 500-20D	500	2.00 mm	9,659	2000344
50 AGH 600-20D	600	2.00 mm	11,157	2000346
50 AGH 700-20D	700	2.00 mm	13,355	2000457
50 AGH 800-20D	800	2.00 mm	14,995	2000458
50 AGH 900-20D	900	2.00 mm	16,636	2000459

H = YÜKSEKLİK = HEIGHT / W = GENİŞLİK = WIDTH / T = KALINLIK = THICKNESS

50 AGH 100 10D

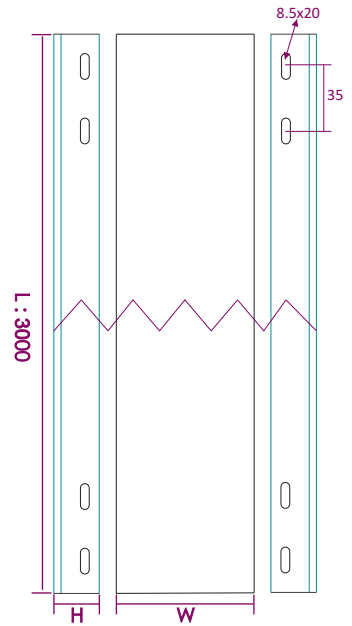
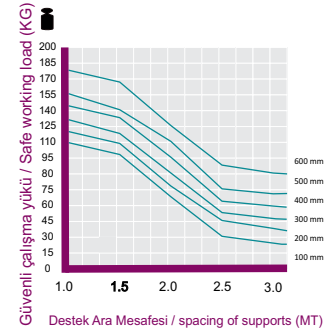

Standart uzunluk L:3000 mm
Toplu miktarlarda Özel ölçüler yapılabilir.
Standard Length L:3000 mm
Custom sizes can be made in bulk quantities.

* Farklı kalınlık ve ölçülerde üretim yapıla bilinir.
* Malzeme ağırlıkları yaklaşık değerlerdir, \pm %10 değişiklik gösterebilir.
* Malzeme kalınlık toleransı \pm %10 dur.
* Lütfen siparişlerinizde sipariş kodu veya ürün kodu ve Kaplama şeklini belirtiniz.

* We can produce cable trays different thickness and dimensions
* Cable trays are shown approximately weight, they could change \pm %10 difference.
* Cable trays thickness tolerances are shown \pm %10 .
* Please indicate order code and coating type in your orders.

H50 AST SERIES

STANDART TIP KABLO KANALLARI

MEDIUM DUTY CABLE TRAYS

PREGALVANIZ (PG)
PREGALVANIZED (PG)
TS EN 10346

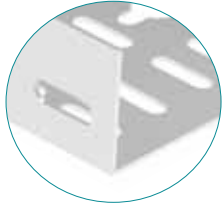

0.80 mm

Sipariş Kodu Order Code	W (mm)	T (mm)	Ağırlık (kg/m) Weight (kg/m)	Barkod Kodu Barcode Code
50 AST 050-08	50	0.80 mm	0,779	2000122
50 AST 100-08	100	0.80 mm	1,035	2000155
50 AST 160-08	160	0.80 mm	1,403	2000157
50 AST 200-09	200	0.90 mm	1,701	2000158

1.00 mm

Sipariş Kodu Order Code	W (mm)	T (mm)	Ağırlık (kg/m) Weight (kg/m)	Barkod Kodu Barcode Code
50 AST 050-10	50	1.00 mm	0,975	2000159
50 AST 100-10	100	1.00 mm	1,294	2000124
50 AST 160-10	160	1.00 mm	1,754	2000128
50 AST 200-10	200	1.00 mm	1,891	2000130

1.20 mm

Sipariş Kodu Order Code	W (mm)	T (mm)	Ağırlık (kg/m) Weight (kg/m)	Barkod Kodu Barcode Code
50 AST 050-12	50	1.20 mm	1,171	2000123
50 AST 100-12	100	1.20 mm	1,548	2000126
50 AST 160-12	160	1.20 mm	2,105	2000129
50 AST 200-12	200	1.20 mm	2,269	2000131
50 AST 300-12	300	1.20 mm	2,989	2000133

1.50 mm

Sipariş Kodu Order Code	W (mm)	T (mm)	Ağırlık (kg/m) Weight (kg/m)	Barkod Kodu Barcode Code
50 AST 050-15	50	1.50 mm	1,460	2000124
50 AST 100-15	100	1.50 mm	1,936	2000127
50 AST 160-15	160	1.50 mm	2,456	2000163
50 AST 200-15	200	1.50 mm	2,837	2000132
50 AST 300-15	300	1.50 mm	3,739	2000134
50 AST 400-15	400	1.50 mm	4,635	2000136
50 AST 500-15	500	1.50 mm	5,537	2000138
50 AST 600-15	600	1.50 mm	6,434	2000140
50 AST 600-15	600	1.50 mm	6,434	2000140

2.00 mm

Sipariş Kodu Order Code	W (mm)	T (mm)	Ağırlık (kg/m) Weight (kg/m)	Barkod Kodu Barcode Code
50 AST 050-20	50	2.00 mm	1,981	2000164
50 AST 100-20	100	2.00 mm	2,627	2000165
50 AST 160-20	160	2.00 mm	3,333	2000166
50 AST 200-20	200	2.00 mm	3,850	2000167
50 AST 300-20	300	2.00 mm	4,983	2000135
50 AST 400-20	400	2.00 mm	6,184	2000137
50 AST 500-20	500	2.00 mm	7,384	2000139
50 AST 600-20	600	2.00 mm	8,580	2000141
50 AST 700-20	700	2.00 mm	10,066	2000460
50 AST 800-20	800	2.00 mm	11,334	2000461
50 AST 900-20	900	2.00 mm	12,601	2000462

H = YÜKSEKLİK = HEIGHT / W = GENİŞLİK = WIDTH / T = KALINLIK = THICKNESS

50 AST 100-10

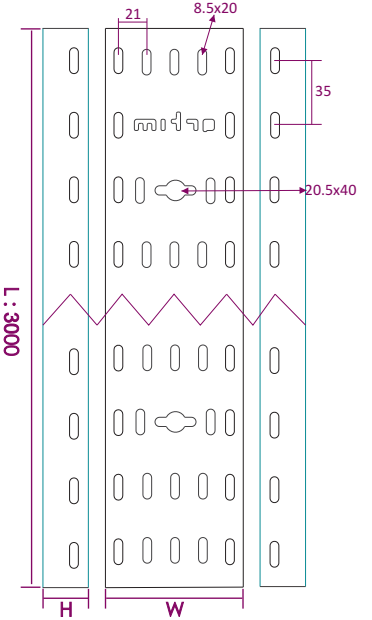
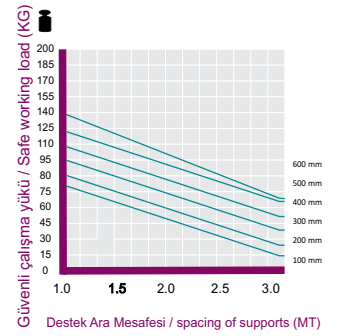

Standart uzunluk L:3000 mm
Toplu miktarlarda Özel ölçüler yapılabilir.
Standard Length L:3000 mm
Custom sizes can be made in bulk quantities.

ARTIM METAL ELEKTRİK A.Ş.

* Farklı kalınlık ve ölçülerde üretim yapılabılır.
* Malzeme ağırlıkları yaklaşık değerlerdir, ± %10 değişiklik gösterebilir.
* Malzeme kalınlık toleransı ± %10 dur.
* Lütfen siparişlerinizde sipariş kodu veya ürün kodu ve Kaplama şeklini belirtiniz.

* We can produce cable trays different thickness and dimensions
* Cable trays are shown approximately weight, they could change ± %10 difference.
* Cable trays thickness tolerances are shown ± %10 .
* Please indicate order code and coating type in your orders.

H50 AST SERIES

STANDART TIP KABLO KANALLARI

MEDIUM DUTY CABLE TRAYS

SICAK DALDIRMA (SD)
HOT DIP GALVANIZED (SD)
TS EN ISO 1461

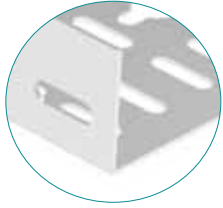

0.80 mm

Sipariş Kodu Order Code	W (mm)	T (mm)	Ağırlık (kg/m) Weight (kg/m)	Barkod Kodu Barcode Code
50 AST 050-08	50	0.80 mm	0,858	2000122
50 AST 100-08	100	0.80 mm	1,136	2000155
50 AST 160-08	160	0.80 mm	1,404	2000157
50 AST 200-09	200	0.90 mm	1,875	2000158

1.00 mm

Sipariş Kodu Order Code	W (mm)	T (mm)	Ağırlık (kg/m) Weight (kg/m)	Barkod Kodu Barcode Code
50 AST 050-10	50	1.00 mm	1,072	2000159
50 AST 100-10	100	1.00 mm	1,421	2000124
50 AST 160-10	160	1.00 mm	1,755	2000128
50 AST 200-10	200	1.00 mm	2,083	2000130

1.20 mm

Sipariş Kodu Order Code	W (mm)	T (mm)	Ağırlık (kg/m) Weight (kg/m)	Barkod Kodu Barcode Code
50 AST 050-12	50	1.20 mm	1,289	2000123
50 AST 100-12	100	1.20 mm	1,705	2000126
50 AST 160-12	160	1.20 mm	2,105	2000129
50 AST 200-12	200	1.20 mm	2,499	2000131
50 AST 300-12	300	1.20 mm	3,288	2000133

1.50 mm

Sipariş Kodu Order Code	W (mm)	T (mm)	Ağırlık (kg/m) Weight (kg/m)	Barkod Kodu Barcode Code
50 AST 050-15	50	1.50 mm	1,607	2000124
50 AST 100-15	100	1.50 mm	2,132	2000127
50 AST 160-15	160	1.50 mm	2,455	2000163
50 AST 200-15	200	1.50 mm	3,121	2000132
50 AST 300-15	300	1.50 mm	4,111	2000134
50 AST 400-15	400	1.50 mm	5,101	2000136
50 AST 500-15	500	1.50 mm	6,091	2000138
50 AST 600-15	600	1.50 mm	7,081	2000140
50 AST 600-15	600	1.50 mm	7,081	2000140

2.00 mm

Sipariş Kodu Order Code	W (mm)	T (mm)	Ağırlık (kg/m) Weight (kg/m)	Barkod Kodu Barcode Code
50 AST 050-20	50	2.00 mm	2,180	2000164
50 AST 100-20	100	2.00 mm	2,893	2000165
50 AST 160-20	160	2.00 mm	3,331	2000166
50 AST 200-20	200	2.00 mm	4,236	2000167
50 AST 300-20	300	2.00 mm	5,483	2000135
50 AST 400-20	400	2.00 mm	6,806	2000137
50 AST 500-20	500	2.00 mm	8,124	2000139
50 AST 600-20	600	2.00 mm	9,437	2000141
50 AST 700-20	700	2.00 mm	11,073	2000460
50 AST 800-20	800	2.00 mm	12,467	2000461
50 AST 900-20	900	2.00 mm	13,861	2000462

H = YÜKSEKLİK = HEIGHT / W = GENİŞLİK = WIDTH / T = KALINLIK = THICKNESS

50 AST 100-10

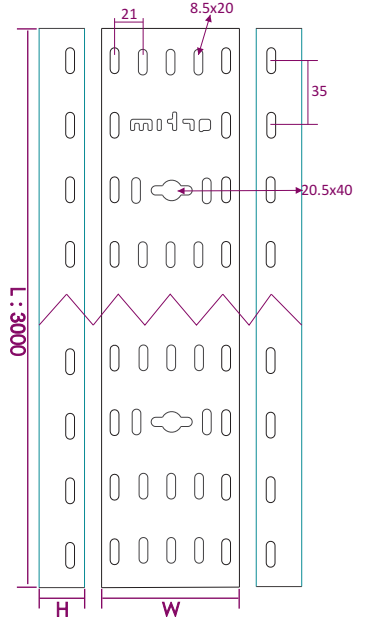
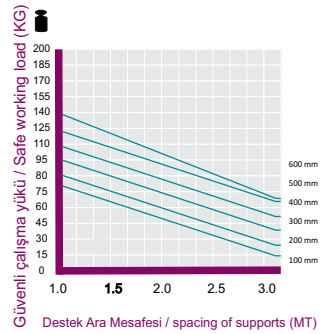

Standart uzunluk L:3000 mm
Toplu miktarlarda Özel ölçüler yapılabilir.
Standard Length L:3000 mm
Custom sizes can be made in bulk quantities.

* Farklı kalınlık ve ölçülerde üretim yapılabılır.
* Malzeme ağırlıkları yaklaşık değerlerdir, ± %10 değişiklik gösterebilir.
* Malzeme kalınlık toleransı ± %10 dur.
* Lütfen siparişlerinizde sipariş kodu veya ürün kodu ve Kaplama şeklini belirtiniz.

* We can produce cable trays different thickness and dimensions
* Cable trays are shown approximately weight, they could change ± %10 difference.
* Cable trays thickness tolerances are shown ± %10 .
* Please indicate order code and coating type in your orders.

H50 AST SERIES

STANDART TİP KABLO KANALLARI (DELİKSİZ)

MEDIUM DUTY CABLE TRAYS (NON PERFORATED)

PREGALVANİZ (PG)
PREGALVANIZED (PG)
TS EN 10346

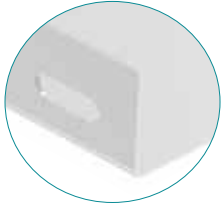

0.80 mm

Sipariş Kodu Order Code	W (mm)	T (mm)	Ağırlık (kg/m) Weight (kg/m)	Barkod Kodu Barcode Code
50 AST 050-08D	50	0.80 mm	0,896	2000122
50 AST 100-08D	100	0.80 mm	1,190	2000155
50 AST 160-08D	160	0.80 mm	1,613	2000157
50 AST 200-09D	200	0.90 mm	1,956	2000158

1.00 mm

Sipariş Kodu Order Code	W (mm)	T (mm)	Ağırlık (kg/m) Weight (kg/m)	Barkod Kodu Barcode Code
50 AST 050-10D	50	1.00 mm	1,121	2000159
50 AST 100-10D	100	1.00 mm	1,488	2000124
50 AST 160-10D	160	1.00 mm	2,017	2000128
50 AST 200-10D	200	1.00 mm	2,175	2000130

1.20 mm

Sipariş Kodu Order Code	W (mm)	T (mm)	Ağırlık (kg/m) Weight (kg/m)	Barkod Kodu Barcode Code
50 AST 050-12D	50	1.20 mm	1,347	2000123
50 AST 100-12D	100	1.20 mm	1,780	2000126
50 AST 160-12D	160	1.20 mm	2,421	2000129
50 AST 200-12D	200	1.20 mm	2,609	2000131
50 AST 300-12D	300	1.20 mm	3,437	2000133

1.50 mm

Sipariş Kodu Order Code	W (mm)	T (mm)	Ağırlık (kg/m) Weight (kg/m)	Barkod Kodu Barcode Code
50 AST 050-15D	50	1.50 mm	1,679	2000124
50 AST 100-15D	100	1.50 mm	2,226	2000127
50 AST 160-15D	160	1.50 mm	2,824	2000163
50 AST 200-15D	200	1.50 mm	3,263	2000132
50 AST 300-15D	300	1.50 mm	4,300	2000134
50 AST 400-15D	400	1.50 mm	5,330	2000136
50 AST 500-15D	500	1.50 mm	6,368	2000138
50 AST 600-15D	600	1.50 mm	7,399	2000140
50 AST 600-15D	600	1.50 mm	7,399	2000140

2.00 mm

Sipariş Kodu Order Code	W (mm)	T (mm)	Ağırlık (kg/m) Weight (kg/m)	Barkod Kodu Barcode Code
50 AST 050-20D	50	2.00 mm	2,278	2000164
50 AST 100-20D	100	2.00 mm	3,021	2000165
50 AST 160-20D	160	2.00 mm	3,833	2000166
50 AST 200-20D	200	2.00 mm	4,428	2000167
50 AST 300-20D	300	2.00 mm	5,730	2000135
50 AST 400-20D	400	2.00 mm	7,112	2000137
50 AST 500-20D	500	2.00 mm	8,492	2000139
50 AST 600-20D	600	2.00 mm	9,867	2000141
50 AST 700-20D	700	2.00 mm	11,842	2000460
50 AST 800-20D	800	2.00 mm	13,334	2000461
50 AST 900-20D	900	2.00 mm	14,825	2000462

H = YÜKSEKLİK = HEIGHT / W = GENİŞLİK = WIDTH / T = KALINLIK = THICKNESS

50 AST 100-10D

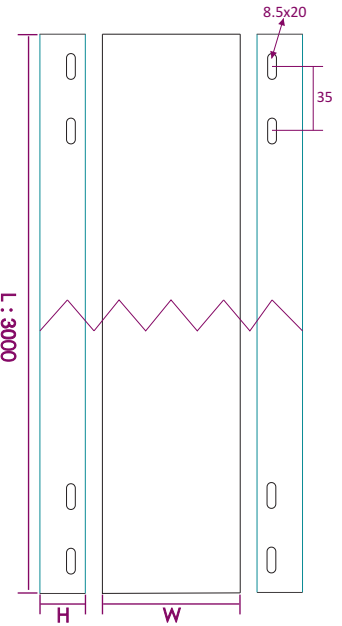
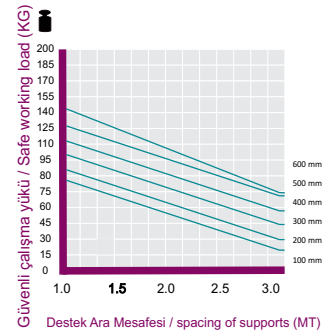

Standart uzunluk L:3000 mm
Toplu miktarlarda Özel ölçüler yapılabilir.
Standard Length L:3000 mm
Custom sizes can be made in bulk quantities.

ARTIM METAL ELEKTRİK A.Ş.

* Farklı kalınlık ve ölçülerde üretim yapılabılır.
* Malzeme ağırlıkları yaklaşık değerlerdir, \pm %10 değişiklik gösterebilir.
* Malzeme kalınlık toleransı \pm %10 dur.
* Lütfen siparişlerinizde sipariş kodu veya ürün kodu ve Kaplama şeklini belirtiniz.

* We can produce cable trays different thickness and dimensions
* Cable trays are shown approximately weight, they could change \pm %10 difference.
* Cable trays thickness tolerances are shown \pm %10 .
* Please indicate order code and coating type in your orders.

H50 AST SERIES

STANDART TIP KABLO KANALLARI (DELİKSİZ)

MEDIUM DUTY CABLE TRAYS (NON PERFORATED)

SICAK DALDIRMA (SD)

HOT DIP GALVANIZED (SD)

TS EN ISO 1461

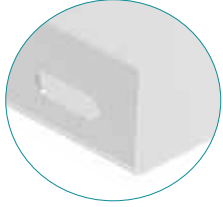

0.80 mm

Sipariş Kodu Order Code	W (mm)	T (mm)	Ağırlık (kg/m) Weight (kg/m)	Barkod Kodu Barcode Code
50 AST 050-08D	50	0.80 mm	0,987	2000122
50 AST 100-08D	100	0.80 mm	1,306	2000155
50 AST 160-08D	160	0.80 mm	1,615	2000157
50 AST 200-09D	200	0.90 mm	2,156	2000158

1.00 mm

Sipariş Kodu Order Code	W (mm)	T (mm)	Ağırlık (kg/m) Weight (kg/m)	Barkod Kodu Barcode Code
50 AST 050-10D	50	1.00 mm	1,233	2000159
50 AST 100-10D	100	1.00 mm	1,634	2000124
50 AST 160-10D	160	1.00 mm	2,018	2000128
50 AST 200-10D	200	1.00 mm	2,395	2000130

1.20 mm

Sipariş Kodu Order Code	W (mm)	T (mm)	Ağırlık (kg/m) Weight (kg/m)	Barkod Kodu Barcode Code
50 AST 050-12D	50	1.20 mm	1,482	2000123
50 AST 100-12D	100	1.20 mm	1,961	2000126
50 AST 160-12D	160	1.20 mm	2,421	2000129
50 AST 200-12D	200	1.20 mm	2,874	2000131
50 AST 300-12D	300	1.20 mm	3,781	2000133

1.50 mm

Sipariş Kodu Order Code	W (mm)	T (mm)	Ağırlık (kg/m) Weight (kg/m)	Barkod Kodu Barcode Code
50 AST 050-15D	50	1.50 mm	1,848	2000124
50 AST 100-15D	100	1.50 mm	2,452	2000127
50 AST 160-15D	160	1.50 mm	2,823	2000163
50 AST 200-15D	200	1.50 mm	3,589	2000132
50 AST 300-15D	300	1.50 mm	4,728	2000134
50 AST 400-15D	400	1.50 mm	5,866	2000136
50 AST 500-15D	500	1.50 mm	7,005	2000138
50 AST 600-15D	600	1.50 mm	8,143	2000140
50 AST 600-15D	600	1.50 mm	8,143	2000140

2.00 mm

Sipariş Kodu Order Code	W (mm)	T (mm)	Ağırlık (kg/m) Weight (kg/m)	Barkod Kodu Barcode Code
50 AST 050-20D	50	2.00 mm	2,507	2000164
50 AST 100-20D	100	2.00 mm	3,327	2000165
50 AST 160-20D	160	2.00 mm	3,831	2000166
50 AST 200-20D	200	2.00 mm	4,871	2000167
50 AST 300-20D	300	2.00 mm	6,305	2000135
50 AST 400-20D	400	2.00 mm	7,827	2000137
50 AST 500-20D	500	2.00 mm	9,343	2000139
50 AST 600-20D	600	2.00 mm	10,853	2000141
50 AST 700-20D	700	2.00 mm	13,026	2000460
50 AST 800-20D	800	2.00 mm	14,667	2000461
50 AST 900-20D	900	2.00 mm	16,308	2000462

H = YÜKSEKLİK = HEIGHT / W = GENİŞLİK = WIDTH / T = KALINLIK = THICKNESS

50 AST 100-10D

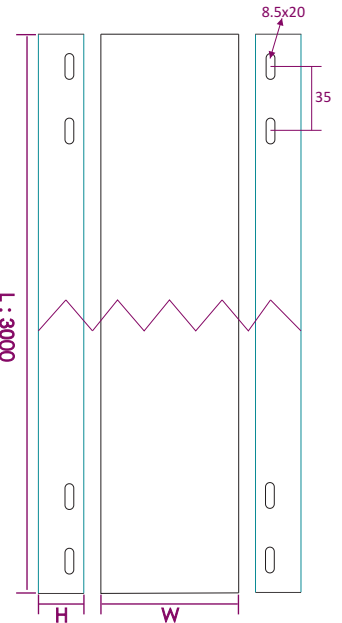
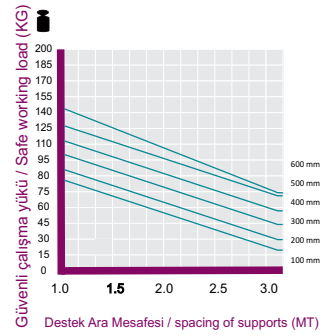

Standart uzunluk L:3000 mm
Toplu miktarlarda Özel ölçüler yapılabilir.
Standard Length L:3000 mm
Custom sizes can be made in bulk quantities.

* Farklı kalınlık ve ölçülerde üretim yapıla bilinir.
* Malzeme ağırlıkları yaklaşık değerlerdir, ± %10 değişiklik gösterebilir.
* Malzeme kalınlık toleransı ± %10 dur.
* Lütfen siparişlerinizde sipariş kodu veya ürün kodu ve Kaplama şeklini belirtiniz.

* We can produce cable trays different thickness and dimensions
* Cable trays are shown approximately weight, they could change ± %10 difference.
* Cable trays thickness tolerances are shown ± %10 .
* Please indicate order code and coating type in your orders.

H60 AGH SERIES

AGIR HIZMET TIP KABLO KANALI

HEAVY DUTY TYPE CABLE TRAYS

PREGALVANIZ (PG)
PREGALVANIZED (PG)
TS EN 10346

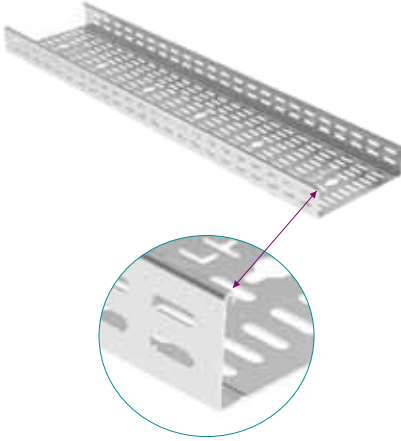

Sipariş Kodu Order Code	W (mm)	T (mm)	Ağırlık (kg/m) Weight (kg/m)	Barkod Kodu Barcode Code
60 AGH 100-08	100	0.80 mm	1,223	2000410
60 AGH 160-08	160	0.80 mm	1,488	2000412
60 AGH 200-09	200	0.90 mm	1,922	2000413

Sipariş Kodu Order Code	W (mm)	T (mm)	Ağırlık (kg/m) Weight (kg/m)	Barkod Kodu Barcode Code
60 AGH 100-10	100	1.00 mm	1,529	2000347
60 AGH 160-10	160	1.00 mm	1,861	2000350
60 AGH 200-10	200	1.00 mm	2,136	2000353
60 AGH 300-10	300	1.00 mm	2,734	2000356

Sipariş Kodu Order Code	W (mm)	T (mm)	Ağırlık (kg/m) Weight (kg/m)	Barkod Kodu Barcode Code
60 AGH 100-12	100	1.20 mm	1,838	2000348
60 AGH 160-12	160	1.20 mm	2,269	2000351
60 AGH 200-12	200	1.20 mm	2,558	2000354
60 AGH 300-12	300	1.20 mm	3,278	2000357
60 AGH 400-12	400	1.20 mm	3,998	2000360
60 AGH 500-12	500	1.20 mm	4,719	2000363

Sipariş Kodu Order Code	W (mm)	T (mm)	Ağırlık (kg/m) Weight (kg/m)	Barkod Kodu Barcode Code
60 AGH 100-15	100	1.50 mm	2,298	2000349
60 AGH 160-15	160	1.50 mm	2,837	2000352
60 AGH 200-15	200	1.50 mm	3,200	2000355
60 AGH 300-15	300	1.50 mm	4,096	2000358
60 AGH 400-15	400	1.50 mm	4,998	2000361
60 AGH 500-15	500	1.50 mm	5,895	2000364
60 AGH 600-15	600	1.50 mm	6,796	2000366

Sipariş Kodu Order Code	W (mm)	T (mm)	Ağırlık (kg/m) Weight (kg/m)	Barkod Kodu Barcode Code
60 AGH 100-20	100	2.00 mm	3,118	2000417
60 AGH 160-20	160	2.00 mm	3,850	2000419
60 AGH 200-20	200	2.00 mm	4,342	2000420
60 AGH 300-20	300	2.00 mm	5,468	2000359
60 AGH 400-20	400	2.00 mm	6,640	2000362
60 AGH 500-20	500	2.00 mm	7,865	2000365
60 AGH 600-20	600	2.00 mm	9,060	2000367
60 AGH 700-20	700	2.00 mm	11,631	2000463
60 AGH 800-20	800	2.00 mm	13,025	2000464
60 AGH 900-20	900	2.00 mm	14,419	2000465

H = YÜKSEKLİK = HEIGHT / W = GENİŞLİK = WIDTH / T = KALINLIK = THICKNESS

0.80 mm

1.00 mm

1.20 mm

1.50 mm

2.00 mm

60 AGH 100 - 10

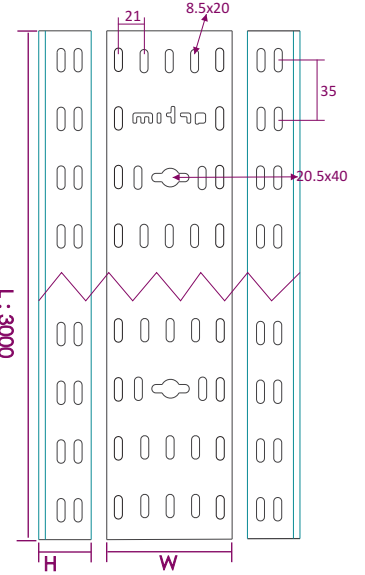
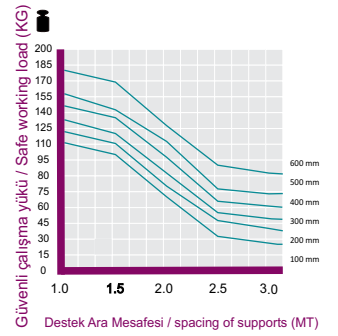

Standart uzunluk L:3000 mm
Toplu miktarlarda Özel ölçüler yapılabilir.
Standard Length L:3000 mm
Custom sizes can be made in bulk quantities.

ARTIM METAL ELEKTRİK A.Ş.

* Farklı kalınlık ve ölçülerde üretim yapılabılır.
* Malzeme ağırlıkları yaklaşık değerlerdir, \pm %10 değişiklik gösterebilir.
* Malzeme kalınlık toleransı \pm %10 dur.
* Lütfen siparişlerinizde sipariş kodu veya ürün kodu ve Kaplama şeklini belirtiniz.

* We can produce cable trays different thickness and dimensions
* Cable trays are shown approximately weight, they could change \pm %10 difference.
* Cable trays thickness tolerances are shown \pm %10 .
* Please indicate order code and coating type in your orders.

H60 AGH SERIES

AGIR HIZMET TIP KABLO KANALI

HEAVY DUTY TYPE CABLE TRAYS

SICAK DALDIRMA (SD)

HOT DIP GALVANIZED (HDG)

TS EN ISO 1461

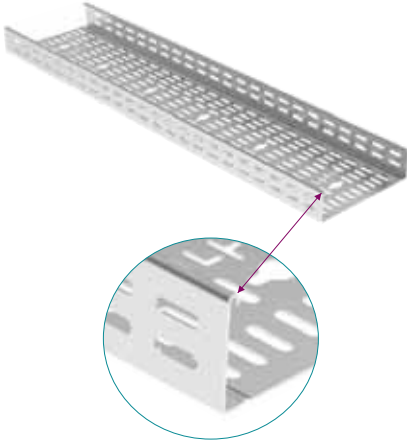

0.80 mm

Sipariş Kodu Order Code	W (mm)	T (mm)	Ağırlık (kg/m) Weight (kg/m)	Barkod Kodu Barcode Code
60 AGH 100-08	100	0.80 mm	1,348	2000410
60 AGH 160-08	160	0.80 mm	1,666	2000412
60 AGH 200-09	200	0.90 mm	2,117	2000413

1.00 mm

Sipariş Kodu Order Code	W (mm)	T (mm)	Ağırlık (kg/m) Weight (kg/m)	Barkod Kodu Barcode Code
60 AGH 100-10	100	1.00 mm	1,686	2000347
60 AGH 160-10	160	1.00 mm	2,083	2000350
60 AGH 200-10	200	1.00 mm	2,352	2000353
60 AGH 300-10	300	1.00 mm	3,009	2000356

1.20 mm

Sipariş Kodu Order Code	W (mm)	T (mm)	Ağırlık (kg/m) Weight (kg/m)	Barkod Kodu Barcode Code
60 AGH 100-12	100	1.20 mm	2,024	2000348
60 AGH 160-12	160	1.20 mm	2,499	2000351
60 AGH 200-12	200	1.20 mm	2,818	2000354
60 AGH 300-12	300	1.20 mm	3,606	2000357
60 AGH 400-12	400	1.20 mm	4,361	2000360
60 AGH 500-12	500	1.20 mm	5,194	2000363

1.50 mm

Sipariş Kodu Order Code	W (mm)	T (mm)	Ağırlık (kg/m) Weight (kg/m)	Barkod Kodu Barcode Code
60 AGH 100-15	100	1.50 mm	2,528	2000349
60 AGH 160-15	160	1.50 mm	3,121	2000352
60 AGH 200-15	200	1.50 mm	3,523	2000355
60 AGH 300-15	300	1.50 mm	4,508	2000358
60 AGH 400-15	400	1.50 mm	5,498	2000361
60 AGH 500-15	500	1.50 mm	6,488	2000364
60 AGH 600-15	600	1.50 mm	7,477	2000366

2.00 mm

Sipariş Kodu Order Code	W (mm)	T (mm)	Ağırlık (kg/m) Weight (kg/m)	Barkod Kodu Barcode Code
60 AGH 100-20	100	2.00 mm	3,430	2000417
60 AGH 160-20	160	2.00 mm	4,235	2000419
60 AGH 200-20	200	2.00 mm	4,781	2000420
60 AGH 300-20	300	2.00 mm	6,170	2000359
60 AGH 400-20	400	2.00 mm	7,306	2000362
60 AGH 500-20	500	2.00 mm	8,653	2000365
60 AGH 600-20	600	2.00 mm	9,967	2000367
60 AGH 700-20	700	2.00 mm	12,794	2000463
60 AGH 800-20	800	2.00 mm	14,328	2000464
60 AGH 900-20	900	2.00 mm	15,861	2000465

H = YÜKSEKLİK = HEIGHT / W = GENİŞLİK = WIDTH / T = KALINLIK = THICKNESS

60 AGH 100 - 10

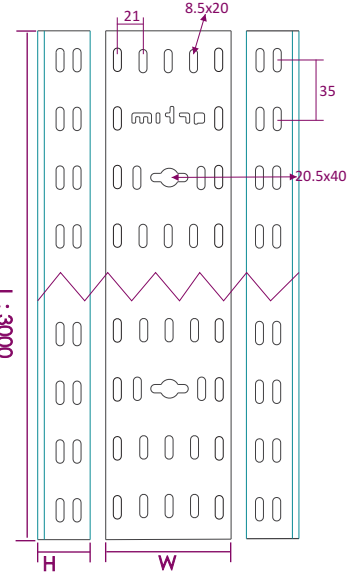
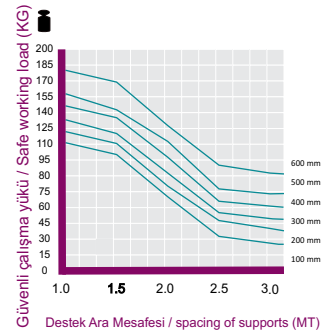

Standart uzunluk L:3000 mm
Toplu miktarlarda Özel ölçüler yapılabilir.
Standard Length L:3000 mm
Custom sizes can be made in bulk quantities.

* Farklı kalınlık ve ölçülerde üretim yapılabılır.
* Malzeme ağırlıkları yaklaşık değerlerdir, ± %10 değişiklik gösterebilir.
* Malzeme kalınlık toleransı ± %10 dur.
* Lütfen siparişlerinizde sipariş kodu veya ürün kodu ve Kaplama şeklini belirtiniz.

* We can produce cable trays different thickness and dimensions
* Cable trays are shown approximately weight, they could change ± %10 difference.
* Cable trays thickness tolerances are shown ± %10 .
* Please indicate order code and coating type in your orders.

H60 AGH SERIES

AGIR HIZMET TIP KABLO KANALI (DELIKSİZ)

HEAVY DUTY TYPE CABLE TRAYS (NON PERFORATED)

PREGALVANIZ (PG)

PREGALVANIZED (PG)

TS EN 10346

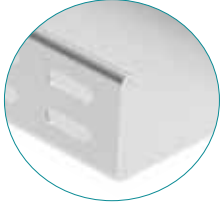

0.80 mm

Sipariş Kodu Order Code	W (mm)	T (mm)	Ağırlık (kg/m) Weight (kg/m)	Barkod Kodu Barcode Code
60 AGH 100-08D	100	0.80 mm	1,406	2000410
60 AGH 160-08D	160	0.80 mm	1,711	2000412
60 AGH 200-09D	200	0.90 mm	2,210	2000413

1.00 mm

Sipariş Kodu Order Code	W (mm)	T (mm)	Ağırlık (kg/m) Weight (kg/m)	Barkod Kodu Barcode Code
60 AGH 100-10D	100	1.00 mm	1,758	2000347
60 AGH 160-10D	160	1.00 mm	2,140	2000350
60 AGH 200-10D	200	1.00 mm	2,456	2000353
60 AGH 300-10D	300	1.00 mm	3,144	2000356

1.20 mm

Sipariş Kodu Order Code	W (mm)	T (mm)	Ağırlık (kg/m) Weight (kg/m)	Barkod Kodu Barcode Code
60 AGH 100-12D	100	1.20 mm	2,114	2000348
60 AGH 160-12D	160	1.20 mm	2,609	2000351
60 AGH 200-12D	200	1.20 mm	2,942	2000354
60 AGH 300-12D	300	1.20 mm	3,770	2000357
60 AGH 400-12D	400	1.20 mm	4,598	2000360
60 AGH 500-12D	500	1.20 mm	5,427	2000363

1.50 mm

Sipariş Kodu Order Code	W (mm)	T (mm)	Ağırlık (kg/m) Weight (kg/m)	Barkod Kodu Barcode Code
60 AGH 100-15D	100	1.50 mm	2,643	2000349
60 AGH 160-15D	160	1.50 mm	3,263	2000352
60 AGH 200-15D	200	1.50 mm	3,680	2000355
60 AGH 300-15D	300	1.50 mm	4,710	2000358
60 AGH 400-15D	400	1.50 mm	5,748	2000361
60 AGH 500-15D	500	1.50 mm	6,779	2000364
60 AGH 600-15D	600	1.50 mm	7,815	2000366

2.00 mm

Sipariş Kodu Order Code	W (mm)	T (mm)	Ağırlık (kg/m) Weight (kg/m)	Barkod Kodu Barcode Code
60 AGH 100-20D	100	2.00 mm	3,586	2000417
60 AGH 160-20D	160	2.00 mm	4,428	2000419
60 AGH 200-20D	200	2.00 mm	4,993	2000420
60 AGH 300-20D	300	2.00 mm	6,288	2000359
60 AGH 400-20D	400	2.00 mm	7,636	2000362
60 AGH 500-20D	500	2.00 mm	9,045	2000365
60 AGH 600-20D	600	2.00 mm	10,419	2000367
60 AGH 700-20D	700	2.00 mm	12,439	2000466
60 AGH 800-20D	800	2.00 mm	13,931	2000467
60 AGH 900-20D	900	2.00 mm	15,422	2000468

H = YÜKSEKLİK = HEIGHT / W = GENİŞLİK = WIDTH / T = KALINLIK = THICKNESS

60 AGH 100-10D

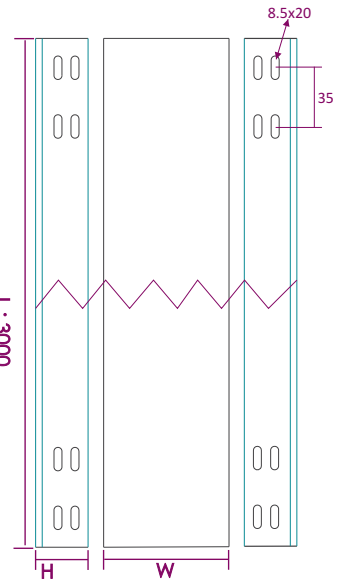
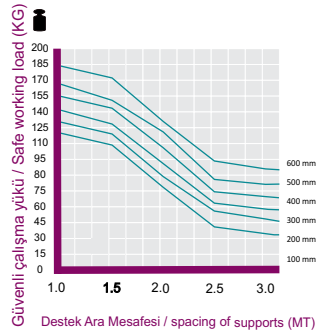

Standart uzunluk L:3000 mm
Toplu miktarlarda Özel ölçüler yapılabilir.
Standard Length L:3000 mm
Custom sizes can be made in bulk quantities.

ARTIM METAL ELEKTRİK A.Ş.

- * Farklı kalınlık ve ölçülerde üretim yapılabılır.
- * Malzeme ağırlıkları yaklaşık değerlerdir, \pm %10 değişiklik gösterebilir.
- * Malzeme kalınlık toleransı \pm %10 dur.
- * Lütfen siparişlerinizde sipariş kodu veya ürün kodu ve Kaplama şeklini belirtiniz.

- * We can produce cable trays different thickness and dimensions
- * Cable trays are shown approximately weight, they could change \pm %10 difference.
- * Cable trays thickness tolerances are shown \pm %10 .
- * Please indicate order code and coating type in your orders.

H60 AGH SERIES

AGIR HIZMET TIP KABLO KANALI (DELIKSIZ)

HEAVY DUTY TYPE CABLE TRAYS (NON PERFORATE)

SICAK DALDIRMA (SD)
HOT DIP GALVANIZED (HDG)
TS EN ISO 1461



0.80 mm

Sipariş Kodu Order Code	W (mm)	T (mm)	Ağırlık (kg/m) Weight (kg/m)	Barkod Kodu Barcode Code
60 AGH 100-08D	100	0.80 mm	1,550	2000410
60 AGH 160-08D	160	0.80 mm	1,916	2000412
60 AGH 200-09D	200	0.90 mm	2,435	2000413

1.00 mm

Sipariş Kodu Order Code	W (mm)	T (mm)	Ağırlık (kg/m) Weight (kg/m)	Barkod Kodu Barcode Code
60 AGH 100-10D	100	1.00 mm	1,939	2000347
60 AGH 160-10D	160	1.00 mm	2,395	2000350
60 AGH 200-10D	200	1.00 mm	2,705	2000353
60 AGH 300-10D	300	1.00 mm	3,460	2000356

1.20 mm

Sipariş Kodu Order Code	W (mm)	T (mm)	Ağırlık (kg/m) Weight (kg/m)	Barkod Kodu Barcode Code
60 AGH 100-12D	100	1.20 mm	2,328	2000348
60 AGH 160-12D	160	1.20 mm	2,874	2000351
60 AGH 200-12D	200	1.20 mm	3,241	2000354
60 AGH 300-12D	300	1.20 mm	4,147	2000357
60 AGH 400-12D	400	1.20 mm	5,015	2000360
60 AGH 500-12D	500	1.20 mm	5,973	2000363

1.50 mm

Sipariş Kodu Order Code	W (mm)	T (mm)	Ağırlık (kg/m) Weight (kg/m)	Barkod Kodu Barcode Code
60 AGH 100-15D	100	1.50 mm	2,907	2000349
60 AGH 160-15D	160	1.50 mm	3,589	2000352
60 AGH 200-15D	200	1.50 mm	4,051	2000355
60 AGH 300-15D	300	1.50 mm	5,184	2000358
60 AGH 400-15D	400	1.50 mm	6,323	2000361
60 AGH 500-15D	500	1.50 mm	7,461	2000364
60 AGH 600-15D	600	1.50 mm	8,599	2000366

2.00 mm

Sipariş Kodu Order Code	W (mm)	T (mm)	Ağırlık (kg/m) Weight (kg/m)	Barkod Kodu Barcode Code
60 AGH 100-20D	100	2.00 mm	3,945	2000417
60 AGH 160-20D	160	2.00 mm	4,870	2000419
60 AGH 200-20D	200	2.00 mm	5,498	2000420
60 AGH 300-20D	300	2.00 mm	7,096	2000359
60 AGH 400-20D	400	2.00 mm	8,402	2000362
60 AGH 500-20D	500	2.00 mm	9,951	2000365
60 AGH 600-20D	600	2.00 mm	11,462	2000367
60 AGH 700-20D	700	2.00 mm	13,683	2000466
60 AGH 800-20D	800	2.00 mm	15,324	2000467
60 AGH 900-20D	900	2.00 mm	16,964	2000468

H = YÜKSEKLİK = HEIGHT / W = GENİŞLİK = WIDTH / T = KALINLIK = THICKNESS

60 AGH 100-10D

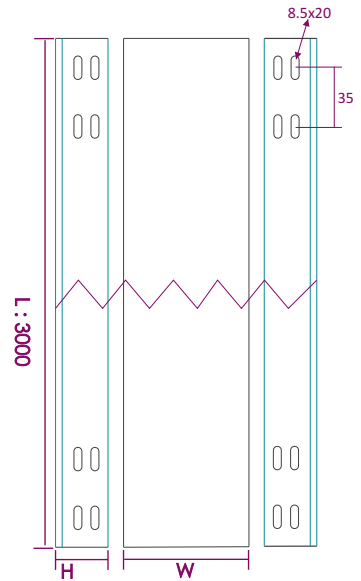
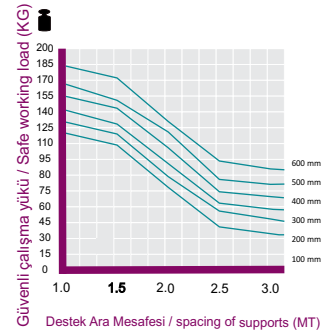

Standart uzunluk L:3000 mm
Toplu miktarlarda Özel ölçüler yapılabilir.
Standard Length L:3000 mm
Custom sizes can be made in bulk quantities.

* Farklı kalınlık ve ölçülerde üretim yapılabılır.
* Malzeme ağırlıkları yaklaşık değerlerdir, \pm %10 değişiklik gösterebilir.
* Malzeme kalınlık toleransı \pm %10 dur.
* Lütfen siparişlerinizde sipariş kodu veya ürün kodu ve Kaplama şeklini belirtiniz.

* We can produce cable trays different thickness and dimensions
* Cable trays are shown approximately weight, they could change \pm %10 difference.
* Cable trays thickness tolerances are shown \pm %10 .
* Please indicate order code and coating type in your orders.

H60 AST SERIES

STANDART TIP KABLO KANALI

MEDIUM DUTY CABLE TRAYS

PREGALVANİZ (PG)
PREGALVANIZED (PG)
TS EN 10346

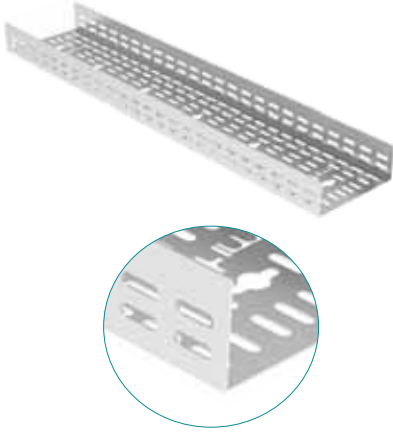

Sipariş Kodu Order Code	W (mm)	T (mm)	Ağırlık (kg/m) Weight (kg/m)	Barkod Kodu Barcode Code
60 AST 100-10	100	1.00 mm	1,451	2000168
60 AST 160-10	160	1.00 mm	1,911	2000170
60 AST 200-10	200	1.00 mm	2,048	2000171

1.00 mm

Sipariş Kodu Order Code	W (mm)	T (mm)	Ağırlık (kg/m) Weight (kg/m)	Barkod Kodu Barcode Code
60 AST 100-12	100	1.20 mm	1,736	2000172
60 AST 160-12	160	1.20 mm	2,293	2000174
60 AST 200-12	200	1.20 mm	2,457	2000175
60 AST 300-12	300	1.20 mm	3,177	2000176

1.20 mm

Sipariş Kodu Order Code	W (mm)	T (mm)	Ağırlık (kg/m) Weight (kg/m)	Barkod Kodu Barcode Code
60 AST 100-15	100	1.50 mm	2,156	2000177
60 AST 160-15	160	1.50 mm	2,676	2000179
60 AST 200-15	200	1.50 mm	3,057	2000180
60 AST 300-15	300	1.50 mm	3,959	2000181
60 AST 400-15	400	1.50 mm	4,855	2000182
60 AST 500-15	500	1.50 mm	5,757	2000183
60 AST 600-15	600	1.50 mm	6,654	2000184

1.50 mm

Sipariş Kodu Order Code	W (mm)	T (mm)	Ağırlık (kg/m) Weight (kg/m)	Barkod Kodu Barcode Code
60 AST 100-20	100	2.00 mm	2,925	2000185
60 AST 160-20	160	2.00 mm	3,631	2000187
60 AST 200-20	200	2.00 mm	4,148	2000188
60 AST 300-20	300	2.00 mm	5,281	2000189
60 AST 400-20	400	2.00 mm	6,482	2000190
60 AST 500-20	500	2.00 mm	7,682	2000191
60 AST 600-20	600	2.00 mm	8,878	2000192
60 AST 700-20	700	2.00 mm	11,352	2000469
60 AST 800-20	800	2.00 mm	12,745	2000470
60 AST 900-20	900	2.00 mm	14,141	2000471

2.00 mm

H = YÜKSEKLİK = HEIGHT / W = GENİŞLİK = WIDTH / T = KALINLIK = THICKNESS

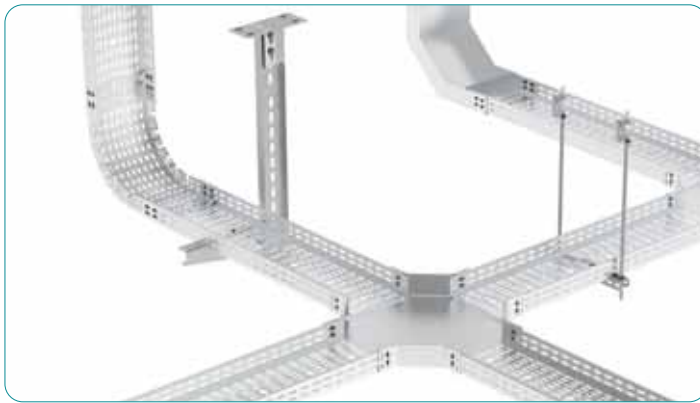

ARTIM METAL ELEKTRİK A.Ş.

60 AST 100-10

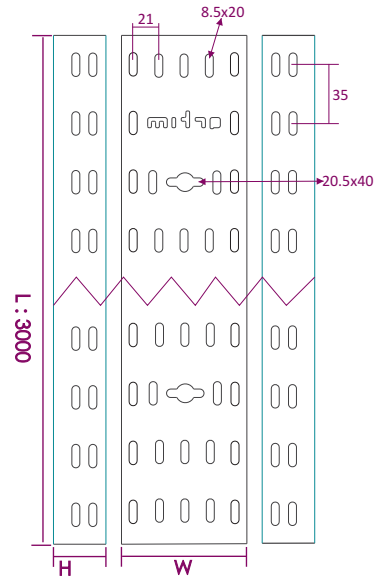
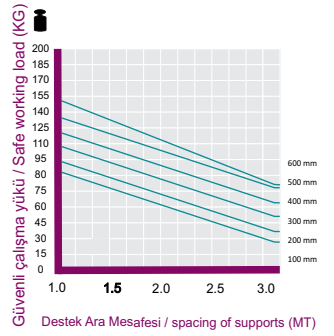

Standart uzunluk L:3000 mm
Toplu miktarlarda Özel ölçüler yapılabilir.
Standard Length L:3000 mm
Custom sizes can be made in bulk quantities.

* Farklı kalınlık ve ölçülerde üretim yapılabılır.
* Malzeme ağırlıkları yaklaşık değerlerdir, ± %10 değişiklik gösterebilir.
* Malzeme kalınlık toleransı ± %10 dur.
* Lütfen siparişlerinizde sipariş kodu veya ürün kodu ve Kaplama şeklini belirtiniz.

* We can produce cable trays different thickness and dimensions
* Cable trays are shown approximately weight, they could change ± %10 difference.
* Cable trays thickness tolerances are shown ± %10 .
* Please indicate order code and coating type in your orders.

H60 AST SERIES

STANDART TIP KABLO KANALI

MEDIUM DUTY CABLE TRAYS

SICAK DALDIRMA (SD)

HOT DIP GALVANIZED (HDG)

TS EN ISO 1461

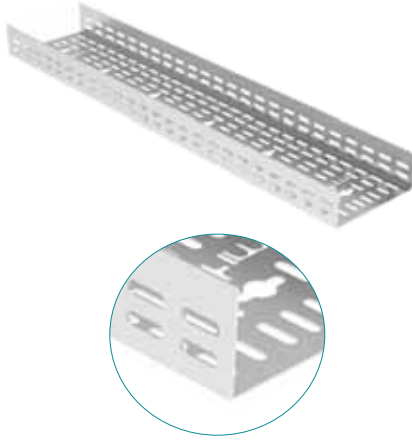

1.00 mm

Sipariş Kodu Order Code	W (mm)	T (mm)	Ağırlık (kg/m) Weight (kg/m)	Barkod Kodu Barcode Code
60 AST 100-10	100	1.00 mm	1,591	2000169
60 AST 160-10	160	1.00 mm	1,925	2000171
60 AST 200-10	200	1.00 mm	2,253	2000172

1.20 mm

Sipariş Kodu Order Code	W (mm)	T (mm)	Ağırlık (kg/m) Weight (kg/m)	Barkod Kodu Barcode Code
60 AST 100-12	100	1.20 mm	1,910	2000174
60 AST 160-12	160	1.20 mm	2,310	2000176
60 AST 200-12	200	1.20 mm	2,704	2000177
60 AST 300-12	300	1.20 mm	3,493	2000178

1.50 mm

Sipariş Kodu Order Code	W (mm)	T (mm)	Ağırlık (kg/m) Weight (kg/m)	Barkod Kodu Barcode Code
60 AST 100-15	100	1.50 mm	2,372	2000179
60 AST 160-15	160	1.50 mm	2,695	2000181
60 AST 200-15	200	1.50 mm	3,361	2000182
60 AST 300-15	300	1.50 mm	4,351	2000183
60 AST 400-15	400	1.50 mm	5,341	2000184
60 AST 500-15	500	1.50 mm	6,331	2000185
60 AST 600-15	600	1.50 mm	7,321	2000186

2.00 mm

Sipariş Kodu Order Code	W (mm)	T (mm)	Ağırlık (kg/m) Weight (kg/m)	Barkod Kodu Barcode Code
60 AST 100-20	100	2.00 mm	3,218	2000188
60 AST 160-20	160	2.00 mm	3,656	2000190
60 AST 200-20	200	2.00 mm	4,561	2000191
60 AST 300-20	300	2.00 mm	5,808	2000192
60 AST 400-20	400	2.00 mm	7,131	2000193
60 AST 500-20	500	2.00 mm	8,449	2000194
60 AST 600-20	600	2.00 mm	9,762	2000195
60 AST 700-20	700	2.00 mm	12,487	2000469
60 AST 800-20	800	2.00 mm	14,020	2000470
60 AST 900-20	900	2.00 mm	15,555	2000471

H = YÜKSEKLİK = HEIGHT / W = GENİŞLİK = WIDTH / T = KALINLIK = THICKNESS



60 AST 100-10

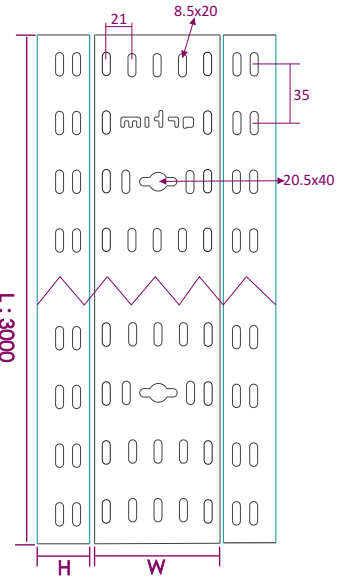
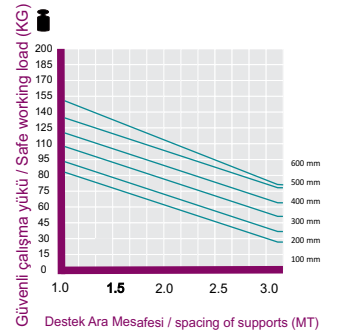

Standart uzunluk L:3000 mm
Toplu miktarlarda Özel ölçüler yapılabilir.
Standard Length L:3000 mm
Custom sizes can be made in bulk quantities.

* Farklı kalınlık ve ölçülerde üretim yapıla bilinir.
* Malzeme ağırlıkları yaklaşık değerlerdir, ± %10 değişiklik gösterebilir.
* Malzeme kalınlık toleransı ± %10 dur.
* Lütfen siparişlerinizde sipariş kodu veya ürün kodu ve Kaplama şeklini belirtiniz.

* We can produce cable trays different thickness and dimensions
* Cable trays are shown approximately weight, they could change ± %10 difference.
* Cable trays thickness tolerances are shown ± %10 .
* Please indicate order code and coating type in your orders.

H60 AST SERIES

STANDART TIP KABLO KANALI (DELİKSİZ)

MEDIUM DUTY CABLE TRAYS (NON PERFORATED)

PREGALVANİZ (PG)
PREGALVANIZED (PG)
TS EN 10346

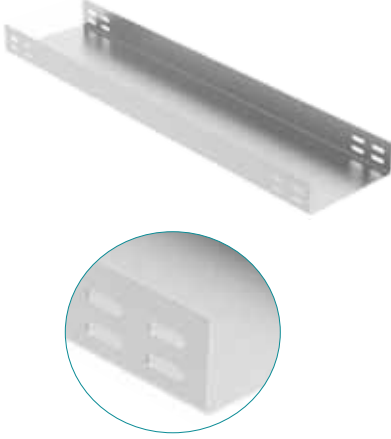

1.50 mm

Sipariş Kodu Order Code	W (mm)	T (mm)	Ağırlık (kg/m) Weight (kg/m)	Barkod Kodu Barcode Code
60 AST 100-15D	100	1.50 mm	2,479	2000177
60 AST 160-15D	160	1.50 mm	3,077	2000179
60 AST 200-15D	200	1.50 mm	3,516	2000180
60 AST 300-15D	300	1.50 mm	4,553	2000181
60 AST 400-15D	400	1.50 mm	5,583	2000182
60 AST 500-15D	500	1.50 mm	6,621	2000183
60 AST 600-15D	600	1.50 mm	7,652	2000184

2.00 mm

Sipariş Kodu Order Code	W (mm)	T (mm)	Ağırlık (kg/m) Weight (kg/m)	Barkod Kodu Barcode Code
60 AST 100-20D	100	2.00 mm	3,364	2000185
60 AST 160-20D	160	2.00 mm	4,176	2000187
60 AST 200-20D	200	2.00 mm	4,770	2000188
60 AST 300-20D	300	2.00 mm	6,073	2000189
60 AST 400-20D	400	2.00 mm	7,454	2000190
60 AST 500-20D	500	2.00 mm	8,834	2000191
60 AST 600-20D	600	2.00 mm	10,210	2000192
60 AST 700-20D	700	2.00 mm	12,141	2000472
60 AST 800-20D	800	2.00 mm	13,632	2000473
60 AST 900-20D	900	2.00 mm	15,124	2000474

H = YÜKSEKLİK = HEIGHT / W = GENİŞLİK = WIDTH / T = KALINLIK = THICKNESS

60 AST 100-10D

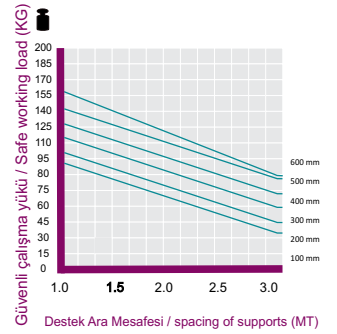

SICAK DALDIRMA (SD)
HOT DIP GALVANIZED (HDG)
TS EN ISO 1461

1.50 mm

Sipariş Kodu Order Code	W (mm)	T (mm)	Ağırlık (kg/m) Weight (kg/m)	Barkod Kodu Barcode Code
60 AST 100-15D	100	1.50 mm	2,728	2000179
60 AST 160-15D	160	1.50 mm	3,099	2000181
60 AST 200-15D	200	1.50 mm	3,865	2000182
60 AST 300-15D	300	1.50 mm	5,004	2000183
60 AST 400-15D	400	1.50 mm	6,142	2000184
60 AST 500-15D	500	1.50 mm	7,281	2000185
60 AST 600-15D	600	1.50 mm	8,419	2000186

2.00 mm

Sipariş Kodu Order Code	W (mm)	T (mm)	Ağırlık (kg/m) Weight (kg/m)	Barkod Kodu Barcode Code
60 AST 100-20D	100	2.00 mm	3,701	2000188
60 AST 160-20D	160	2.00 mm	4,204	2000190
60 AST 200-20D	200	2.00 mm	5,245	2000191
60 AST 300-20D	300	2.00 mm	6,679	2000192
60 AST 400-20D	400	2.00 mm	8,201	2000193
60 AST 500-20D	500	2.00 mm	9,716	2000194
60 AST 600-20D	600	2.00 mm	11,226	2000195
60 AST 700-20D	700	2.00 mm	13,355	2000472
60 AST 800-20D	800	2.00 mm	14,995	2000473
60 AST 900-20D	900	2.00 mm	16,636	2000474

H = YÜKSEKLİK = HEIGHT / W = GENİŞLİK = WIDTH / T = KALINLIK = THICKNESS

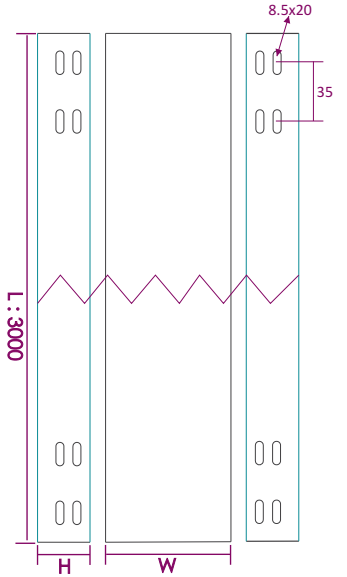

Standart uzunluk L:3000 mm
Toplu miktarlarda Özel ölçüler yapılabilir.
Standard Length L:3000 mm
Custom sizes can be made in bulk quantities.

ARTIM METAL ELEKTRİK A.Ş.

* Farklı kalınlık ve ölçülerde üretim yapılabılır.
* Malzeme ağırlıkları yaklaşık değerlerdir, \pm %10 değişiklik gösterebilir.
* Malzeme kalınlık toleransı \pm %10 dur.
* Lütfen siparişlerinizde sipariş kodu veya ürün kodu ve Kaplama şeklini belirtiniz.

* We can produce cable trays different thickness and dimensions
* Cable trays are shown approximately weight, they could change \pm %10 difference.
* Cable trays thickness tolerances are shown \pm %10 .
* Please indicate order code and coating type in your orders.

AGH SERIES

ÖZEL KABLO KANALLARI

SPECIAL CABLE TRAYS

SICAK DALDIRMA (SD)

HOT DIP GALVANIZED (HDG)

TS EN ISO 1461

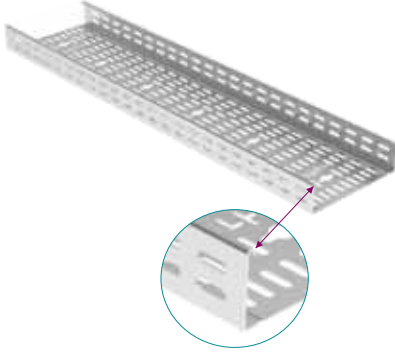

1.50 mm

Sipariş Kodu Order Code	W (mm)	T (mm)	Ağırlık (kg/m) Weight (kg/m)	Barkod Kodu Barcode Code
75 AGH 100-15	100	1.50 mm	2,745	2000501
75 AGH 200-15	200	1.50 mm	3,740	2000502
75 AGH 300-15	300	1.50 mm	4,712	2000503
75 AGH 400-15	400	1.50 mm	5,659	2000504
75 AGH 500-15	500	1.50 mm	6,662	2000505
75 AGH 600-15	600	1.50 mm	7,666	2000506

2.00 mm

Sipariş Kodu Order Code	W (mm)	T (mm)	Ağırlık (kg/m) Weight (kg/m)	Barkod Kodu Barcode Code
75 AGH 100-20	100	2.00 mm	3,725	2000507
75 AGH 200-20	200	2.00 mm	5,076	2000508
75 AGH 300-20	300	2.00 mm	6,395	2000509
75 AGH 400-20	400	2.00 mm	7,680	2000510
75 AGH 500-20	500	2.00 mm	9,042	2000511
75 AGH 600-20	600	2.00 mm	10,404	2000512

H = YÜKSEKLİK = HEIGHT / W = GENİŞLİK = WIDTH / T = KALINLIK = THICKNESS

1.50 mm

Sipariş Kodu Order Code	W (mm)	T (mm)	Ağırlık (kg/m) Weight (kg/m)	Barkod Kodu Barcode Code
80 AGH 100-15Z	100	1.50 mm	3,519	2000513
80 AGH 200-15Z	200	1.50 mm	4,715	2000514
80 AGH 300-15Z	300	1.50 mm	5,912	2000515
80 AGH 400-15Z	400	1.50 mm	7,109	2000516
80 AGH 500-15Z	500	1.50 mm	8,306	2000517
80 AGH 600-15Z	600	1.50 mm	9,503	2000518

2.00 mm

Sipariş Kodu Order Code	W (mm)	T (mm)	Ağırlık (kg/m) Weight (kg/m)	Barkod Kodu Barcode Code
80 AGH 100-20Z	100	2.00 mm	4,775	2000519
80 AGH 200-20Z	200	2.00 mm	6,400	2000520
80 AGH 300-20Z	300	2.00 mm	8,024	2000521
80 AGH 400-20Z	400	2.00 mm	9,648	2000522
80 AGH 500-20Z	500	2.00 mm	11,272	2000523
80 AGH 600-20Z	600	2.00 mm	12,896	2000524

H = YÜKSEKLİK = HEIGHT / W = GENİŞLİK = WIDTH / T = KALINLIK = THICKNESS

1.50 mm

Sipariş Kodu Order Code	W (mm)	T (mm)	Ağırlık (kg/m) Weight (kg/m)	Barkod Kodu Barcode Code
AKK 140-15Z	140	1.50 mm	1,975	2000525
AKK 240-15Z	240	1.50 mm	3,172	2000526
AKK 340-15Z	340	1.50 mm	4,368	2000527
AKK 440-15Z	440	1.50 mm	5,565	2000528
AKK 540-15Z	540	1.50 mm	6,762	2000529
AKK 640-15Z	640	1.50 mm	7,959	2000530

75 AGH 200-15

Yükseklik | Kanal Tipi | Genişlik | Kalınlık
Height | Type | Width | Thickness



Standart uzunluk L:3000 mm
Toplu miktarlarda Özel ölçüler yapılabilir.
Standard Length L:3000 mm
Custom sizes can be made in bulk quantities.

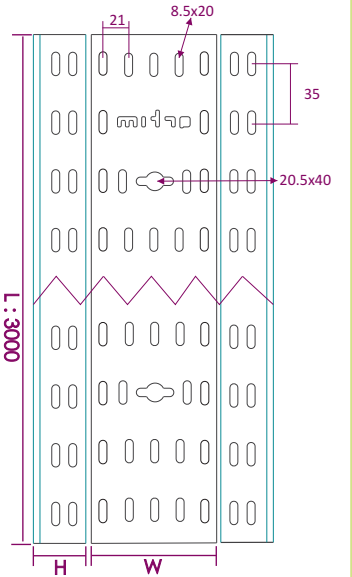

Standart uzunluk L:3000 mm
Toplu miktarlarda Özel ölçüler yapılabilir.
Standard Length L:3000 mm
Custom sizes can be made in bulk quantities.

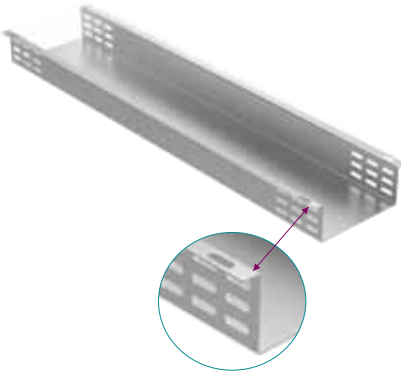

* Farklı kalınlık ve ölçülerde üretim yapılabılır.
* Malzeme ağırlıkları yaklaşık değerlerdir, ± %10 değişiklik gösterebilir.
* Malzeme kalınlık toleransı ± %10 dur.
* Lütfen siparişlerinizde sipariş kodu veya ürün kodu ve Kaplama şeklini belirtiniz.

* We can produce cable trays different thickness and dimensions
* Cable trays are shown approximately weight, they could change ± %10 difference.
* Cable trays thickness tolerances are shown ± %10 .
* Please indicate order code and coating type in your orders.

H100 AGH SERIES

AGIR HIZMET TIP KABLO KANALI

HEAVY DUTY TYPE CABLE TRAYS

PREGALVANIZ (PG)
PREGALVANIZED (PG)
TS EN 10346

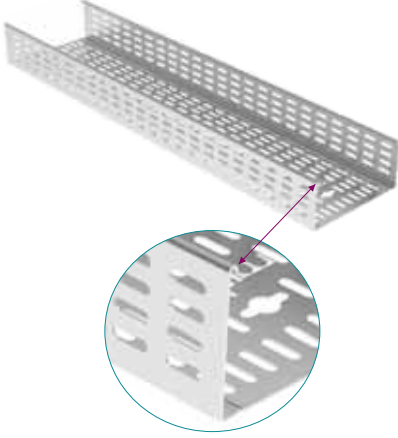

Sipariş Kodu Order Code	W (mm)	T (mm)	Ağırlık (kg/m) Weight (kg/m)	Barkod Kodu Barcode Code
100 AGH 100-10	100	1.00 mm	1,995	2000475
100 AGH 160-10	160	1.00 mm	2,377	2000477
100 AGH 200-10	200	1.00 mm	2,590	2000478
100 AGH 300-10	300	1.00 mm	3,190	2000479
100 AGH 400-10	400	1.00 mm	3,780	2000480

Sipariş Kodu Order Code	W (mm)	T (mm)	Ağırlık (kg/m) Weight (kg/m)	Barkod Kodu Barcode Code
100 AGH 100-12	100	1.20 mm	2,395	2000421
100 AGH 160-12	160	1.20 mm	2,853	2000423
100 AGH 200-12	200	1.20 mm	3,108	2000424
100 AGH 300-12	300	1.20 mm	3,828	2000425
100 AGH 400-12	400	1.20 mm	4,536	2000426
100 AGH 500-12	500	1.20 mm	5,250	2000427

Sipariş Kodu Order Code	W (mm)	T (mm)	Ağırlık (kg/m) Weight (kg/m)	Barkod Kodu Barcode Code
100 AGH 100-15	100	1.50 mm	2,994	2000368
100 AGH 160-15	160	1.50 mm	3,567	2000370
100 AGH 200-15	200	1.50 mm	3,886	2000372
100 AGH 300-15	300	1.50 mm	4,782	2000374
100 AGH 400-15	400	1.50 mm	5,670	2000429
100 AGH 500-15	500	1.50 mm	6,563	2000430
100 AGH 600-15	600	1.50 mm	7,456	2000431

Sipariş Kodu Order Code	W (mm)	T (mm)	Ağırlık (kg/m) Weight (kg/m)	Barkod Kodu Barcode Code
100 AGH 100-20	100	2.00 mm	3,994	2000369
100 AGH 160-20	160	2.00 mm	4,756	2000371
100 AGH 200-20	200	2.00 mm	5,184	2000373
100 AGH 300-20	300	2.00 mm	6,375	2000375
100 AGH 400-20	400	2.00 mm	7,561	2000376
100 AGH 500-20	500	2.00 mm	8,751	2000377
100 AGH 600-20	600	2.00 mm	9,942	2000378
100 AGH 700-20	700	2.00 mm	11,587	2000486
100 AGH 800-20	800	2.00 mm	12,855	2000487
100 AGH 900-20	900	2.00 mm	14,123	2000488

H = YÜKSEKLİK = HEIGHT / W = GENİŞLİK = WIDTH / T = KALINLIK = THICKNESS

1.00 mm

1.20 mm

1.50 mm

2.00 mm

100 AGH 100 - 10

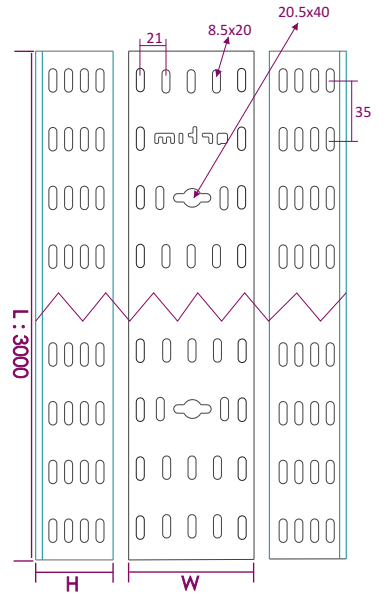
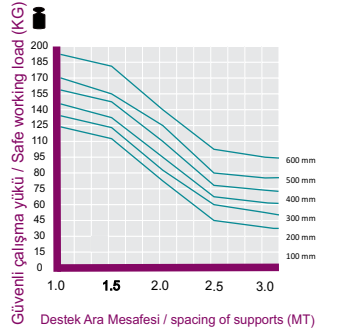

Standart uzunluk L:3000 mm
Toplu miktarlarda Özel ölçüler yapılabilir.
Standard Length L:3000 mm
Custom sizes can be made in bulk quantities.

ARTIM METAL ELEKTRİK A.Ş.

- * Farklı kalınlık ve ölçülerde üretim yapılabılır.
- * Malzeme ağırlıkları yaklaşık değerlerdir, ± %10 değişiklik gösterebilir.
- * Malzeme kalınlık toleransı ± %10 dur.
- * Lütfen siparişlerinizde sipariş kodu veya ürün kodu ve Kaplama şeklini belirtiniz.

- * We can produce cable trays different thickness and dimensions
- * Cable trays are shown approximately weight, they could change ± %10 difference.
- * Cable trays thickness tolerances are shown ± %10 .
- * Please indicate order code and coating type in your orders.

H100 AGH SERIES

AGIR HIZMET TIP KABLO KANALI

HEAVY DUTY TYPE CABLE TRAYS

SICAK DALDIRMA (SD)
HOT DIP GALVANIZED (SD)
TS EN ISO 1461

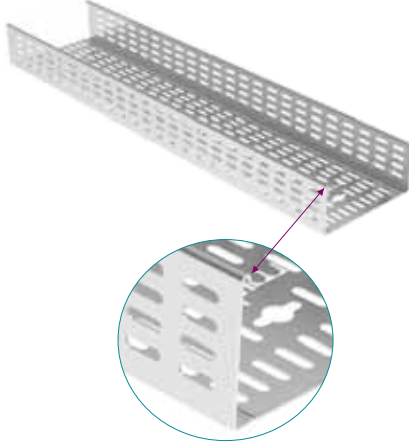

Sipariş Kodu Order Code	W (mm)	T (mm)	Ağırlık (kg/m) Weight (kg/m)	Barkod Kodu Barcode Code
100 AGH 100-10	100	1.00 mm	2,175	2000475
100 AGH 160-10	160	1.00 mm	2,590	2000477
100 AGH 200-10	200	1.00 mm	2,822	2000478
100 AGH 300-10	300	1.00 mm	3,476	2000479
100 AGH 400-10	400	1.00 mm	4,120	2000480

Sipariş Kodu Order Code	W (mm)	T (mm)	Ağırlık (kg/m) Weight (kg/m)	Barkod Kodu Barcode Code
100 AGH 100-12	100	1.20 mm	2,610	2000421
100 AGH 160-12	160	1.20 mm	3,109	2000423
100 AGH 200-12	200	1.20 mm	3,387	2000424
100 AGH 300-12	300	1.20 mm	4,172	2000425
100 AGH 400-12	400	1.20 mm	4,944	2000426
100 AGH 500-12	500	1.20 mm	5,722	2000427

Sipariş Kodu Order Code	W (mm)	T (mm)	Ağırlık (kg/m) Weight (kg/m)	Barkod Kodu Barcode Code
100 AGH 100-15	100	1.50 mm	3,293	2000368
100 AGH 160-15	160	1.50 mm	3,888	2000370
100 AGH 200-15	200	1.50 mm	4,278	2000372
100 AGH 300-15	300	1.50 mm	5,263	2000374
100 AGH 400-15	400	1.50 mm	6,180	2000429
100 AGH 500-15	500	1.50 mm	7,221	2000430
100 AGH 600-15	600	1.50 mm	8,202	2000431

Sipariş Kodu Order Code	W (mm)	T (mm)	Ağırlık (kg/m) Weight (kg/m)	Barkod Kodu Barcode Code
100 AGH 100-20	100	2.00 mm	4,395	2000369
100 AGH 160-20	160	2.00 mm	5,184	2000371
100 AGH 200-20	200	2.00 mm	5,704	2000373
100 AGH 300-20	300	2.00 mm	7,012	2000375
100 AGH 400-20	400	2.00 mm	8,320	2000376
100 AGH 500-20	500	2.00 mm	9,629	2000377
100 AGH 600-20	600	2.00 mm	10,937	2000378
100 AGH 700-20	700	2.00 mm	12,746	2000486
100 AGH 800-20	800	2.00 mm	14,140	2000487
100 AGH 900-20	900	2.00 mm	15,535	2000488

H = YÜKSEKLİK = HEIGHT / W = GENİŞLİK = WIDTH / T = KALINLIK = THICKNESS

100 AGH 100 - 10

Yükseklik Kanal Tipi Genişlik Kalınlık
Height Type Width Thickness

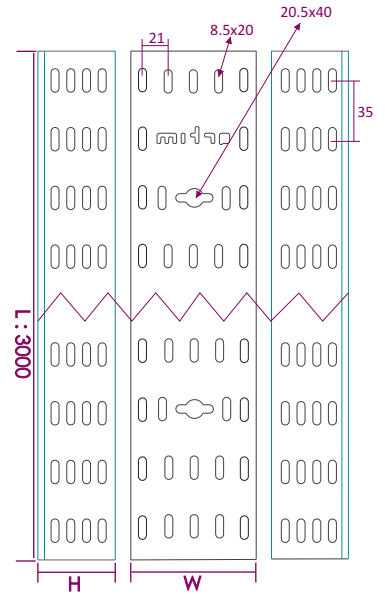
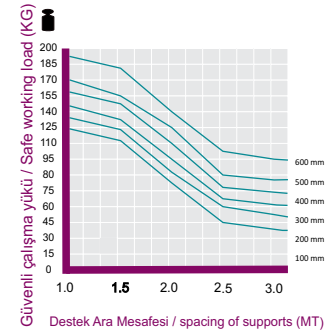

Standart uzunluk L:3000 mm
Toplu miktarlarda Özel ölçüler yapılabilir.
Standard Length L:3000 mm
Custom sizes can be made in bulk quantities.

* Farklı kalınlık ve ölçülerde üretim yapılabılır.
* Malzeme ağırlıkları yaklaşık değerlerdir, \pm %10 değişiklik gösterebilir.
* Malzeme kalınlık toleransı \pm %10 dur.
* Lütfen siparişlerinizde sipariş kodu veya ürün kodu ve Kaplama şeklini belirtiniz.

* We can produce cable trays different thickness and dimensions
* Cable trays are shown approximately weight, they could change \pm %10 difference.
* Cable trays thickness tolerances are shown \pm %10 .
* Please indicate order code and coating type in your orders.

H100 AGH SERIES

AGIR HIZMET KABLO KANALI (DELIKSİZ)

HEAVY DUTY TYPE CABLE TRAYS (NON PERFORATED)

PREGALVANIZ (PG)
PREGALVANIZED (PG)
TS EN 10346



1.00 mm

Sipariş Kodu Order Code	W (mm)	T (mm)	Ağırlık (kg/m) Weight (kg/m)	Barkod Kodu Barcode Code
100 AGH 100-10D	100	1.00 mm	2,295	2000481
100 AGH 160-10D	160	1.00 mm	2,734	2000483
100 AGH 200-10D	200	1.00 mm	2,978	2000484
100 AGH 300-10D	300	1.00 mm	3,668	2000485
100 AGH 400-10D	400	1.00 mm	4,346	2000486

1.20 mm

Sipariş Kodu Order Code	W (mm)	T (mm)	Ağırlık (kg/m) Weight (kg/m)	Barkod Kodu Barcode Code
100 AGH 100-12D	100	1.20 mm	2,754	2000421
100 AGH 160-12D	160	1.20 mm	3,281	2000423
100 AGH 200-12D	200	1.20 mm	3,574	2000424
100 AGH 300-12D	300	1.20 mm	4,402	2000425
100 AGH 400-12D	400	1.20 mm	5,216	2000426
100 AGH 500-12D	500	1.20 mm	6,038	2000427

1.50 mm

Sipariş Kodu Order Code	W (mm)	T (mm)	Ağırlık (kg/m) Weight (kg/m)	Barkod Kodu Barcode Code
100 AGH 100-15D	100	1.50 mm	3,443	2000368
100 AGH 160-15D	160	1.50 mm	4,102	2000370
100 AGH 200-15D	200	1.50 mm	4,469	2000372
100 AGH 300-15D	300	1.50 mm	5,499	2000374
100 AGH 400-15D	400	1.50 mm	6,521	2000429
100 AGH 500-15D	500	1.50 mm	7,547	2000430
100 AGH 600-15D	600	1.50 mm	8,574	2000431

2.00 mm

Sipariş Kodu Order Code	W (mm)	T (mm)	Ağırlık (kg/m) Weight (kg/m)	Barkod Kodu Barcode Code
100 AGH 100-20D	100	2.00 mm	4,593	2000369
100 AGH 160-20D	160	2.00 mm	5,469	2000371
100 AGH 200-20D	200	2.00 mm	5,962	2000373
100 AGH 300-20D	300	2.00 mm	7,331	2000375
100 AGH 400-20D	400	2.00 mm	8,695	2000376
100 AGH 500-20D	500	2.00 mm	10,064	2000377
100 AGH 600-20D	600	2.00 mm	11,433	2000378
100 AGH 700-20D	700	2.00 mm	13,632	2000489
100 AGH 800-20D	800	2.00 mm	15,123	2000490
100 AGH 900-20D	900	2.00 mm	16,615	2000491

H = YÜKSEKLİK = HEIGHT / W = GENİŞLİK = WIDTH / T = KALINLIK = THICKNESS

100 AGH 100-10D

Yükseklik Kanal Tipi Genişlik Kalınlık
Height Type Width Thickness

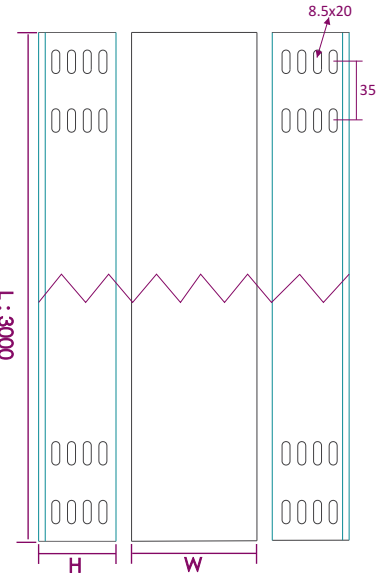
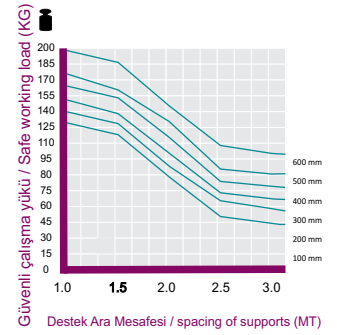

Standart uzunluk L:3000 mm
Toplu miktarlarda Özel ölçüler yapılabilir.
Standard Length L:3000 mm
Custom sizes can be made in bulk quantities.

ARTIM METAL ELEKTRİK A.Ş.

- * Farklı kalınlık ve ölçülerde üretim yapılabılır.
- * Malzeme ağırlıkları yaklaşık değerlerdir, \pm %10 değişiklik gösterebilir.
- * Malzeme kalınlık toleransı \pm %10 dur.
- * Lütfen siparişlerinizde sipariş kodu veya ürün kodu ve Kaplama şeklini belirtiniz.

- * We can produce cable trays different thickness and dimensions
- * Cable trays are shown approximately weight, they could change \pm %10 difference.
- * Cable trays thickness tolerances are shown \pm %10 .
- * Please indicate order code and coating type in your orders.

H100 AGH SERIES

AGIR HIZMET KABLO KANALI (DELIKSİZ)

HEAVY DUTY TYPE CABLE TRAYS (NON PERFORATED)

SICAK DALDIRMA (SD)

HOT DIP GALVANIZED (SD)

TS EN ISO 1461

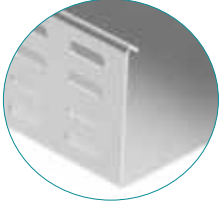

Sipariş Kodu Order Code	W (mm)	T (mm)	Ağırlık (kg/m) Weight (kg/m)	Barkod Kodu Barcode Code
100 AGH 100-10D	100	1.00 mm	2,501	2000481
100 AGH 160-10D	160	1.00 mm	2,979	2000483
100 AGH 200-10D	200	1.00 mm	3,245	2000484
100 AGH 300-10D	300	1.00 mm	3,998	2000485
100 AGH 400-10D	400	1.00 mm	4,738	2000486

Sipariş Kodu Order Code	W (mm)	T (mm)	Ağırlık (kg/m) Weight (kg/m)	Barkod Kodu Barcode Code
100 AGH 100-12D	100	1.20 mm	3,002	2000421
100 AGH 160-12D	160	1.20 mm	3,575	2000423
100 AGH 200-12D	200	1.20 mm	3,895	2000424
100 AGH 300-12D	300	1.20 mm	4,798	2000425
100 AGH 400-12D	400	1.20 mm	5,686	2000426
100 AGH 500-12D	500	1.20 mm	6,580	2000427

Sipariş Kodu Order Code	W (mm)	T (mm)	Ağırlık (kg/m) Weight (kg/m)	Barkod Kodu Barcode Code
100 AGH 100-15D	100	1.50 mm	3,787	2000368
100 AGH 160-15D	160	1.50 mm	4,471	2000370
100 AGH 200-15D	200	1.50 mm	4,920	2000372
100 AGH 300-15D	300	1.50 mm	6,052	2000374
100 AGH 400-15D	400	1.50 mm	7,107	2000429
100 AGH 500-15D	500	1.50 mm	8,304	2000430
100 AGH 600-15D	600	1.50 mm	9,432	2000431

Sipariş Kodu Order Code	W (mm)	T (mm)	Ağırlık (kg/m) Weight (kg/m)	Barkod Kodu Barcode Code
100 AGH 100-20D	100	2.00 mm	5,054	2000369
100 AGH 160-20D	160	2.00 mm	5,962	2000371
100 AGH 200-20D	200	2.00 mm	6,560	2000373
100 AGH 300-20D	300	2.00 mm	8,064	2000375
100 AGH 400-20D	400	2.00 mm	9,568	2000376
100 AGH 500-20D	500	2.00 mm	11,073	2000377
100 AGH 600-20D	600	2.00 mm	12,578	2000378
100 AGH 700-20D	700	2.00 mm	14,995	2000489
100 AGH 800-20D	800	2.00 mm	16,635	2000490
100 AGH 900-20D	900	2.00 mm	18,277	2000491

H = YÜKSEKLİK = HEIGHT / W = GENİŞLİK = WIDTH / T = KALINLIK = THICKNESS

100 AGH 100-10D

Yükseklik Kanal Tipi Genişlik Kalınlık
Height Type Width Thickness

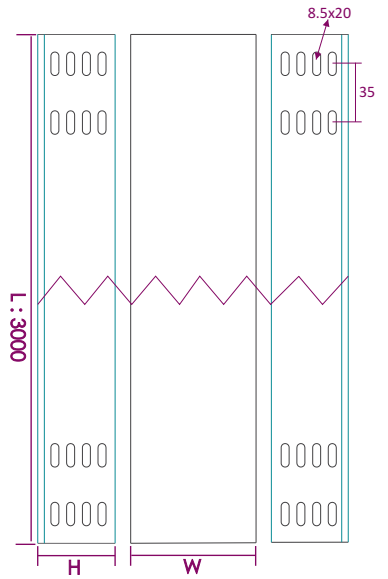
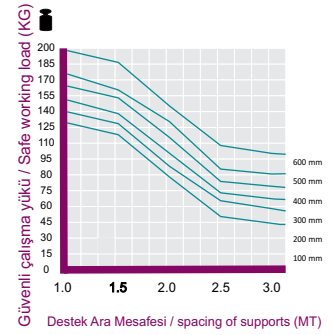

Standart uzunluk L:3000 mm
Toplu miktarlarda Özel ölçüler yapılabilir.
Standard Length L:3000 mm
Custom sizes can be made in bulk quantities.

* Farklı kalınlık ve ölçülerde üretim yapıla bilinir.
* Malzeme ağırlıkları yaklaşık değerlerdir, \pm %10 değişiklik gösterebilir.
* Malzeme kalınlık toleransı \pm %10 dur.
* Lütfen siparişlerinizde sipariş kodu veya ürün kodu ve Kaplama şeklini belirtiniz.

* We can produce cable trays different thickness and dimensions
* Cable trays are shown approximately weight, they could change \pm %10 difference.
* Cable trays thickness tolerances are shown \pm %10 .
* Please indicate order code and coating type in your orders.

H100 AST SERIES

STANDART TIP KABLO KANALLARI

MEDIUM DUTY CABLE TRAYS

PREGALVANİZ (PG)
PREGALVANIZED (PG)
TS EN 10346

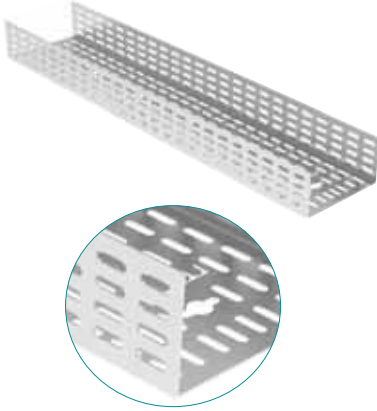

1.00 mm

Sipariş Kodu Order Code	W (mm)	T (mm)	Ağırlık (kg/m) Weight (kg/m)	Barkod Kodu Barcode Code
100 AST 100-10	100	1.00 mm	2,079	2000193
100 AST 160-10	160	1.00 mm	2,539	2000195
100 AST 200-10	200	1.00 mm	2,676	2000196

1.20 mm

Sipariş Kodu Order Code	W (mm)	T (mm)	Ağırlık (kg/m) Weight (kg/m)	Barkod Kodu Barcode Code
100 AST 100-12	100	1.20 mm	2,489	2000197
100 AST 160-12	160	1.20 mm	3,046	2000199
100 AST 200-12	200	1.20 mm	3,210	2000200
100 AST 300-12	300	1.20 mm	3,930	2000201

1.50 mm

Sipariş Kodu Order Code	W (mm)	T (mm)	Ağırlık (kg/m) Weight (kg/m)	Barkod Kodu Barcode Code
100 AST 100-15	100	1.50 mm	3,035	2000202
100 AST 160-15	160	1.50 mm	3,555	2000204
100 AST 200-15	200	1.50 mm	3,936	2000205
100 AST 300-15	300	1.50 mm	4,838	2000206
100 AST 400-15	400	1.50 mm	5,734	2000207
100 AST 500-15	500	1.50 mm	6,636	2000208
100 AST 600-15	600	1.50 mm	7,533	2000209

2.00 mm

Sipariş Kodu Order Code	W (mm)	T (mm)	Ağırlık (kg/m) Weight (kg/m)	Barkod Kodu Barcode Code
100 AST 100-20	100	2.00 mm	4,118	2000210
100 AST 160-20	160	2.00 mm	4,824	2000212
100 AST 200-20	200	2.00 mm	5,341	2000213
100 AST 300-20	300	2.00 mm	6,474	2000214
100 AST 400-20	400	2.00 mm	7,675	2000215
100 AST 500-20	500	2.00 mm	8,875	2000216
100 AST 600-20	600	2.00 mm	10,071	2000217
100 AST 700-20	700	2.00 mm	11,587	2000492
100 AST 800-20	800	2.00 mm	12,855	2000493
100 AST 900-20	900	2.00 mm	14,122	2000494

H = YÜKSEKLİK = HEIGHT / W = GENİŞLİK = WIDTH / T = KALINLIK = THICKNESS

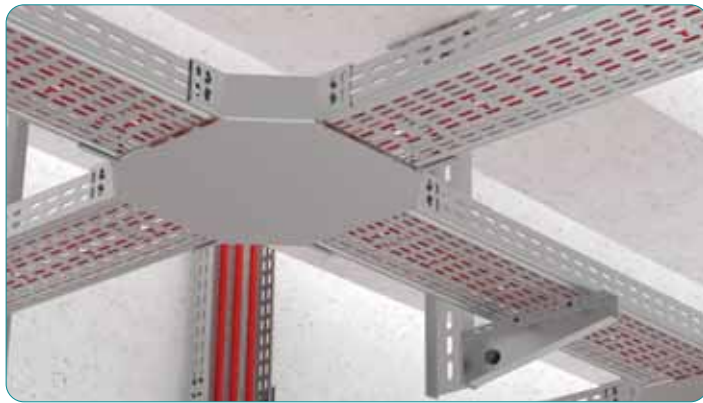

ARTIM METAL ELEKTRİK A.Ş.

100 AST 100 - 10

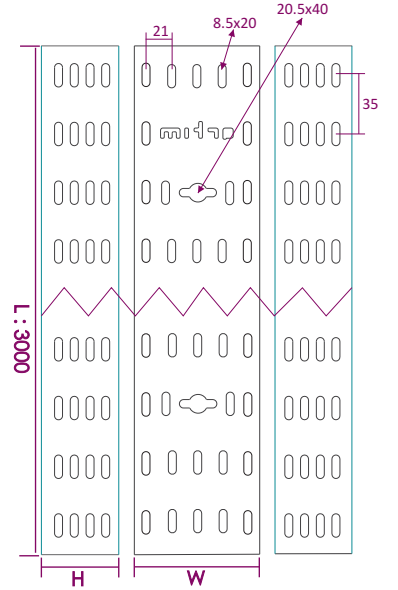
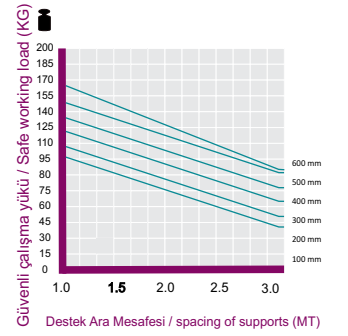

Standart uzunluk L:3000 mm
Toplu miktarlarda Özel ölçüler yapılabilir.
Standard Length L:3000 mm
Custom sizes can be made in bulk quantities.

* Farklı kalınlık ve ölçülerde üretim yapılabılır.
* Malzeme ağırlıkları yaklaşık değerlerdir, ± %10 değişiklik gösterebilir.
* Malzeme kalınlık toleransı ± %10 dur.
* Lütfen siparişlerinizde sipariş kodu veya ürün kodu ve Kaplama şeklini belirtiniz.

* We can produce cable trays different thickness and dimensions
* Cable trays are shown approximately weight, they could change ± %10 difference.
* Cable trays thickness tolerances are shown ± %10 .
* Please indicate order code and coating type in your orders.

H100 AST SERIES

STANDART TIP KABLO KANALLARI

MEDIUM DUTY CABLE TRAYS

SICAK DALDIRMA (SD)
HOT DIP GALVANIZED (SD)
TS EN ISO 1461

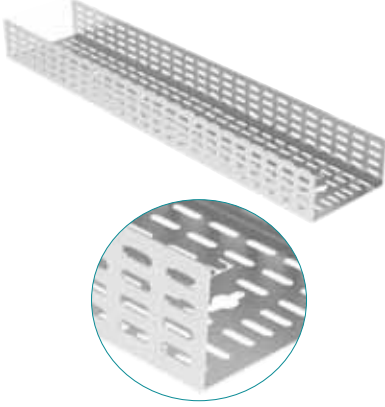

1.00 mm

Sipariş Kodu Order Code	W (mm)	T (mm)	Ağırlık (kg/m) Weight (kg/m)	Barkod Kodu Barcode Code
100 AST 100-10	100	1.00 mm	2,275	2000193
100 AST 160-10	160	1.00 mm	2,609	2000195
100 AST 200-10	200	1.00 mm	2,937	2000196

100 AST 100-10



1.20 mm

Sipariş Kodu Order Code	W (mm)	T (mm)	Ağırlık (kg/m) Weight (kg/m)	Barkod Kodu Barcode Code
100 AST 100-12	100	1.20 mm	2,731	2000197
100 AST 160-12	160	1.20 mm	3,131	2000199
100 AST 200-12	200	1.20 mm	3,525	2000200
100 AST 300-12	300	1.20 mm	4,314	2000201

1.50 mm

Sipariş Kodu Order Code	W (mm)	T (mm)	Ağırlık (kg/m) Weight (kg/m)	Barkod Kodu Barcode Code
100 AST 100-15	100	1.50 mm	3,330	2000202
100 AST 160-15	160	1.50 mm	3,653	2000204
100 AST 200-15	200	1.50 mm	4,319	2000205
100 AST 300-15	300	1.50 mm	5,309	2000206
100 AST 400-15	400	1.50 mm	6,299	2000207
100 AST 500-15	500	1.50 mm	7,289	2000208
100 AST 600-15	600	1.50 mm	8,279	2000209

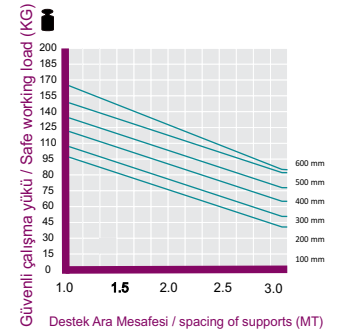

2.00 mm

Sipariş Kodu Order Code	W (mm)	T (mm)	Ağırlık (kg/m) Weight (kg/m)	Barkod Kodu Barcode Code
100 AST 100-20	100	2.00 mm	4,518	2000210
100 AST 160-20	160	2.00 mm	4,956	2000212
100 AST 200-20	200	2.00 mm	5,861	2000213
100 AST 300-20	300	2.00 mm	7,108	2000214
100 AST 400-20	400	2.00 mm	8,431	2000215
100 AST 500-20	500	2.00 mm	9,749	2000216
100 AST 600-20	600	2.00 mm	11,062	2000217
100 AST 700-20	700	2.00 mm	12,746	2000492
100 AST 800-20	800	2.00 mm	14,141	2000493
100 AST 900-20	900	2.00 mm	15,534	2000494

H = YÜKSEKLİK = HEIGHT / W = GENİŞLİK = WIDTH / T = KALINLIK = THICKNESS

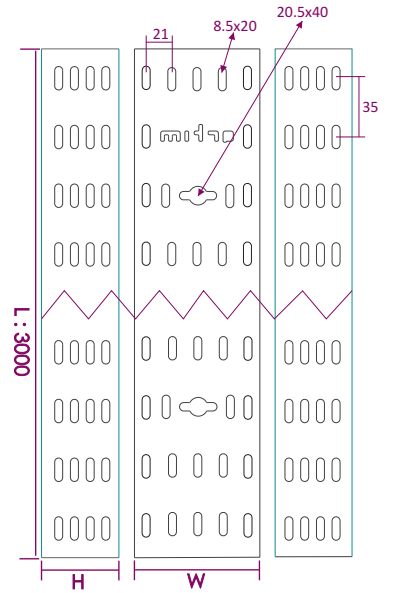

Standart uzunluk L:3000 mm
Toplu miktarlarda Özel ölçüler yapılabilir.
Standard Length L:3000 mm
Custom sizes can be made in bulk quantities.



* Farklı kalınlık ve ölçülerde üretim yapılabılır.
* Malzeme ağırlıkları yaklaşık değerlerdir, ± %10 değişiklik gösterebilir.
* Malzeme kalınlık toleransı ± %10 dur.
* Lütfen siparişlerinizde sipariş kodu veya ürün kodu ve Kaplama şeklini belirtiniz.

* We can produce cable trays different thickness and dimensions
* Cable trays are shown approximately weight, they could change ± %10 difference.
* Cable trays thickness tolerances are shown ± %10 .
* Please indicate order code and coating type in your orders.

H100 AST SERIES

STANDART TİP KABLO KANALLARI (DELİKSİZ)

MEDIUM DUTY CABLE TRAYS (NON PERFORATED)

PREGALVANİZ (PG)
PREGALVANİZED (PG)
TS EN 10346

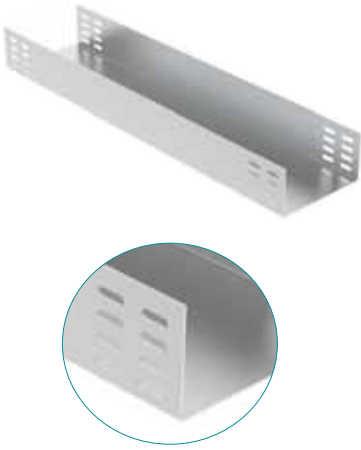

1.00 mm

Sipariş Kodu Order Code	W (mm)	T (mm)	Ağırlık (kg/m) Weight (kg/m)	Barkod Kodu Barcode Code
100 AST 100-10D	100	1.00 mm	2,391	2000193
100 AST 160-10D	160	1.00 mm	2,920	2000195
100 AST 200-10D	200	1.00 mm	3,077	2000196

1.20 mm

Sipariş Kodu Order Code	W (mm)	T (mm)	Ağırlık (kg/m) Weight (kg/m)	Barkod Kodu Barcode Code
100 AST 100-12D	100	1.20 mm	2,862	2000197
100 AST 160-12D	160	1.20 mm	3,503	2000199
100 AST 200-12D	200	1.20 mm	3,692	2000200
100 AST 300-12D	300	1.20 mm	4,520	2000201

1.50 mm

Sipariş Kodu Order Code	W (mm)	T (mm)	Ağırlık (kg/m) Weight (kg/m)	Barkod Kodu Barcode Code
100 AST 100-15D	100	1.50 mm	3,490	2000202
100 AST 160-15D	160	1.50 mm	4,088	2000204
100 AST 200-15D	200	1.50 mm	4,526	2000205
100 AST 300-15D	300	1.50 mm	5,564	2000206
100 AST 400-15D	400	1.50 mm	6,594	2000207
100 AST 500-15D	500	1.50 mm	7,631	2000208
100 AST 600-15D	600	1.50 mm	8,663	2000209

2.00 mm

Sipariş Kodu Order Code	W (mm)	T (mm)	Ağırlık (kg/m) Weight (kg/m)	Barkod Kodu Barcode Code
100 AST 100-20D	100	2.00 mm	4,736	2000210
100 AST 160-20D	160	2.00 mm	5,548	2000212
100 AST 200-20D	200	2.00 mm	6,142	2000213
100 AST 300-20D	300	2.00 mm	7,445	2000214
100 AST 400-20D	400	2.00 mm	8,826	2000215
100 AST 500-20D	500	2.00 mm	10,206	2000216
100 AST 600-20D	600	2.00 mm	11,582	2000217
100 AST 700-20D	700	2.00 mm	13,632	2000495
100 AST 800-20D	800	2.00 mm	15,124	2000496
100 AST 900-20D	900	2.00 mm	16,615	2000497

H = YÜKSEKLİK = HEIGHT / W = GENİŞLİK = WIDTH / T = KALINLIK = THICKNESS



ARTIM METAL ELEKTRİK A.Ş.

100 AST 100-10D

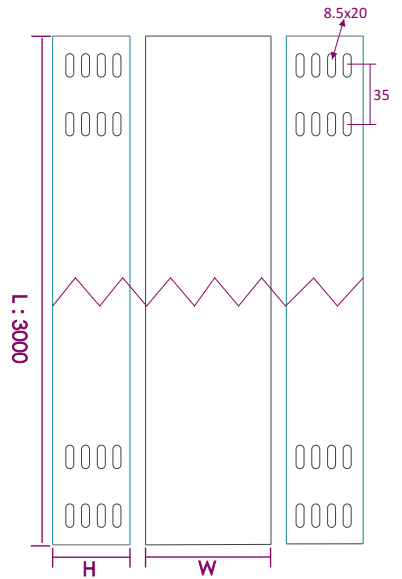
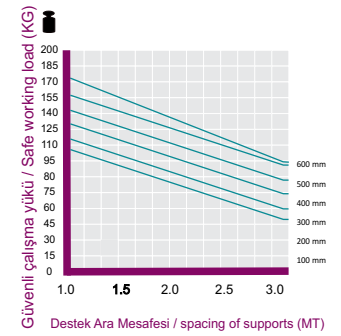

Standart uzunluk L:3000 mm
Toplu miktarlarda Özel ölçüler yapılabilir.
Standard Length L:3000 mm
Custom sizes can be made in bulk quantities.

* Farklı kalınlık ve ölçülerde üretim yapılabılır.
* Malzeme ağırlıkları yaklaşık değerlerdir, \pm %10 değişiklik gösterebilir.
* Malzeme kalınlık toleransı \pm %10 dur.
* Lütfen siparişlerinizde sipariş kodu veya ürün kodu ve Kaplama şeklini belirtiniz.

* We can produce cable trays different thickness and dimensions
* Cable trays are shown approximately weight, they could change \pm %10 difference.
* Cable trays thickness tolerances are shown \pm %10 .
* Please indicate order code and coating type in your orders.

H100 AST SERIES

STANDART TIP KABLO KANALLARI (DELİKSİZ)

MEDIUM DUTY CABLE TRAYS (NON PERFORATED)

SICAK DALDIRMA (SD)
HOT DIP GALVANIZED (SD)
TS EN ISO 1461

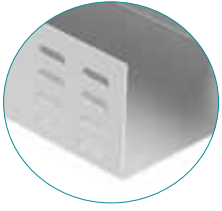

1.00 mm

Sipariş Kodu Order Code	W (mm)	T (mm)	Ağırlık (kg/m) Weight (kg/m)	Barkod Kodu Barcode Code
100 AST 100-10D	100	1.00 mm	2,616	2000193
100 AST 160-10D	160	1.00 mm	3,000	2000195
100 AST 200-10D	200	1.00 mm	3,378	2000196

1.20 mm

Sipariş Kodu Order Code	W (mm)	T (mm)	Ağırlık (kg/m) Weight (kg/m)	Barkod Kodu Barcode Code
100 AST 100-12D	100	1.20 mm	3,141	2000197
100 AST 160-12D	160	1.20 mm	3,601	2000199
100 AST 200-12D	200	1.20 mm	4,054	2000200
100 AST 300-12D	300	1.20 mm	4,961	2000201

1.50 mm

Sipariş Kodu Order Code	W (mm)	T (mm)	Ağırlık (kg/m) Weight (kg/m)	Barkod Kodu Barcode Code
100 AST 100-15D	100	1.50 mm	3,830	2000202
100 AST 160-15D	160	1.50 mm	4,201	2000204
100 AST 200-15D	200	1.50 mm	4,967	2000205
100 AST 300-15D	300	1.50 mm	6,105	2000206
100 AST 400-15D	400	1.50 mm	7,244	2000207
100 AST 500-15D	500	1.50 mm	8,382	2000208
100 AST 600-15D	600	1.50 mm	9,521	2000209

2.00 mm

Sipariş Kodu Order Code	W (mm)	T (mm)	Ağırlık (kg/m) Weight (kg/m)	Barkod Kodu Barcode Code
100 AST 100-20D	100	2.00 mm	5,196	2000210
100 AST 160-20D	160	2.00 mm	5,699	2000212
100 AST 200-20D	200	2.00 mm	6,740	2000213
100 AST 300-20D	300	2.00 mm	8,174	2000214
100 AST 400-20D	400	2.00 mm	9,696	2000215
100 AST 500-20D	500	2.00 mm	11,211	2000216
100 AST 600-20D	600	2.00 mm	12,721	2000217
100 AST 700-20D	700	2.00 mm	14,995	2000495
100 AST 800-20D	800	2.00 mm	16,636	2000496
100 AST 900-20D	900	2.00 mm	18,277	2000497

H = YÜKSEKLİK = HEIGHT / W = GENİŞLİK = WIDTH / T = KALINLIK = THICKNESS

100 AST 100-10D

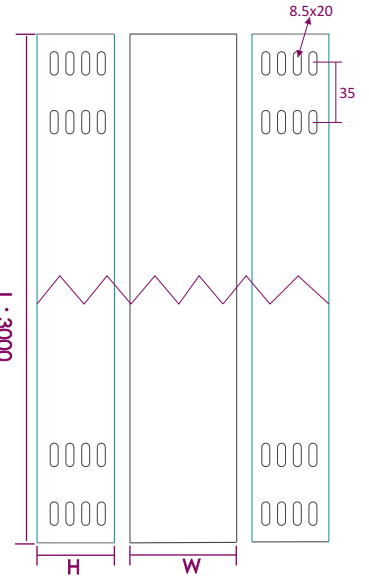
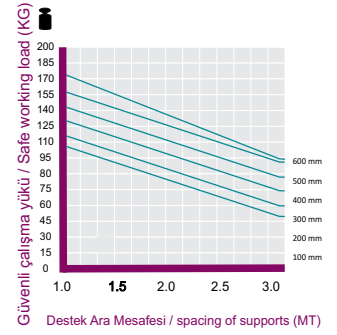

Standart uzunluk L:3000 mm
Toplu miktarlarda Özel ölçüler yapılabilir.
Standard Length L:3000 mm
Custom sizes can be made in bulk quantities.

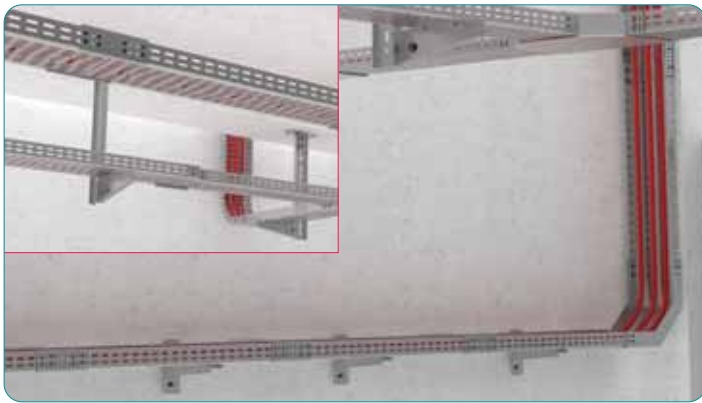

* Farklı kalınlık ve ölçülerde üretim yapılabılır.
* Malzeme ağırlıkları yaklaşık değerlerdir, \pm %10 değişiklik gösterebilir.
* Malzeme kalınlık toleransı \pm %10 dur.
* Lütfen siparişlerinizde sipariş kodu veya ürün kodu ve Kaplama şeklini belirtiniz.

* We can produce cable trays different thickness and dimensions
* Cable trays are shown approximately weight, they could change \pm %10 difference.
* Cable trays thickness tolerances are shown \pm %10 .
* Please indicate order code and coating type in your orders.

AGH SERIES

90° YATAY DÖNÜS (MODEL1)

90° BEND (MODEL1)

PREGALVANİZ (PG)
PREGALVANIZED (PG)
TS EN 10346



H40 = H50 Tek delikli
H40 = H50 One hole



H40

Sipariş Kodu Order Code	W (mm)	T (mm)	Ağırlık (kg/ad) Weight (kg/pcs)	Barkod Kodu Barcode Code
40 AGH 050Y	50	1.20 mm	0,198	2001100
40 AGH 100Y	100	1.20 mm	0,540	2001101
40 AGH 120Y	120	1.20 mm	0,684	2001102
40 AGH 160Y	160	1.20 mm	0,720	2001103
40 AGH 200Y	200	1.20 mm	1,080	2001104
40 AGH 300Y	300	1.20 mm	1,674	2001105
40 AGH 400Y	400	1.50 mm	3,362	2001106
40 AGH 500Y	500	1.50 mm	4,745	2001107
40 AGH 600Y	600	1.50 mm	6,376	2001108

H50

Sipariş Kodu Order Code	W (mm)	T (mm)	Ağırlık (kg/ad) Weight (kg/pcs)	Barkod Kodu Barcode Code
50 AGH 050Y	50	1.20 mm	0,230	2001109
50 AGH 100Y	100	1.20 mm	0,594	2001110
50 AGH 160Y	160	1.20 mm	0,785	2001111
50 AGH 200Y	200	1.20 mm	1,091	2001112
50 AGH 300Y	300	1.20 mm	1,764	2001113
50 AGH 400Y	400	1.50 mm	3,514	2001114
50 AGH 500Y	500	1.50 mm	4,921	2001115
50 AGH 600Y	600	1.50 mm	6,577	2001116

H60

Sipariş Kodu Order Code	W (mm)	T (mm)	Ağırlık (kg/ad) Weight (kg/pcs)	Barkod Kodu Barcode Code
60 AGH 100Y	100	1.20 mm	0,655	2001117
60 AGH 160Y	160	1.20 mm	0,850	2001118
60 AGH 200Y	200	1.20 mm	1,166	2001119
60 AGH 300Y	300	1.20 mm	1,868	2001120
60 AGH 400Y	400	1.50 mm	3,672	2001121
60 AGH 500Y	500	1.50 mm	5,393	2001122
60 AGH 600Y	600	1.50 mm	6,782	2001123

H100

Sipariş Kodu Order Code	W (mm)	T (mm)	Ağırlık (kg/ad) Weight (kg/pcs)	Barkod Kodu Barcode Code
100 AGH 100Y	100	1.20 mm	0,810	2001124
100 AGH 160Y	160	1.20 mm	1,087	2001125
100 AGH 200Y	200	1.20 mm	1,458	2001126
100 AGH 300Y	300	1.20 mm	2,232	2001127
100 AGH 400Y	400	1.50 mm	4,259	2001128
100 AGH 500Y	500	1.50 mm	5,789	2001129
100 AGH 600Y	600	1.50 mm	7,571	2001130

H = YÜKSEKLİK = HEIGHT / W = GENİŞLİK = WIDTH / T = KALINLIK = THICKNESS

H AGH 100 Y

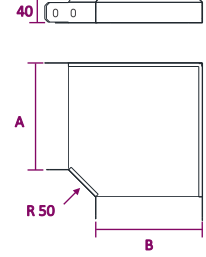

Dönüşlerde "A-B" ölçüleri esit olarak üretilmektedir. İsteğe bağlı olarak farklı ölçülerde üretim yapılır. Bends are produced same dimension for "A-B" as well as we can produce special dimensions regarding your inquiry.

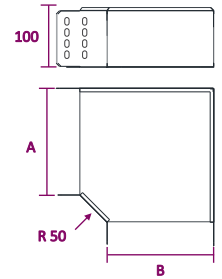
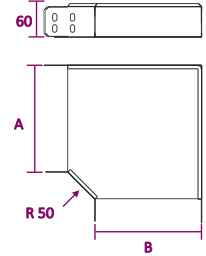

ARTIM METAL ELEKTRİK A.Ş.

- * Farklı kalınlık ve ölçülerde üretim yapılabılır.
- * Malzeme ağırlıkları yaklaşık değerlerdir, \pm %10 değişiklik gösterebilir.
- * Malzeme kalınlık toleransı \pm %10 dur.
- * Lütfen siparişlerinizde sipariş kodu veya ürün kodu ve Kaplama şeklini belirtiniz.

- * We can produce cable trays different thickness and dimensions
- * Cable trays are shown approximately weight, they could change \pm %10 difference.
- * Cable trays thickness tolerances are shown \pm %10 .
- * Please indicate order code and coating type in your orders.

AGH SERIES

90° YATAY DÖNÜS (MODEL1)

90° BEND (MODEL1)

SICAK DALDIRMA (SD)

HOT DIP GALVANIZED (HDG)

TS EN ISO 1461



H40 = H50 Tek delikli
H40 = H50 One hole



H50 = H60 İki delikli
H50 = H60 Two holes



H60 = H100 İki delikli
H60 = H100 Two holes



Sipariş Kodu Order Code	W (mm)	T (mm)	Ağırlık (kg/ad) Weight (kg/pcs)	Barkod Kodu Barcode Code
40 AGH 050Y	50	1.50 mm	0,270	2001100
40 AGH 100Y	100	1.50 mm	0,735	2001101
40 AGH 120Y	120	1.50 mm	0,857	2001102
40 AGH 160Y	160	1.50 mm	0,980	2001103
40 AGH 200Y	200	1.50 mm	1,372	2001104
40 AGH 300Y	300	1.50 mm	2,279	2001105
40 AGH 400Y	400	2.00 mm	4,577	2001106
40 AGH 500Y	500	2.00 mm	6,458	2001107
40 AGH 600Y	600	2.00 mm	8,678	2001108

Sipariş Kodu Order Code	W (mm)	T (mm)	Ağırlık (kg/ad) Weight (kg/pcs)	Barkod Kodu Barcode Code
50 AGH 050Y	50	1.50 mm	0,314	2001109
50 AGH 100Y	100	1.50 mm	0,809	2001110
50 AGH 160Y	160	1.50 mm	1,068	2001111
50 AGH 200Y	200	1.50 mm	1,485	2001112
50 AGH 300Y	300	1.50 mm	2,401	2001113
50 AGH 400Y	400	2.00 mm	4,782	2001114
50 AGH 500Y	500	2.00 mm	6,698	2001115
50 AGH 600Y	600	2.00 mm	8,952	2001116

Sipariş Kodu Order Code	W (mm)	T (mm)	Ağırlık (kg/ad) Weight (kg/pcs)	Barkod Kodu Barcode Code
60 AGH 100Y	100	1.50 mm	0,892	2001117
60 AGH 160Y	160	1.50 mm	1,156	2001118
60 AGH 200Y	200	1.50 mm	1,588	2001119
60 AGH 300Y	300	1.50 mm	2,543	2001120
60 AGH 400Y	400	2.00 mm	4,998	2001121
60 AGH 500Y	500	2.00 mm	7,340	2001122
60 AGH 600Y	600	2.00 mm	9,232	2001123

Sipariş Kodu Order Code	W (mm)	T (mm)	Ağırlık (kg/ad) Weight (kg/pcs)	Barkod Kodu Barcode Code
100 AGH 100Y	100	1.50 mm	1,103	2001124
100 AGH 160Y	160	1.50 mm	1,480	2001125
100 AGH 200Y	200	1.50 mm	1,985	2001126
100 AGH 300Y	300	1.50 mm	3,038	2001127
100 AGH 400Y	400	2.00 mm	5,797	2001128
100 AGH 500Y	500	2.00 mm	7,879	2001129
100 AGH 600Y	600	2.00 mm	10,305	2001130

H = YÜKSEKLİK = HEIGHT / W = GENİŞLİK = WIDTH / T = KALINLIK = THICKNESS

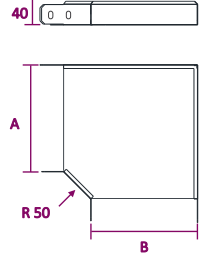
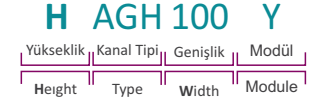

Dönüşlerde "A-B" ölçüleri esit olarak üretilmektedir. İsteğe bağlı olarak farklı ölçülerde üretim yapılır. Bends are produced same dimension for "A-B" as well as we can produce special dimensions regarding your inquiry.

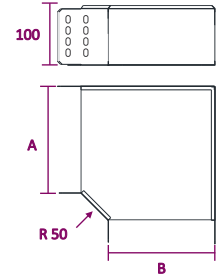
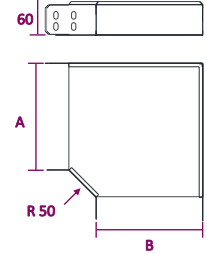

* Farklı kalınlık ve ölçülerde üretim yapılabılır.
* Malzeme ağırlıkları yaklaşık değerlerdir, ± %10 değişiklik gösterebilir.
* Malzeme kalınlık toleransı ± %10 dur.
* Lütfen siparişlerinizde sipariş kodu veya ürün kodu ve Kaplama şeklini belirtiniz.

* We can produce cable trays different thickness and dimensions
* Cable trays are shown approximately weight, they could change ± %10 difference.
* Cable trays thickness tolerances are shown ± %10 .
* Please indicate order code and coating type in your orders.

AGH SERIES

90° YATAY DÖNÜS (MODEL2)

90° BEND (MODEL2)

PREGALVANİZ (PG)
PREGALVANIZED (PG)
TS EN 10346



H40 = H50 = H60 Tek delikli
H40 = H50 = H60 One hole



Sipariş Kodu Order Code	W (mm)	T (mm)	Ağırlık (kg/ad) Weight (kg/pcs)	Barkod Kodu Barcode Code
40 AGH 050Y	50	1.20 mm	0,178	2001100
40 AGH 100Y	100	1.20 mm	0,486	2001101
40 AGH 120Y	120	1.20 mm	0,616	2001102
40 AGH 160Y	160	1.20 mm	0,648	2001103
40 AGH 200Y	200	1.20 mm	0,972	2001104
40 AGH 300Y	300	1.20 mm	1,440	2001105
40 AGH 400Y	400	1.50 mm	2,891	2001106
40 AGH 500Y	500	1.50 mm	4,081	2001107
40 AGH 600Y	600	1.50 mm	5,483	2001108

Sipariş Kodu Order Code	W (mm)	T (mm)	Ağırlık (kg/ad) Weight (kg/pcs)	Barkod Kodu Barcode Code
50 AGH 050Y	50	1.20 mm	0,207	2001109
50 AGH 100Y	100	1.20 mm	0,535	2001110
50 AGH 160Y	160	1.20 mm	0,707	2001111
50 AGH 200Y	200	1.20 mm	0,982	2001112
50 AGH 300Y	300	1.20 mm	1,517	2001113
50 AGH 400Y	400	1.50 mm	3,022	2001114
50 AGH 500Y	500	1.50 mm	4,232	2001115
50 AGH 600Y	600	1.50 mm	5,656	2001116

Sipariş Kodu Order Code	W (mm)	T (mm)	Ağırlık (kg/ad) Weight (kg/pcs)	Barkod Kodu Barcode Code
60 AGH 100Y	100	1.20 mm	0,590	2001117
60 AGH 160Y	160	1.20 mm	0,765	2001118
60 AGH 200Y	200	1.20 mm	1,049	2001119
60 AGH 300Y	300	1.20 mm	1,606	2001120
60 AGH 400Y	400	1.50 mm	3,158	2001121
60 AGH 500Y	500	1.50 mm	4,638	2001122
60 AGH 600Y	600	1.50 mm	5,833	2001123

H = YÜKSEKLİK = HEIGHT / W = GENİŞLİK = WIDTH / T = KALINLIK = THICKNESS

H AGH 100 Y

Yükseklik Kanal Tipi Genişlik Modül
Height Type Width Module

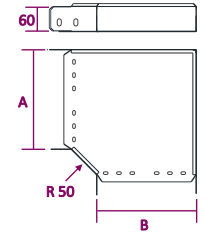
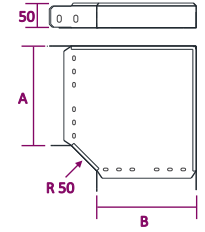
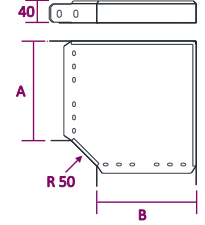

Dönüşlerde "A-B" ölçüleri eşit olarak üretilmektedir. İsteğe bağlı olarak farklı ölçülerde üretim yapılır. Bends are produced same dimension for "A-B" as well as we can produce special dimensions regarding your inquiry.

ARTIM METAL ELEKTRİK A.Ş.

- * Farklı kalınlık ve ölçülerde üretim yapılabılır.
- * Malzeme ağırlıkları yaklaşık değerlerdir, ± %10 değişiklik gösterebilir.
- * Malzeme kalınlık toleransı ± %10 dur.
- * Lütfen siparişlerinizde sipariş kodu veya ürün kodu ve Kaplama şeklini belirtiniz.

- * We can produce cable trays different thickness and dimensions
- * Cable trays are shown approximately weight, they could change ± %10 difference.
- * Cable trays thickness tolerances are shown ± %10 .
- * Please indicate order code and coating type in your orders.

AGH SERIES

90° YATAY DÖNÜŞ (MODEL2)

90° BEND (MODEL2)

SICAK DALDIRMA (SD)

HOT DIP GALVANIZED (HDG)

TS EN ISO 1461



H40 = H50 = H60 Tek delikli
H40 = H50 = H60 One hole



Sipariş Kodu Order Code	W (mm)	T (mm)	Ağırlık (kg/ad) Weight (kg/pcs)	Barkod Kodu Barcode Code
40 AGH 050Y	50	1.50 mm	0,243	2001100
40 AGH 100Y	100	1.50 mm	0,662	2001101
40 AGH 120Y	120	1.20 mm	0,717	2001102
40 AGH 160Y	160	1.50 mm	0,882	2001103
40 AGH 200Y	200	1.50 mm	1,235	2001104
40 AGH 300Y	300	1.50 mm	1,960	2001105
40 AGH 400Y	400	2.00 mm	3,936	2001106
40 AGH 500Y	500	2.00 mm	5,554	2001107
40 AGH 600Y	600	2.00 mm	7,463	2001108

Sipariş Kodu Order Code	W (mm)	T (mm)	Ağırlık (kg/ad) Weight (kg/pcs)	Barkod Kodu Barcode Code
50 AGH 050Y	50	1.50 mm	0,283	2001109
50 AGH 100Y	100	1.50 mm	0,728	2001110
50 AGH 160Y	160	1.50 mm	0,961	2001111
50 AGH 200Y	200	1.50 mm	1,337	2001112
50 AGH 300Y	300	1.50 mm	2,065	2001113
50 AGH 400Y	400	2.00 mm	4,113	2001114
50 AGH 500Y	500	2.00 mm	5,760	2001115
50 AGH 600Y	600	2.00 mm	7,699	2001116

Sipariş Kodu Order Code	W (mm)	T (mm)	Ağırlık (kg/ad) Weight (kg/pcs)	Barkod Kodu Barcode Code
60 AGH 100Y	100	1.50 mm	0,803	2001117
60 AGH 160Y	160	1.50 mm	1,040	2001118
60 AGH 200Y	200	1.50 mm	1,429	2001119
60 AGH 300Y	300	1.50 mm	2,187	2001120
60 AGH 400Y	400	2.00 mm	4,298	2001121
60 AGH 500Y	500	2.00 mm	6,312	2001122
60 AGH 600Y	600	2.00 mm	7,940	2001123

H = YÜKSEKLİK = HEIGHT / W = GENİŞLİK = WIDTH / T = KALINLIK = THICKNESS

H40

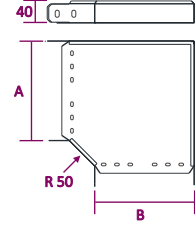
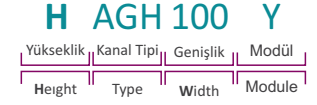

H50

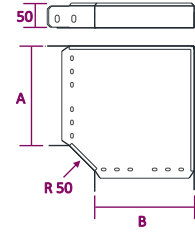

H60

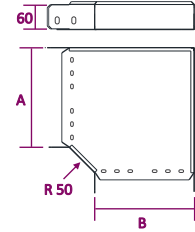

Dönüşlerde "A-B" ölçüleri esit olarak üretilmektedir. İsteğe bağlı olarak farklı ölçülerde üretim yapılır. Bends are produced same dimension for "A-B" as well as we can produce special dimensions regarding your inquiry.

* Farklı kalınlık ve ölçülerde üretim yapılabılır.
* Malzeme ağırlıkları yaklaşık değerlerdir, ± %10 değişiklik gösterebilir.
* Malzeme kalınlık toleransı ± %10 dur.
* Lütfen siparişlerinizde sipariş kodu veya ürün kodu ve Kaplama şeklini belirtiniz.

* We can produce cable trays different thickness and dimensions
* Cable trays are shown approximately weight, they could change ± %10 difference.
* Cable trays thickness tolerances are shown ± %10 .
* Please indicate order code and coating type in your orders.

AGH SERIES

T BAGLANTI (MODEL1)

T BEND (MODEL1)

PREGALVANIZ (PG)
PREGALVANIZED (PG)
TS EN 10346



H40 = H50 Tek delikli
H40 = H50 One hole



H40

Sipariş Kodu Order Code	W (mm)	T (mm)	Ağırlık (kg/ad) Weight (kg/pcs)	Barkod Kodu Barcode Code
40 AGH 050T	50	1.20 mm	0,263	2001200
40 AGH 100T	100	1.20 mm	0,644	2001201
40 AGH 120T	120	1.20 mm	0,790	2001202
40 AGH 160T	160	1.20 mm	1,122	2001203
40 AGH 200T	200	1.20 mm	1,116	2001204
40 AGH 300T	300	1.20 mm	1,782	2001205
40 AGH 400T	400	1.50 mm	4,666	2001206
40 AGH 500T	500	1.50 mm	4,882	2001207
40 AGH 600T	600	1.50 mm	6,509	2001208

H50

Sipariş Kodu Order Code	W (mm)	T (mm)	Ağırlık (kg/ad) Weight (kg/pcs)	Barkod Kodu Barcode Code
50 AGH 050T	50	1.20 mm	0,302	2001209
50 AGH 100T	100	1.20 mm	0,716	2001210
50 AGH 160T	160	1.20 mm	0,893	2001211
50 AGH 200T	200	1.20 mm	1,202	2001212
50 AGH 300T	300	1.20 mm	1,872	2001213
50 AGH 400T	400	1.50 mm	3,629	2001214
50 AGH 500T	500	1.50 mm	5,022	2001215
50 AGH 600T	600	1.50 mm	6,664	2001216

H60

Sipariş Kodu Order Code	W (mm)	T (mm)	Ağırlık (kg/ad) Weight (kg/pcs)	Barkod Kodu Barcode Code
60 AGH 100T	100	1.20 mm	0,785	2001217
60 AGH 160T	160	1.20 mm	0,961	2001218
60 AGH 200T	200	1.20 mm	1,278	2001219
60 AGH 300T	300	1.20 mm	1,958	2001220
60 AGH 400T	400	1.50 mm	3,766	2001221
60 AGH 500T	500	1.50 mm	5,166	2001222
60 AGH 600T	600	1.50 mm	6,818	2001223

H100

Sipariş Kodu Order Code	W (mm)	T (mm)	Ağırlık (kg/ad) Weight (kg/pcs)	Barkod Kodu Barcode Code
100 AGH 100T	100	1.20 mm	1,026	2001224
100 AGH 160T	160	1.20 mm	1,202	2001225
100 AGH 200T	200	1.20 mm	1,559	2001226
100 AGH 300T	300	1.20 mm	2,275	2001227
100 AGH 400T	400	1.50 mm	4,234	2001228
100 AGH 500T	500	1.50 mm	5,688	2001229
100 AGH 600T	600	1.50 mm	7,394	2001230

H = YÜKSEKLİK = HEIGHT / W = GENİŞLİK = WIDTH / T = KALINLIK = THICKNESS

H AGH 100 T

Yükseklik Kanal Tipi Genişlik Modül
Height Type Width Module

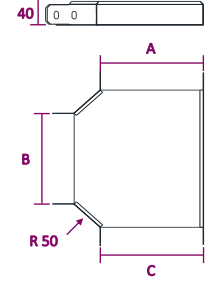

Dönüşlerde "A-B-C" ölçüleri esit olarak üretilmektedir. İsteğe bağlı olarak farklı ölçülerde üretim yapılır. Bends are produced same dimension for "A-B-C" as well as we can produce special dimensions regarding your inquiry.

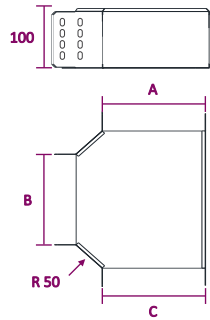
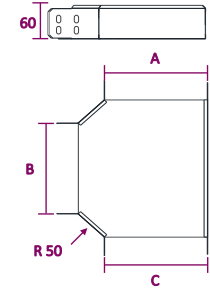

ARTIM METAL ELEKTRİK A.Ş.

* Farklı kalınlık ve ölçülerde üretim yapılabılır.
* Malzeme ağırlıkları yaklaşık değerlerdir, \pm %10 değişiklik gösterebilir.
* Malzeme kalınlık toleransı \pm %10 dur.
* Lütfen siparişlerinizde sipariş kodu veya ürün kodu ve Kaplama şeklini belirtiniz.

* We can produce cable trays different thickness and dimensions
* Cable trays are shown approximately weight, they could change \pm %10 difference.
* Cable trays thickness tolerances are shown \pm %10 .
* Please indicate order code and coating type in your orders.

AGH SERIES

T BAGLANTI (MODEL1)

T BEND (MODEL1)

SICAK DALDIRMA (SD)

HOT DIP GALVANIZED (HDG)

TS EN ISO 1461



H40 = H50 Tek delikli
H40 = H50 One hole



H40

Sipariş Kodu Order Code	W (mm)	T (mm)	Ağırlık (kg/ad) Weight (kg/pcs)	Barkod Kodu Barcode Code
40 AGH 050T	50	1.50 mm	0,358	2001200
40 AGH 100T	100	1.50 mm	0,877	2001201
40 AGH 120T	120	1.50 mm	1,000	2001202
40 AGH 160T	160	1.50 mm	1,122	2001203
40 AGH 200T	200	1.50 mm	1,519	2001204
40 AGH 300T	300	1.50 mm	2,426	2001205
40 AGH 400T	400	2.00 mm	6,350	2001206
40 AGH 500T	500	2.00 mm	6,644	2001207
40 AGH 600T	600	2.00 mm	8,859	2001208

H50

Sipariş Kodu Order Code	W (mm)	T (mm)	Ağırlık (kg/ad) Weight (kg/pcs)	Barkod Kodu Barcode Code
50 AGH 050T	50	1.50 mm	0,412	2001209
50 AGH 100T	100	1.50 mm	0,975	2001210
50 AGH 160T	160	1.50 mm	1,215	2001211
50 AGH 200T	200	1.50 mm	1,637	2001212
50 AGH 300T	300	1.50 mm	2,548	2001213
50 AGH 400T	400	2.00 mm	4,939	2001214
50 AGH 500T	500	2.00 mm	6,836	2001215
50 AGH 600T	600	2.00 mm	9,070	2001216

H60

Sipariş Kodu Order Code	W (mm)	T (mm)	Ağırlık (kg/ad) Weight (kg/pcs)	Barkod Kodu Barcode Code
60 AGH 100T	100	1.50 mm	1,068	2001217
60 AGH 160T	160	1.50 mm	1,308	2001218
60 AGH 200T	200	1.50 mm	1,740	2001219
60 AGH 300T	300	1.50 mm	2,666	2001220
60 AGH 400T	400	2.00 mm	5,125	2001221
60 AGH 500T	500	2.00 mm	7,032	2001222
60 AGH 600T	600	2.00 mm	9,281	2001223

H100

Sipariş Kodu Order Code	W (mm)	T (mm)	Ağırlık (kg/ad) Weight (kg/pcs)	Barkod Kodu Barcode Code
100 AGH 100T	100	1.50 mm	1,397	2001224
100 AGH 160T	160	1.50 mm	1,637	2001225
100 AGH 200T	200	1.50 mm	2,122	2001226
100 AGH 300T	300	1.50 mm	3,097	2001227
100 AGH 400T	400	2.00 mm	5,762	2001228
100 AGH 500T	500	2.00 mm	7,742	2001229
100 AGH 600T	600	2.00 mm	10,065	2001230

H = YÜKSEKLİK = HEIGHT / W = GENİŞLİK = WIDTH / T = KALINLIK = THICKNESS

H AGH 100 T

Yükseklik Kanal Tipi Genişlik Modül
Height Type Width Module

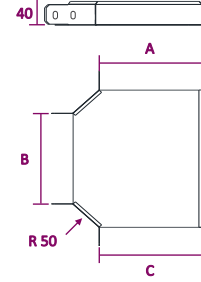

Dönüşlerde "A-B-C" ölçüleri esit olarak üretilmektedir. İsteğe bağlı olarak farklı ölçülerde üretim yapılır.
Bends are produced same dimension for "A-B-C" as well as we can produce special dimensions regarding your inquiry.

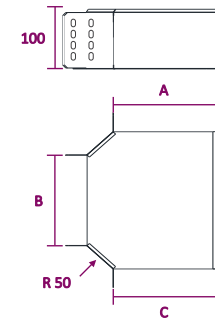
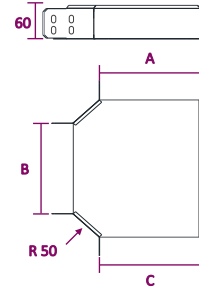

* Farklı kalınlık ve ölçülerde üretim yapılabılır.
* Malzeme ağırlıkları yaklaşık değerlerdir, ± %10 değişiklik gösterebilir.
* Malzeme kalınlık toleransı ± %10 dur.
* Lütfen siparişlerinizde sipariş kodu veya ürün kodu ve kaplama şeklini belirtiniz.

* We can produce cable trays different thickness and dimensions
* Cable trays are shown approximately weight, they could change ± %10 difference.
* Cable trays thickness tolerances are shown ± %10 .
* Please indicate order code and coating type in your orders.

AGH SERIES

T BAGLANTI (MODEL2)

T BEND (MODEL2)

PREGALVANIZ (PG)
PREGALVANIZED (PG)
TS EN 10346



H40 = H50 = H60 Tek delikli
H40 = H50 = H60 One hole



H40

Sipariş Kodu Order Code	W (mm)	T (mm)	Ağırlık (kg/ad) Weight (kg/pcs)	Barkod Kodu Barcode Code
40 AGH 050T	50	1.20 mm	0,237	2001200
40 AGH 100T	100	1.20 mm	0,580	2001201
40 AGH 120T	120	1.20 mm	0,711	2001202
40 AGH 160T	160	1.20 mm	1,010	2001203
40 AGH 200T	200	1.20 mm	1,004	2001204
40 AGH 300T	300	1.20 mm	1,604	2001205
40 AGH 400T	400	1.50 mm	4,199	2001206
40 AGH 500T	500	1.50 mm	4,394	2001207
40 AGH 600T	600	1.50 mm	5,858	2001208

H50

Sipariş Kodu Order Code	W (mm)	T (mm)	Ağırlık (kg/ad) Weight (kg/pcs)	Barkod Kodu Barcode Code
50 AGH 050T	50	1.20 mm	0,272	2001209
50 AGH 100T	100	1.20 mm	0,644	2001210
50 AGH 160T	160	1.20 mm	0,804	2001211
50 AGH 200T	200	1.20 mm	1,082	2001212
50 AGH 300T	300	1.20 mm	1,685	2001213
50 AGH 400T	400	1.50 mm	3,266	2001214
50 AGH 500T	500	1.50 mm	4,520	2001215
50 AGH 600T	600	1.50 mm	5,998	2001216

H60

Sipariş Kodu Order Code	W (mm)	T (mm)	Ağırlık (kg/ad) Weight (kg/pcs)	Barkod Kodu Barcode Code
60 AGH 100T	100	1.20 mm	0,707	2001217
60 AGH 160T	160	1.20 mm	0,865	2001218
60 AGH 200T	200	1.20 mm	1,150	2001219
60 AGH 300T	300	1.20 mm	1,762	2001220
60 AGH 400T	400	1.50 mm	3,389	2001221
60 AGH 500T	500	1.50 mm	4,649	2001222
60 AGH 600T	600	1.50 mm	6,136	2001223

H = YÜKSEKLİK = HEIGHT / W = GENİŞLİK = WIDTH / T = KALINLIK = THICKNESS

H AGH 100 T

Yükseklik Kanal Tipi Genişlik Modül
Height Type Width Module

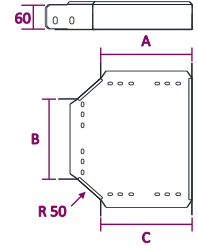
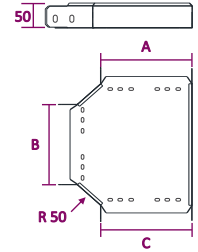
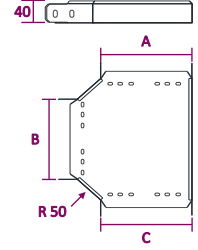

Dönüşlerde "A-B-C" ölçüleri esit olarak üretilmektedir. İsteğe bağlı olarak farklı ölçülerde üretim yapılır. Bends are produced same dimension for "A-B-C" as well as we can produce special dimensions regarding your inquiry.

ARTIM METAL ELEKTRİK A.Ş.

- * Farklı kalınlık ve ölçülerde üretim yapılabılır.
- * Malzeme ağırlıkları yaklaşık değerlerdir, ± %10 değişiklik gösterebilir.
- * Malzeme kalınlık toleransı ± %10 dur.
- * Lütfen siparişlerinizde sipariş kodu veya ürün kodu ve Kaplama şeklini belirtiniz.

- * We can produce cable trays different thickness and dimensions
- * Cable trays are shown approximately weight, they could change ± %10 difference.
- * Cable trays thickness tolerances are shown ± %10 .
- * Please indicate order code and coating type in your orders.

AGH SERIES

T BAGLANTI (MODEL2)

T BEND (MODEL2)

SICAK DALDIRMA (SD)

HOT DIP GALVANIZED (HDG)

TS EN ISO 1461



H40 = H50 = H60 Tek delikli
H40 = H50 = H60 One hole



H40

Sipariş Kodu Order Code	W (mm)	T (mm)	Ağırlık (kg/ad) Weight (kg/pcs)	Barkod Kodu Barcode Code
40 AGH 050T	50	1.50 mm	0,322	2001200
40 AGH 100T	100	1.50 mm	0,789	2001201
40 AGH 120T	120	1.50 mm	0,900	2001202
40 AGH 160T	160	1.50 mm	1,010	2001203
40 AGH 200T	200	1.50 mm	1,367	2001204
40 AGH 300T	300	1.50 mm	2,183	2001205
40 AGH 400T	400	2.00 mm	5,715	2001206
40 AGH 500T	500	2.00 mm	5,980	2001207
40 AGH 600T	600	2.00 mm	7,973	2001208

H50

Sipariş Kodu Order Code	W (mm)	T (mm)	Ağırlık (kg/ad) Weight (kg/pcs)	Barkod Kodu Barcode Code
50 AGH 050T	50	1.50 mm	0,371	2001209
50 AGH 100T	100	1.50 mm	0,878	2001210
50 AGH 160T	160	1.50 mm	1,094	2001211
50 AGH 200T	200	1.50 mm	1,473	2001212
50 AGH 300T	300	1.50 mm	2,293	2001213
50 AGH 400T	400	2.00 mm	4,445	2001214
50 AGH 500T	500	2.00 mm	6,152	2001215
50 AGH 600T	600	2.00 mm	8,163	2001216

H60

Sipariş Kodu Order Code	W (mm)	T (mm)	Ağırlık (kg/ad) Weight (kg/pcs)	Barkod Kodu Barcode Code
60 AGH 100T	100	1.50 mm	0,961	2001217
60 AGH 160T	160	1.50 mm	1,177	2001218
60 AGH 200T	200	1.50 mm	1,566	2001219
60 AGH 300T	300	1.50 mm	2,399	2001220
60 AGH 400T	400	2.00 mm	4,613	2001221
60 AGH 500T	500	2.00 mm	6,329	2001222
60 AGH 600T	600	2.00 mm	8,353	2001223

H = YÜKSEKLİK = HEIGHT / W = GENİŞLİK = WIDTH / T = KALINLIK = THICKNESS

H AGH 100 T

Yükseklik Kanal Tipi Genişlik Modül
Height Type Width Module

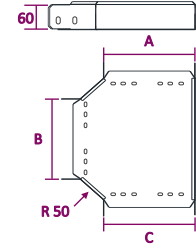
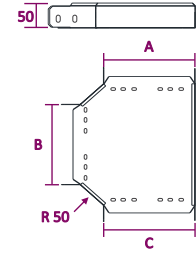
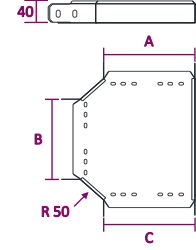

Dönüşlerde "A-B-C" ölçüleri esit olarak üretilmektedir. İsteğe bağlı olarak farklı ölçülerde üretim yapılır. Bends are produced same dimension for "A-B-C" as well as we can produce special dimensions regarding your inquiry.

* Farklı kalınlık ve ölçülerde üretim yapılabılır.
* Malzeme ağırlıkları yaklaşık değerlerdir, ± %10 değişiklik gösterebilir.
* Malzeme kalınlık toleransı ± %10 dur.
* Lütfen siparişlerinizde sipariş kodu veya ürün kodu ve Kaplama şeklini belirtiniz.

* We can produce cable trays different thickness and dimensions
* Cable trays are shown approximately weight, they could change ± %10 difference.
* Cable trays thickness tolerances are shown ± %10 .
* Please indicate order code and coating type in your orders.

AGH SERIES

DÖRTLÜ BAGLANTI (MODEL1)

FOUR WAY CROSSING (MODEL1)

PREGALVANİZ (PG)
PREGALVANİZED (PG)
TS EN 10346



H40 = H50 Tek delikli
H40 = H50 One hole



H40

Sipariş Kodu Order Code	W (mm)	T (mm)	Ağırlık (kg/ad) Weight (kg/pcs)	Barkod Kodu Barcode Code
40 AGH 050D	50	1.20 mm	0,302	2001300
40 AGH 100D	100	1.20 mm	0,752	2001301
40 AGH 120D	120	1.20 mm	0,903	2001302
40 AGH 160D	160	1.20 mm	0,922	2001303
40 AGH 200D	200	1.20 mm	1,224	2001304
40 AGH 300D	300	1.20 mm	1,886	2001305
40 AGH 400D	400	1.50 mm	3,640	2001306
40 AGH 500D	500	1.50 mm	5,011	2001307
40 AGH 600D	600	1.50 mm	6,638	2001308

H50

Sipariş Kodu Order Code	W (mm)	T (mm)	Ağırlık (kg/ad) Weight (kg/pcs)	Barkod Kodu Barcode Code
50 AGH 050D	50	1.20 mm	0,342	2001309
50 AGH 100D	100	1.20 mm	0,828	2001310
50 AGH 160D	160	1.20 mm	0,909	2001311
50 AGH 200D	200	1.20 mm	1,303	2001312
50 AGH 300D	300	1.20 mm	1,962	2001313
50 AGH 400D	400	1.50 mm	3,737	2001314
50 AGH 500D	500	1.50 mm	5,119	2001315
50 AGH 600D	600	1.50 mm	6,739	2001316

H60

Sipariş Kodu Order Code	W (mm)	T (mm)	Ağırlık (kg/ad) Weight (kg/pcs)	Barkod Kodu Barcode Code
60 AGH 100D	100	1.20 mm	0,900	2001317
60 AGH 160D	160	1.20 mm	1,058	2001318
60 AGH 200D	200	1.20 mm	1,379	2001319
60 AGH 300D	300	1.20 mm	2,034	2001320
60 AGH 400D	400	1.50 mm	3,841	2001321
60 AGH 500D	500	1.50 mm	5,220	2001322
60 AGH 600D	600	1.50 mm	6,840	2001323

H100

Sipariş Kodu Order Code	W (mm)	T (mm)	Ağırlık (kg/ad) Weight (kg/pcs)	Barkod Kodu Barcode Code
100 AGH 100D	100	1.20 mm	1,163	2001324
100 AGH 160D	160	1.20 mm	1,296	2001325
100 AGH 200D	200	1.20 mm	1,634	2001326
100 AGH 300D	300	1.20 mm	2,297	2001327
100 AGH 400D	400	1.50 mm	4,183	2001328
100 AGH 500D	500	1.50 mm	5,558	2001329
100 AGH 600D	600	1.50 mm	7,186	2001330

H = YÜKSEKLİK = HEIGHT / W = GENİŞLİK = WIDTH / T = KALINLIK = THICKNESS

H AGH 100 D

Yükseklik Kanal Tipi Genişlik Modül
Height Type Width Module

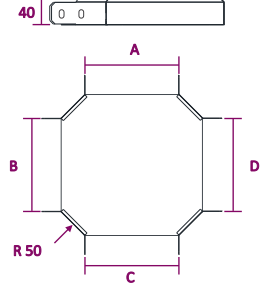

Dönüşlerde "A-B-C-D" ölçüleri esit olarak üretilmektedir. İsteğe bağlı olarak farklı ölçülerde üretim yapılır. Bends are produced same dimension for "A-B-C-D" as well as we can produce special dimensions regarding your inquiry.

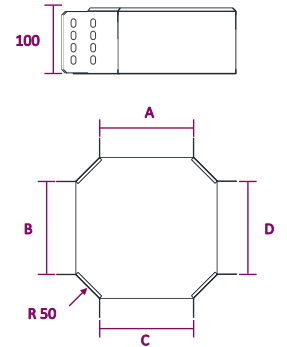
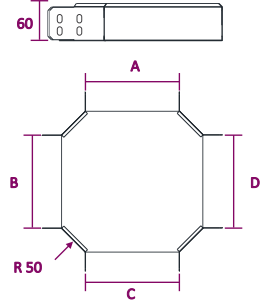

ARTIM METAL ELEKTRİK A.Ş.

* Farklı kalınlık ve ölçülerde üretim yapılabılır.
* Malzeme ağırlıkları yaklaşık değerlerdir, ± %10 değişiklik gösterebilir.
* Malzeme kalınlık toleransı ± %10 dur.
* Lütfen siparişlerinizde sipariş kodu veya ürün kodu ve Kaplama şeklini belirtiniz.

* We can produce cable trays different thickness and dimensions
* Cable trays are shown approximately weight, they could change ± %10 difference.
* Cable trays thickness tolerances are shown ± %10 .
* Please indicate order code and coating type in your orders.

AGH SERIES

DÖRTLÜ BAGLANTI (MODEL1)

FOUR WAY CROSSING (MODEL1)

SICAK DALDIRMA (SD)

HOT DIP GALVANIZED (SD)

TS EN ISO 1461



H40 = H50 Tek delikli
H40 = H50 One hole



H40

Sipariş Kodu Order Code	W (mm)	T (mm)	Ağırlık (kg/ad) Weight (kg/pcs)	Barkod Kodu Barcode Code
40 AGH 050D	50	1.50 mm	0,412	2001300
40 AGH 100D	100	1.50 mm	1,024	2001301
40 AGH 120D	120	1.50 mm	1,139	2001302
40 AGH 160D	160	1.50 mm	1,254	2001303
40 AGH 200D	200	1.50 mm	1,666	2001304
40 AGH 300D	300	1.50 mm	2,568	2001305
40 AGH 400D	400	2.00 mm	4,954	2001306
40 AGH 500D	500	2.00 mm	6,821	2001307
40 AGH 600D	600	2.00 mm	9,036	2001308

H50

Sipariş Kodu Order Code	W (mm)	T (mm)	Ağırlık (kg/ad) Weight (kg/pcs)	Barkod Kodu Barcode Code
50 AGH 050D	50	1.50 mm	0,466	2001309
50 AGH 100D	100	1.50 mm	1,127	2001310
50 AGH 160D	160	1.50 mm	1,348	2001311
50 AGH 200D	200	1.50 mm	1,774	2001312
50 AGH 300D	300	1.50 mm	2,671	2001313
50 AGH 400D	400	2.00 mm	5,086	2001314
50 AGH 500D	500	2.00 mm	6,968	2001315
50 AGH 600D	600	2.00 mm	9,173	2001316

H60

Sipariş Kodu Order Code	W (mm)	T (mm)	Ağırlık (kg/ad) Weight (kg/pcs)	Barkod Kodu Barcode Code
60 AGH 100D	100	1.50 mm	1,225	2001317
60 AGH 160D	160	1.50 mm	1,441	2001318
60 AGH 200D	200	1.50 mm	1,877	2001319
60 AGH 300D	300	1.50 mm	2,769	2001320
60 AGH 400D	400	2.00 mm	5,228	2001321
60 AGH 500D	500	2.00 mm	7,105	2001322
60 AGH 600D	600	2.00 mm	9,310	2001323

H100

Sipariş Kodu Order Code	W (mm)	T (mm)	Ağırlık (kg/ad) Weight (kg/pcs)	Barkod Kodu Barcode Code
100 AGH 100D	100	1.50 mm	1,583	2001324
100 AGH 160D	160	1.50 mm	1,764	2001325
100 AGH 200D	200	1.50 mm	2,225	2001326
100 AGH 300D	300	1.50 mm	3,126	2001327
100 AGH 400D	400	2.00 mm	5,694	2001328
100 AGH 500D	500	2.00 mm	7,566	2001329
100 AGH 600D	600	2.00 mm	9,780	2001330

H = YÜKSEKLİK = HEIGHT / W = GENİŞLİK = WIDTH / T = KALINLIK = THICKNESS

H AGH 100 D

Yükseklik Kanal Tipi Genişlik Modül
Height Type Width Module

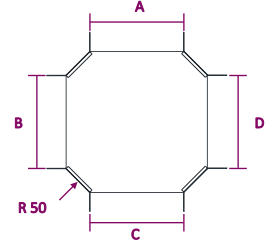

Dönüşlerde "A-B-C-D" ölçüleri esit olarak üretilmektedir. İsteğe bağlı olarak farklı ölçülerde üretim yapılır. Bends are produced same dimension for "A-B-C-D" as well as we can produce special dimensions regarding your inquiry.

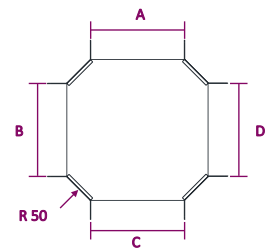
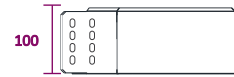
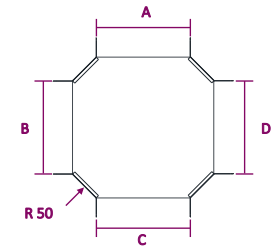

* Farklı kalınlık ve ölçülerde üretim yapılabılır.
* Malzeme ağırlıkları yaklaşık değerlerdir, \pm %10 değişiklik gösterebilir.
* Malzeme kalınlık toleransı \pm %10 dur.
* Lütfen siparişlerinizde sipariş kodu veya ürün kodu ve kaplama şeklini belirtiniz.

* We can produce cable trays different thickness and dimensions
* Cable trays are shown approximately weight, they could change \pm %10 difference.
* Cable trays thickness tolerances are shown \pm %10 .
* Please indicate order code and coating type in your orders.

AGH SERIES

DÖRTLÜ BAGLANTI (MODEL2)

FOUR WAY CROSSING (MODEL2)

PREGALVANIZ (PG)
PREGALVANIZED (PG)
TS EN 10346



H40 = H50 = H60 Tek delikli
H40 = H50 = H60 One hole



H40				
Sipariş Kodu Order Code	W (mm)	T (mm)	Ağırlık (kg/ad) Weight (kg/pcs)	Barkod Kodu Barcode Code
40 AGH 050D	50	1.20 mm	0,272	2001300
40 AGH 100D	100	1.20 mm	0,677	2001301
40 AGH 120D	120	1.20 mm	0,813	2001302
40 AGH 160D	160	1.20 mm	0,830	2001303
40 AGH 200D	200	1.20 mm	1,102	2001304
40 AGH 300D	300	1.20 mm	1,697	2001305
40 AGH 400D	400	1.50 mm	3,276	2001306
40 AGH 500D	500	1.50 mm	4,510	2001307
40 AGH 600D	600	1.50 mm	5,974	2001308

H50				
Sipariş Kodu Order Code	W (mm)	T (mm)	Ağırlık (kg/ad) Weight (kg/pcs)	Barkod Kodu Barcode Code
50 AGH 050D	50	1.20 mm	0,308	2001309
50 AGH 100D	100	1.20 mm	0,745	2001310
50 AGH 160D	160	1.20 mm	0,818	2001311
50 AGH 200D	200	1.20 mm	1,173	2001312
50 AGH 300D	300	1.20 mm	1,766	2001313
50 AGH 400D	400	1.50 mm	3,363	2001314
50 AGH 500D	500	1.50 mm	4,607	2001315
50 AGH 600D	600	1.50 mm	6,065	2001316

H60				
Sipariş Kodu Order Code	W (mm)	T (mm)	Ağırlık (kg/ad) Weight (kg/pcs)	Barkod Kodu Barcode Code
60 AGH 100D	100	1.20 mm	0,810	2001317
60 AGH 160D	160	1.20 mm	0,952	2001318
60 AGH 200D	200	1.20 mm	1,241	2001319
60 AGH 300D	300	1.20 mm	1,831	2001320
60 AGH 400D	400	1.50 mm	3,457	2001321
60 AGH 500D	500	1.50 mm	4,698	2001322
60 AGH 600D	600	1.50 mm	6,156	2001323

H = YÜKSEKLİK = HEIGHT / W = GENİŞLİK = WIDTH / T = KALINLIK = THICKNESS

H AGH 100 D
Yükseklik Kanal Tipi Genişlik Modül
Height Type Width Module

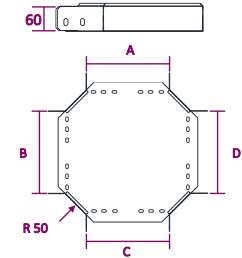
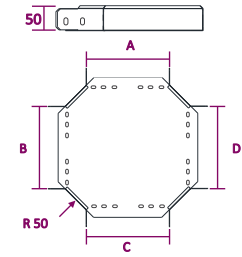
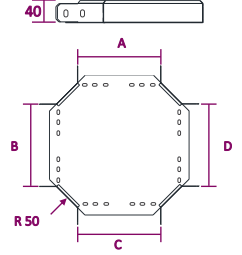

Dönüşlerde "A-B-C-D" ölçüleri esit olarak üretilmektedir. İsteğe bağlı olarak farklı ölçülerde üretim yapılır. Bends are produced same dimension for "A-B-C-D" as well as we can produce special dimensions regarding your inquiry.

ARTIM METAL ELEKTRİK A.Ş.

* Farklı kalınlık ve ölçülerde üretim yapılabılır.
* Malzeme ağırlıkları yaklaşık değerlerdir, \pm %10 değişiklik gösterebilir.
* Malzeme kalınlık toleransı \pm %10 dur.
* Lütfen siparişlerinizde sipariş kodu veya ürün kodu ve Kaplama şeklini belirtiniz.

* We can produce cable trays different thickness and dimensions
* Cable trays are shown approximately weight, they could change \pm %10 difference.
* Cable trays thickness tolerances are shown \pm %10 .
* Please indicate order code and coating type in your orders.

AGH SERIES

DÖRTLÜ BAGLANTI (MODEL2)

FOUR WAY CROSSING (MODEL2)

SICAK DALDIRMA (SD)

HOT DIP GALVANIZED (SD)

TS EN ISO 1461



Sipariş Kodu Order Code	W (mm)	T (mm)	Ağırlık (kg/ad) Weight (kg/pcs)	Barkod Kodu Barcode Code
40 AGH 050D	50	1.50 mm	0,371	2001300
40 AGH 100D	100	1.50 mm	0,922	2001301
40 AGH 120D	120	1.50 mm	1,025	2001302
40 AGH 160D	160	1.50 mm	1,129	2001303
40 AGH 200D	200	1.50 mm	1,499	2001304
40 AGH 300D	300	1.50 mm	2,311	2001305
40 AGH 400D	400	2.00 mm	4,459	2001306
40 AGH 500D	500	2.00 mm	6,139	2001307
40 AGH 600D	600	2.00 mm	8,132	2001308

H40

H AGH 100 D

Yükseklik Kanal Tipi Genişlik Modül
Height Type Width Module

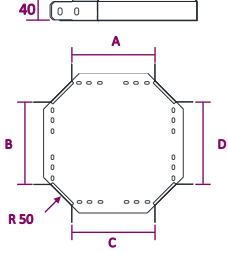

Sipariş Kodu Order Code	W (mm)	T (mm)	Ağırlık (kg/ad) Weight (kg/pcs)	Barkod Kodu Barcode Code
50 AGH 050D	50	1.50 mm	0,419	2001309
50 AGH 100D	100	1.50 mm	1,014	2001310
50 AGH 160D	160	1.50 mm	1,213	2001311
50 AGH 200D	200	1.50 mm	1,597	2001312
50 AGH 300D	300	1.50 mm	2,404	2001313
50 AGH 400D	400	2.00 mm	4,577	2001314
50 AGH 500D	500	2.00 mm	6,271	2001315
50 AGH 600D	600	2.00 mm	8,256	2001316

H50

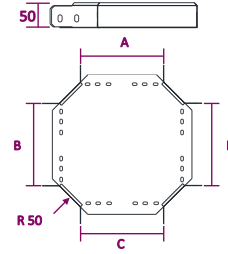

Sipariş Kodu Order Code	W (mm)	T (mm)	Ağırlık (kg/ad) Weight (kg/pcs)	Barkod Kodu Barcode Code
60 AGH 100D	100	1.50 mm	1,103	2001317
60 AGH 160D	160	1.50 mm	1,297	2001318
60 AGH 200D	200	1.50 mm	1,689	2001319
60 AGH 300D	300	1.50 mm	2,492	2001320
60 AGH 400D	400	2.00 mm	4,705	2001321
60 AGH 500D	500	2.00 mm	6,395	2001322
60 AGH 600D	600	2.00 mm	8,379	2001323

H60

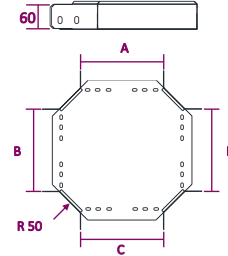

H = YÜKSEKLİK = HEIGHT / W = GENİŞLİK = WIDTH / T = KALINLIK = THICKNESS

Dönüşlerde "A-B-C-D" ölçüleri esit olarak üretilmektedir. İsteğe bağlı olarak farklı ölçülerde üretim yapılır. Bends are produced same dimension for "A-B-C-D" as well as we can produce special dimensions regarding your inquiry.



H40 = H50 = H60 Tek delikli
H40 = H50 = H60 One hole

* Farklı kalınlık ve ölçülerde üretim yapılabılır.
* Malzeme ağırlıkları yaklaşık değerlerdir, ± %10 değişiklik gösterebilir.
* Malzeme kalınlık toleransı ± %10 dur.
* Lütfen siparişlerinizde sipariş kodu veya ürün kodu ve Kaplama şeklini belirtiniz.

* We can produce cable trays different thickness and dimensions
* Cable trays are shown approximately weight, they could change ± %10 difference.
* Cable trays thickness tolerances are shown ± %10 .
* Please indicate order code and coating type in your orders.

AGH SERIES

90° YATAY DÖNÜS R300 (MODEL1)

90° BEND R300 (MODEL1)

PREGALVANIZ (PG)
PREGALVANIZED (PG)
TS EN 10346



H40 = H50 Tek delikli
H40 = H50 One hole



H40

Sipariş Kodu Order Code	W (mm)	T (mm)	Ağırlık (kg/ad) Weight (kg/pcs)	Barkod Kodu Barcode Code
40 AGH 050Y	50	1.20 mm	0,214	2001100
40 AGH 100Y	100	1.20 mm	0,583	2001101
40 AGH 120Y	120	1.20 mm	0,739	2001102
40 AGH 160Y	160	1.20 mm	0,778	2001103
40 AGH 200Y	200	1.20 mm	1,166	2001104
40 AGH 300Y	300	1.20 mm	1,808	2001105
40 AGH 400Y	400	1.50 mm	3,631	2001106
40 AGH 500Y	500	1.50 mm	5,125	2001107
40 AGH 600Y	600	1.50 mm	6,886	2001108

H50

Sipariş Kodu Order Code	W (mm)	T (mm)	Ağırlık (kg/ad) Weight (kg/pcs)	Barkod Kodu Barcode Code
50 AGH 050Y	50	1.20 mm	0,248	2001109
50 AGH 100Y	100	1.20 mm	0,642	2001110
50 AGH 160Y	160	1.20 mm	0,848	2001111
50 AGH 200Y	200	1.20 mm	1,178	2001112
50 AGH 300Y	300	1.20 mm	1,905	2001113
50 AGH 400Y	400	1.50 mm	3,795	2001114
50 AGH 500Y	500	1.50 mm	5,315	2001115
50 AGH 600Y	600	1.50 mm	7,103	2001116

H60

Sipariş Kodu Order Code	W (mm)	T (mm)	Ağırlık (kg/ad) Weight (kg/pcs)	Barkod Kodu Barcode Code
60 AGH 100Y	100	1.20 mm	0,707	2001117
60 AGH 160Y	160	1.20 mm	0,918	2001118
60 AGH 200Y	200	1.20 mm	1,259	2001119
60 AGH 300Y	300	1.20 mm	2,017	2001120
60 AGH 400Y	400	1.50 mm	3,966	2001121
60 AGH 500Y	500	1.50 mm	5,824	2001122
60 AGH 600Y	600	1.50 mm	7,325	2001123

H100

Sipariş Kodu Order Code	W (mm)	T (mm)	Ağırlık (kg/ad) Weight (kg/pcs)	Barkod Kodu Barcode Code
100 AGH 100Y	100	1.20 mm	0,875	2001124
100 AGH 160Y	160	1.20 mm	1,174	2001125
100 AGH 200Y	200	1.20 mm	1,575	2001126
100 AGH 300Y	300	1.20 mm	2,411	2001127
100 AGH 400Y	400	1.50 mm	4,600	2001128
100 AGH 500Y	500	1.50 mm	6,252	2001129
100 AGH 600Y	600	1.50 mm	8,177	2001130

H = YÜKSEKLİK = HEIGHT / W = GENİŞLİK = WIDTH / T = KALINLIK = THICKNESS

H AGH 100 Y

Yükseklik Kanal Tipi Genişlik Modül
Height Type Width Module

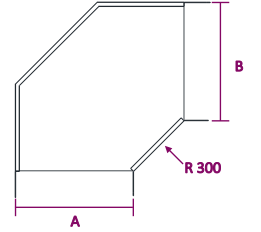
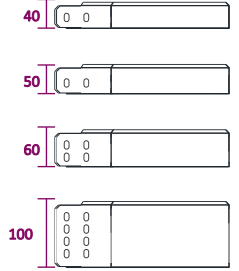

Dönüşlerde "A-B" ölçüleri esit olarak üretilmektedir. İsteğe bağlı olarak farklı ölçülerde üretim yapılır. Bends are produced same dimension for "A-B" as well as we can produce special dimensions regarding your inquiry.

ARTIM METAL ELEKTRİK A.Ş.

* Farklı kalınlık ve ölçülerde üretim yapılabılır.
* Malzeme ağırlıkları yaklaşık değerlerdir, ± %10 değişiklik gösterebilir.
* Malzeme kalınlık toleransı ± %10 dur.
* Lütfen siparişlerinizde sipariş kodu veya ürün kodu ve Kaplama şeklini belirtiniz.

* We can produce cable trays different thickness and dimensions
* Cable trays are shown approximately weight, they could change ± %10 difference.
* Cable trays thickness tolerances are shown ± %10 .
* Please indicate order code and coating type in your orders.

AGH SERIES

90° YATAY DÖNÜS R300 (MODEL1)

90° BEND R300 (MODEL1)

SICAK DALDIRMA (SD)

HOT DIP GALVANIZED (SD)

TS EN ISO 1461



H40 = H50 Tek delikli

H40 = H50 One hole



H40

Sipariş Kodu Order Code	W (mm)	T (mm)	Ağırlık (kg/ad) Weight (kg/pcs)	Barkod Kodu Barcode Code
40 AGH 050Y	50	1.50 mm	0,292	2001100
40 AGH 100Y	100	1.50 mm	0,794	2001101
40 AGH 120Y	120	1.50 mm	0,926	2001102
40 AGH 160Y	160	1.50 mm	1,058	2001103
40 AGH 200Y	200	1.50 mm	1,482	2001104
40 AGH 300Y	300	1.50 mm	2,461	2001105
40 AGH 400Y	400	2.00 mm	4,943	2001106
40 AGH 500Y	500	2.00 mm	6,975	2001107
40 AGH 600Y	600	2.00 mm	9,372	2001108

H50

Sipariş Kodu Order Code	W (mm)	T (mm)	Ağırlık (kg/ad) Weight (kg/pcs)	Barkod Kodu Barcode Code
50 AGH 050Y	50	1.50 mm	0,339	2001109
50 AGH 100Y	100	1.50 mm	0,874	2001110
50 AGH 160Y	160	1.50 mm	1,153	2001111
50 AGH 200Y	200	1.50 mm	1,604	2001112
50 AGH 300Y	300	1.50 mm	2,593	2001113
50 AGH 400Y	400	2.00 mm	5,165	2001114
50 AGH 500Y	500	2.00 mm	7,234	2001115
50 AGH 600Y	600	2.00 mm	9,668	2001116

H60

Sipariş Kodu Order Code	W (mm)	T (mm)	Ağırlık (kg/ad) Weight (kg/pcs)	Barkod Kodu Barcode Code
60 AGH 100Y	100	1.50 mm	0,963	2001117
60 AGH 160Y	160	1.50 mm	1,248	2001118
60 AGH 200Y	200	1.50 mm	1,715	2001119
60 AGH 300Y	300	1.50 mm	2,746	2001120
60 AGH 400Y	400	2.00 mm	5,398	2001121
60 AGH 500Y	500	2.00 mm	7,927	2001122
60 AGH 600Y	600	2.00 mm	9,971	2001123

H100

Sipariş Kodu Order Code	W (mm)	T (mm)	Ağırlık (kg/ad) Weight (kg/pcs)	Barkod Kodu Barcode Code
100 AGH 100Y	100	1.50 mm	1,191	2001124
100 AGH 160Y	160	1.50 mm	1,598	2001125
100 AGH 200Y	200	1.50 mm	2,144	2001126
100 AGH 300Y	300	1.50 mm	3,281	2001127
100 AGH 400Y	400	2.00 mm	6,261	2001128
100 AGH 500Y	500	2.00 mm	8,509	2001129
100 AGH 600Y	600	2.00 mm	11,129	2001130

H = YÜKSEKLİK = HEIGHT / W = GENİŞLİK = WIDTH / T = KALINLIK = THICKNESS

H AGH 100 Y

Yükseklik Kanal Tipi Genişlik Modül
Height Type Width Module

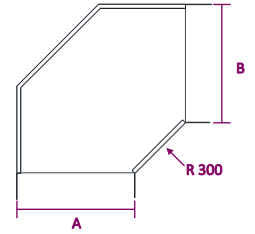

Dönüşlerde "A-B" ölçüleri eşit olarak üretilmektedir. İsteğe bağlı olarak farklı ölçülerde üretim yapılır.

Bends are produced same dimension for "A-B" as well as we can produce special dimensions regarding your inquiry.

* Farklı kalınlık ve ölçülerde üretim yapılabilmektedir.
* Malzeme ağırlıkları yaklaşık değerlerdir, \pm %10 değişiklik gösterebilir.
* Malzeme kalınlık toleransı \pm %10 dur.
* Lütfen siparişlerinizde sipariş kodu veya ürün kodu ve kaplama şeklini belirtiniz.

* We can produce cable trays different thickness and dimensions
* Cable trays are shown approximately weight, they could change \pm %10 difference.
* Cable trays thickness tolerances are shown \pm %10 .
* Please indicate order code and coating type in your orders.

AGH SERIES

90° YATAY DÖNÜŞ R450 (MODEL1)

90° BEND R450 (MODEL1)

PREGALVANIZ (PG)
PREGALVANIZED (PG)
TS EN 10346



H40 = H50 Tek delikli
H40 = H50 One hole



H40

Sipariş Kodu Order Code	W (mm)	T (mm)	Ağırlık (kg/ad) Weight (kg/pcs)	Barkod Kodu Barcode Code
40 AGH 050Y	50	1.20 mm	0,257	2001100
40 AGH 100Y	100	1.20 mm	0,700	2001101
40 AGH 120Y	120	1.20 mm	0,886	2001102
40 AGH 160Y	160	1.20 mm	0,933	2001103
40 AGH 200Y	200	1.20 mm	1,400	2001104
40 AGH 300Y	300	1.20 mm	2,170	2001105
40 AGH 400Y	400	1.50 mm	4,357	2001106
40 AGH 500Y	500	1.50 mm	6,150	2001107
40 AGH 600Y	600	1.50 mm	8,263	2001108

H50

Sipariş Kodu Order Code	W (mm)	T (mm)	Ağırlık (kg/ad) Weight (kg/pcs)	Barkod Kodu Barcode Code
50 AGH 050Y	50	1.20 mm	0,298	2001109
50 AGH 100Y	100	1.20 mm	0,770	2001110
50 AGH 160Y	160	1.20 mm	1,017	2001111
50 AGH 200Y	200	1.20 mm	1,414	2001112
50 AGH 300Y	300	1.20 mm	2,286	2001113
50 AGH 400Y	400	1.50 mm	4,554	2001114
50 AGH 500Y	500	1.50 mm	6,378	2001115
50 AGH 600Y	600	1.50 mm	8,524	2001116

H60

Sipariş Kodu Order Code	W (mm)	T (mm)	Ağırlık (kg/ad) Weight (kg/pcs)	Barkod Kodu Barcode Code
60 AGH 100Y	100	1.20 mm	0,849	2001117
60 AGH 160Y	160	1.20 mm	1,102	2001118
60 AGH 200Y	200	1.20 mm	1,511	2001119
60 AGH 300Y	300	1.20 mm	2,421	2001120
60 AGH 400Y	400	1.50 mm	4,759	2001121
60 AGH 500Y	500	1.50 mm	6,989	2001122
60 AGH 600Y	600	1.50 mm	8,789	2001123

H100

Sipariş Kodu Order Code	W (mm)	T (mm)	Ağırlık (kg/ad) Weight (kg/pcs)	Barkod Kodu Barcode Code
100 AGH 100Y	100	1.20 mm	1,050	2001124
100 AGH 160Y	160	1.20 mm	1,409	2001125
100 AGH 200Y	200	1.20 mm	1,890	2001126
100 AGH 300Y	300	1.20 mm	2,893	2001127
100 AGH 400Y	400	1.50 mm	5,520	2001128
100 AGH 500Y	500	1.50 mm	7,503	2001129
100 AGH 600Y	600	1.50 mm	9,812	2001130

H = YÜKSEKLİK = HEIGHT / W = GENİŞLİK = WIDTH / T = KALINLIK = THICKNESS

H AGH 100 Y

Yükseklik Kanal Tipi Genişlik Modül
Height Type Width Module

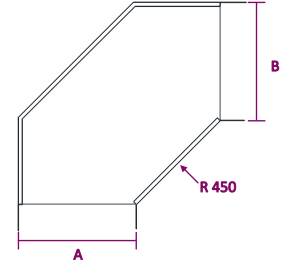
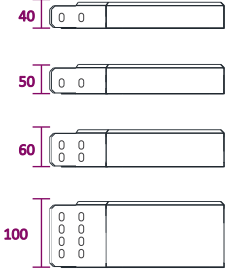

Dönüşlerde "A-B" ölçüleri eşit olarak üretilmektedir. İsteğe bağlı olarak farklı ölçülerde üretim yapılır. Bends are produced same dimension for "A-B" as well as we can produce special dimensions regarding your inquiry.

ARTIM METAL ELEKTRİK A.Ş.

* Farklı kalınlık ve ölçülerde üretim yapılabılır.
* Malzeme ağırlıkları yaklaşık değerlerdir, ± %10 değişiklik gösterebilir.
* Malzeme kalınlık toleransı ± %10 dur.
* Lütfen siparişlerinizde sipariş kodu veya ürün kodu ve Kaplama şeklini belirtiniz.

* We can produce cable trays different thickness and dimensions
* Cable trays are shown approximately weight, they could change ± %10 difference.
* Cable trays thickness tolerances are shown ± %10 .
* Please indicate order code and coating type in your orders.

AGH SERIES

90° YATAY DÖNÜŞ R450 (MODEL1)

90° BEND R450 (MODEL1)

SICAK DALDIRMA (SD)

HOT DIP GALVANIZED (SD)

TS EN ISO 1461



H40 = H50 Tek delikli
H40 = H50 One hole



H40

Sipariş Kodu Order Code	W (mm)	T (mm)	Ağırlık (kg/ad) Weight (kg/pcs)	Barkod Kodu Barcode Code
40 AGH 050Y	50	1.50 mm	0,350	2001100
40 AGH 100Y	100	1.50 mm	0,953	2001101
40 AGH 120Y	120	1.50 mm	1,111	2001102
40 AGH 160Y	160	1.50 mm	1,270	2001103
40 AGH 200Y	200	1.50 mm	1,778	2001104
40 AGH 300Y	300	1.50 mm	2,954	2001105
40 AGH 400Y	400	2.00 mm	5,932	2001106
40 AGH 500Y	500	2.00 mm	8,370	2001107
40 AGH 600Y	600	2.00 mm	11,247	2001108

H50

Sipariş Kodu Order Code	W (mm)	T (mm)	Ağırlık (kg/ad) Weight (kg/pcs)	Barkod Kodu Barcode Code
50 AGH 050Y	50	1.50 mm	0,407	2001109
50 AGH 100Y	100	1.50 mm	1,048	2001110
50 AGH 160Y	160	1.50 mm	1,384	2001111
50 AGH 200Y	200	1.50 mm	1,925	2001112
50 AGH 300Y	300	1.50 mm	3,112	2001113
50 AGH 400Y	400	2.00 mm	6,197	2001114
50 AGH 500Y	500	2.00 mm	8,681	2001115
50 AGH 600Y	600	2.00 mm	11,602	2001116

H60

Sipariş Kodu Order Code	W (mm)	T (mm)	Ağırlık (kg/ad) Weight (kg/pcs)	Barkod Kodu Barcode Code
60 AGH 100Y	100	1.50 mm	1,156	2001117
60 AGH 160Y	160	1.50 mm	1,498	2001118
60 AGH 200Y	200	1.50 mm	2,058	2001119
60 AGH 300Y	300	1.50 mm	3,296	2001120
60 AGH 400Y	400	2.00 mm	6,477	2001121
60 AGH 500Y	500	2.00 mm	9,513	2001122
60 AGH 600Y	600	2.00 mm	11,965	2001123

H100

Sipariş Kodu Order Code	W (mm)	T (mm)	Ağırlık (kg/ad) Weight (kg/pcs)	Barkod Kodu Barcode Code
100 AGH 100Y	100	1.50 mm	1,429	2001124
100 AGH 160Y	160	1.50 mm	1,918	2001125
100 AGH 200Y	200	1.50 mm	2,573	2001126
100 AGH 300Y	300	1.50 mm	3,937	2001127
100 AGH 400Y	400	2.00 mm	7,513	2001128
100 AGH 500Y	500	2.00 mm	10,211	2001129
100 AGH 600Y	600	2.00 mm	13,355	2001130

H = YÜKSEKLİK = HEIGHT / W = GENİŞLİK = WIDTH / T = KALINLIK = THICKNESS

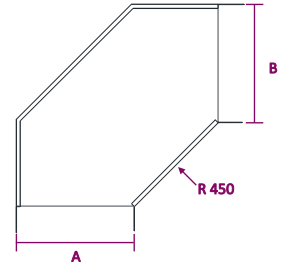
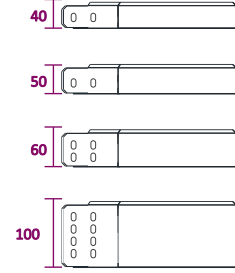
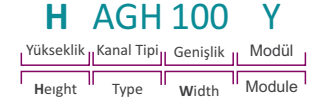

Dönüşlerde "A-B" ölçüleri esit olarak üretilmektedir. İsteğe bağlı olarak farklı ölçülerde üretim yapılır. Bends are produced same dimension for "A-B" as well as we can produce special dimensions regarding your inquiry.

* Farklı kalınlık ve ölçülerde üretim yapılabılır.
* Malzeme ağırlıkları yaklaşık değerlerdir, ± %10 değişiklik gösterebilir.
* Malzeme kalınlık toleransı ± %10 dur.
* Lütfen siparişlerinizde sipariş kodu veya ürün kodu ve Kaplama şeklini belirtiniz.

* We can produce cable trays different thickness and dimensions
* Cable trays are shown approximately weight, they could change ± %10 difference.
* Cable trays thickness tolerances are shown ± %10 .
* Please indicate order code and coating type in your orders.

AGH SERIES

90° YATAY DÖNÜŞ R600 (MODEL1)

90° BEND R600 (MODEL1)

PREGALVANIZ (PG)
PREGALVANIZED (PG)
TS EN 10346



H40 = H50 Tek delikli
H40 = H50 One hole



H40

Sipariş Kodu Order Code	W (mm)	T (mm)	Ağırlık (kg/ad) Weight (kg/pcs)	Barkod Kodu Barcode Code
40 AGH 050Y	50	1.20 mm	0,298	2001100
40 AGH 100Y	100	1.20 mm	0,812	2001101
40 AGH 120Y	120	1.20 mm	1,028	2001102
40 AGH 160Y	160	1.20 mm	1,082	2001103
40 AGH 200Y	200	1.20 mm	1,624	2001104
40 AGH 300Y	300	1.20 mm	2,517	2001105
40 AGH 400Y	400	1.50 mm	5,054	2001106
40 AGH 500Y	500	1.50 mm	7,133	2001107
40 AGH 600Y	600	1.50 mm	9,585	2001108

H50

Sipariş Kodu Order Code	W (mm)	T (mm)	Ağırlık (kg/ad) Weight (kg/pcs)	Barkod Kodu Barcode Code
50 AGH 050Y	50	1.20 mm	0,346	2001109
50 AGH 100Y	100	1.20 mm	0,893	2001110
50 AGH 160Y	160	1.20 mm	1,180	2001111
50 AGH 200Y	200	1.20 mm	1,640	2001112
50 AGH 300Y	300	1.20 mm	2,652	2001113
50 AGH 400Y	400	1.50 mm	5,283	2001114
50 AGH 500Y	500	1.50 mm	7,398	2001115
50 AGH 600Y	600	1.50 mm	9,888	2001116

H60

Sipariş Kodu Order Code	W (mm)	T (mm)	Ağırlık (kg/ad) Weight (kg/pcs)	Barkod Kodu Barcode Code
60 AGH 100Y	100	1.20 mm	0,985	2001117
60 AGH 160Y	160	1.20 mm	1,278	2001118
60 AGH 200Y	200	1.20 mm	1,753	2001119
60 AGH 300Y	300	1.20 mm	2,808	2001120
60 AGH 400Y	400	1.50 mm	5,520	2001121
60 AGH 500Y	500	1.50 mm	8,108	2001122
60 AGH 600Y	600	1.50 mm	10,196	2001123

H100

Sipariş Kodu Order Code	W (mm)	T (mm)	Ağırlık (kg/ad) Weight (kg/pcs)	Barkod Kodu Barcode Code
100 AGH 100Y	100	1.20 mm	1,218	2001124
100 AGH 160Y	160	1.20 mm	1,634	2001125
100 AGH 200Y	200	1.20 mm	2,192	2001126
100 AGH 300Y	300	1.20 mm	3,355	2001127
100 AGH 400Y	400	1.50 mm	6,403	2001128
100 AGH 500Y	500	1.50 mm	8,703	2001129
100 AGH 600Y	600	1.50 mm	11,382	2001130

H = YÜKSEKLİK = HEIGHT / W = GENİŞLİK = WIDTH / T = KALINLIK = THICKNESS

H AGH 100 Y

Yükseklik Kanal Tipi Genişlik Modül
Height Type Width Module

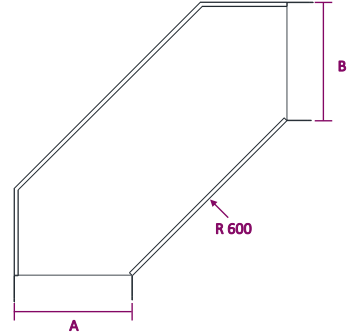
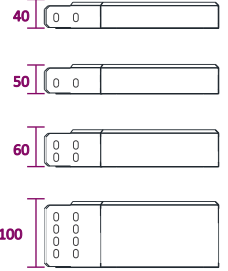

Dönüşlerde "A-B" ölçüleri esit olarak üretilmektedir. İsteğe bağlı olarak farklı ölçülerde üretim yapılır. Bends are produced same dimension for "A-B" as well as we can produce special dimensions regarding your inquiry.

ARTIM METAL ELEKTRİK A.Ş.

* Farklı kalınlık ve ölçülerde üretim yapılabılır.
* Malzeme ağırlıkları yaklaşık değerlerdir, ± %10 değişiklik gösterebilir.
* Malzeme kalınlık toleransı ± %10 dur.
* Lütfen siparişlerinizde sipariş kodu veya ürün kodu ve Kaplama şeklini belirtiniz.

* We can produce cable trays different thickness and dimensions
* Cable trays are shown approximately weight, they could change ± %10 difference.
* Cable trays thickness tolerances are shown ± %10 .
* Please indicate order code and coating type in your orders.

AGH SERIES

90° YATAY DÖNÜS R600 (MODEL1)

90° BEND R600 (MODEL1)

SICAK DALDIRMA (SD)

HOT DIP GALVANIZED (SD)

TS EN ISO 1461



H40 = H50 Tek delikli

H40 = H50 One hole



H40

Sipariş Kodu Order Code	W (mm)	T (mm)	Ağırlık (kg/ad) Weight (kg/pcs)	Barkod Kodu Barcode Code
40 AGH 050Y	50	1.50 mm	0,406	2001100
40 AGH 100Y	100	1.50 mm	1,105	2001101
40 AGH 120Y	120	1.50 mm	1,288	2001102
40 AGH 160Y	160	1.50 mm	1,473	2001103
40 AGH 200Y	200	1.50 mm	2,063	2001104
40 AGH 300Y	300	1.50 mm	3,426	2001105
40 AGH 400Y	400	2.00 mm	6,881	2001106
40 AGH 500Y	500	2.00 mm	9,709	2001107
40 AGH 600Y	600	2.00 mm	13,046	2001108

H50

Sipariş Kodu Order Code	W (mm)	T (mm)	Ağırlık (kg/ad) Weight (kg/pcs)	Barkod Kodu Barcode Code
50 AGH 050Y	50	1.50 mm	0,472	2001109
50 AGH 100Y	100	1.50 mm	1,216	2001110
50 AGH 160Y	160	1.50 mm	1,606	2001111
50 AGH 200Y	200	1.50 mm	2,232	2001112
50 AGH 300Y	300	1.50 mm	3,610	2001113
50 AGH 400Y	400	2.00 mm	7,189	2001114
50 AGH 500Y	500	2.00 mm	10,070	2001115
50 AGH 600Y	600	2.00 mm	13,458	2001116

H60

Sipariş Kodu Order Code	W (mm)	T (mm)	Ağırlık (kg/ad) Weight (kg/pcs)	Barkod Kodu Barcode Code
60 AGH 100Y	100	1.50 mm	1,341	2001117
60 AGH 160Y	160	1.50 mm	1,738	2001118
60 AGH 200Y	200	1.50 mm	2,387	2001119
60 AGH 300Y	300	1.50 mm	3,823	2001120
60 AGH 400Y	400	2.00 mm	7,514	2001121
60 AGH 500Y	500	2.00 mm	11,035	2001122
60 AGH 600Y	600	2.00 mm	13,879	2001123

H100

Sipariş Kodu Order Code	W (mm)	T (mm)	Ağırlık (kg/ad) Weight (kg/pcs)	Barkod Kodu Barcode Code
100 AGH 100Y	100	1.50 mm	1,658	2001124
100 AGH 160Y	160	1.50 mm	2,225	2001125
100 AGH 200Y	200	1.50 mm	2,984	2001126
100 AGH 300Y	300	1.50 mm	4,567	2001127
100 AGH 400Y	400	2.00 mm	8,715	2001128
100 AGH 500Y	500	2.00 mm	11,845	2001129
100 AGH 600Y	600	2.00 mm	15,492	2001130

H = YÜKSEKLİK = HEIGHT / W = GENİŞLİK = WIDTH / T = KALINLIK = THICKNESS

H AGH 100 Y

Yükseklik | Kanal Tipi | Genişlik | Modül
Height | Type | Width | Module

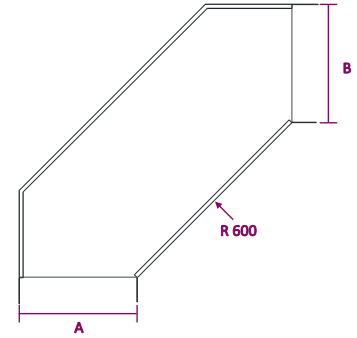
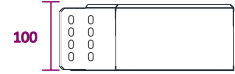

Dönüşlerde "A-B" ölçüleri esit olarak üretilmektedir. İsteğe bağlı olarak farklı ölçülerde üretim yapılır.

Bends are produced same dimension for "A-B" as well as we can produce special dimensions regarding your inquiry.

* Farklı kalınlık ve ölçülerde üretim yapılabılır.
* Malzeme ağırlıkları yaklaşık değerlerdir, ± %10 değişiklik gösterebilir.
* Malzeme kalınlık toleransı ± %10 dur.
* Lütfen siparişinizde sipariş kodu veya ürün kodu ve Kaplama şeklini belirtiniz.

* We can produce cable trays different thickness and dimensions
* Cable trays are shown approximately weight, they could change ± %10 difference.
* Cable trays thickness tolerances are shown ± %10 .
* Please indicate order code and coating type in your orders.

AGH SERIES

T BAGLANTI R300 (MODEL1)

T BEND R300 (MODEL1)

PREGALVANIZ (PG)
PREGALVANIZED (PG)
TS EN 10346



H40 = H50 Tek delikli
H40 = H50 One hole



H40

Sipariş Kodu Order Code	W (mm)	T (mm)	Ağırlık (kg/ad) Weight (kg/pcs)	Barkod Kodu Barcode Code
40 AGH 050T	50	1.20 mm	0,284	2001200
40 AGH 100T	100	1.20 mm	0,696	2001201
40 AGH 120T	120	1.20 mm	0,853	2001202
40 AGH 160T	160	1.20 mm	1,212	2001203
40 AGH 200T	200	1.20 mm	1,205	2001204
40 AGH 300T	300	1.20 mm	1,925	2001205
40 AGH 400T	400	1.50 mm	5,039	2001206
40 AGH 500T	500	1.50 mm	5,273	2001207
40 AGH 600T	600	1.50 mm	7,030	2001208

H50

Sipariş Kodu Order Code	W (mm)	T (mm)	Ağırlık (kg/ad) Weight (kg/pcs)	Barkod Kodu Barcode Code
50 AGH 050T	50	1.20 mm	0,326	2001209
50 AGH 100T	100	1.20 mm	0,773	2001210
50 AGH 160T	160	1.20 mm	0,964	2001211
50 AGH 200T	200	1.20 mm	1,298	2001212
50 AGH 300T	300	1.20 mm	2,022	2001213
50 AGH 400T	400	1.50 mm	3,919	2001214
50 AGH 500T	500	1.50 mm	5,424	2001215
50 AGH 600T	600	1.50 mm	7,197	2001216

H60

Sipariş Kodu Order Code	W (mm)	T (mm)	Ağırlık (kg/ad) Weight (kg/pcs)	Barkod Kodu Barcode Code
60 AGH 100T	100	1.20 mm	0,848	2001217
60 AGH 160T	160	1.20 mm	1,038	2001218
60 AGH 200T	200	1.20 mm	1,380	2001219
60 AGH 300T	300	1.20 mm	2,115	2001220
60 AGH 400T	400	1.50 mm	4,067	2001221
60 AGH 500T	500	1.50 mm	5,579	2001222
60 AGH 600T	600	1.50 mm	7,363	2001223

H100

Sipariş Kodu Order Code	W (mm)	T (mm)	Ağırlık (kg/ad) Weight (kg/pcs)	Barkod Kodu Barcode Code
100 AGH 100T	100	1.20 mm	1,108	2001224
100 AGH 160T	160	1.20 mm	1,298	2001225
100 AGH 200T	200	1.20 mm	1,684	2001226
100 AGH 300T	300	1.20 mm	2,457	2001227
100 AGH 400T	400	1.50 mm	4,573	2001228
100 AGH 500T	500	1.50 mm	6,143	2001229
100 AGH 600T	600	1.50 mm	7,986	2001230

H = YÜKSEKLİK = HEIGHT / W = GENİŞLİK = WIDTH / T = KALINLIK = THICKNESS

H AGH 100 T
Yükseklik Kanal Tipi Genişlik Modül
Height Type Width Module

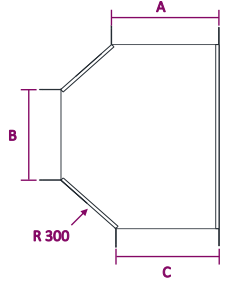
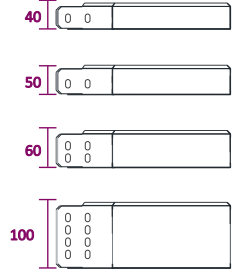

Dönüşlerde "A-B-C" ölçüleri esit olarak üretilmektedir. İsteğe bağlı olarak farklı ölçülerde üretim yapılır. Bends are produced same dimension for "A-B-C" as well as we can produce special dimensions regarding your inquiry.

ARTIM METAL ELEKTRİK A.Ş.

* Farklı kalınlık ve ölçülerde üretim yapılabılır.
* Malzeme ağırlıkları yaklaşık değerlerdir, ± %10 değişiklik gösterebilir.
* Malzeme kalınlık toleransı ± %10 dur.
* Lütfen siparişlerinizde sipariş kodu veya ürün kodu ve Kaplama şeklini belirtiniz.

* We can produce cable trays different thickness and dimensions
* Cable trays are shown approximately weight, they could change ± %10 difference.
* Cable trays thickness tolerances are shown ± %10 .
* Please indicate order code and coating type in your orders.

AGH SERIES

T BAGLANTI R300 (MODEL1)

T BEND R300 (MODEL1)

SICAK DALDIRMA (SD)

HOT DIP GALVANIZED (HDG)

TS EN ISO 1461



H40 = H50 Tek delikli
H40 = H50 One hole



H40

Sipariş Kodu Order Code	W (mm)	T (mm)	Ağırlık (kg/ad) Weight (kg/pcs)	Barkod Kodu Barcode Code
40 AGH 050T	50	1.50 mm	0,387	2001200
40 AGH 100T	100	1.50 mm	0,947	2001201
40 AGH 120T	120	1.50 mm	1,080	2001202
40 AGH 160T	160	1.50 mm	1,212	2001203
40 AGH 200T	200	1.50 mm	1,641	2001204
40 AGH 300T	300	1.50 mm	2,620	2001205
40 AGH 400T	400	2.00 mm	6,858	2001206
40 AGH 500T	500	2.00 mm	7,176	2001207
40 AGH 600T	600	2.00 mm	9,568	2001208

H50

Sipariş Kodu Order Code	W (mm)	T (mm)	Ağırlık (kg/ad) Weight (kg/pcs)	Barkod Kodu Barcode Code
50 AGH 050T	50	1.50 mm	0,445	2001209
50 AGH 100T	100	1.50 mm	1,053	2001210
50 AGH 160T	160	1.50 mm	1,312	2001211
50 AGH 200T	200	1.50 mm	1,768	2001212
50 AGH 300T	300	1.50 mm	2,752	2001213
50 AGH 400T	400	2.00 mm	5,334	2001214
50 AGH 500T	500	2.00 mm	7,383	2001215
50 AGH 600T	600	2.00 mm	9,796	2001216

H60

Sipariş Kodu Order Code	W (mm)	T (mm)	Ağırlık (kg/ad) Weight (kg/pcs)	Barkod Kodu Barcode Code
60 AGH 100T	100	1.50 mm	1,153	2001217
60 AGH 160T	160	1.50 mm	1,413	2001218
60 AGH 200T	200	1.50 mm	1,879	2001219
60 AGH 300T	300	1.50 mm	2,879	2001220
60 AGH 400T	400	2.00 mm	5,535	2001221
60 AGH 500T	500	2.00 mm	7,595	2001222
60 AGH 600T	600	2.00 mm	10,023	2001223

H100

Sipariş Kodu Order Code	W (mm)	T (mm)	Ağırlık (kg/ad) Weight (kg/pcs)	Barkod Kodu Barcode Code
100 AGH 100T	100	1.50 mm	1,509	2001224
100 AGH 160T	160	1.50 mm	1,768	2001225
100 AGH 200T	200	1.50 mm	2,292	2001226
100 AGH 300T	300	1.50 mm	3,345	2001227
100 AGH 400T	400	2.00 mm	6,223	2001228
100 AGH 500T	500	2.00 mm	8,361	2001229
100 AGH 600T	600	2.00 mm	10,870	2001230

H = YÜKSEKLİK = HEIGHT / W = GENİŞLİK = WIDTH / T = KALINLIK = THICKNESS

H AGH 100 T

Yükseklik Kanal Tipi Genişlik Modül
Height Type Width Module

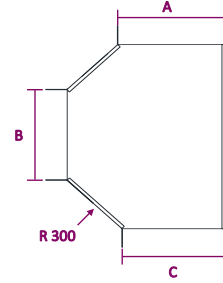

Dönüşlerde "A-B-C" ölçüleri esit olarak üretilmektedir. İsteğe bağlı olarak farklı ölçülerde üretim yapılır. Bends are produced same dimension for "A-B-C" as well as we can produce special dimensions regarding your inquiry.

* Farklı kalınlık ve ölçülerde üretim yapılabılır.
* Malzeme ağırlıkları yaklaşık değerlerdir, ± %10 değişiklik gösterebilir.
* Malzeme kalınlık toleransı ± %10 dur.
* Lütfen siparişlerinizde sipariş kodu veya ürün kodu ve Kaplama şeklini belirtiniz.

* We can produce cable trays different thickness and dimensions
* Cable trays are shown approximately weight, they could change ± %10 difference.
* Cable trays thickness tolerances are shown ± %10 .
* Please indicate order code and coating type in your orders.

AGH SERIES

T BAGLANTI R450 (MODEL1)

T BEND R450 (MODEL1)

PREGALVANIZ (PG)
PREGALVANIZED (PG)
TS EN 10346



H40 = H50 Tek delikli
H40 = H50 One hole



H40

Sipariş Kodu Order Code	W (mm)	T (mm)	Ağırlık (kg/ad) Weight (kg/pcs)	Barkod Kodu Barcode Code
40 AGH 050T	50	1.20 mm	0,341	2001200
40 AGH 100T	100	1.20 mm	0,835	2001201
40 AGH 120T	120	1.20 mm	1,024	2001202
40 AGH 160T	160	1.20 mm	1,454	2001203
40 AGH 200T	200	1.20 mm	1,446	2001204
40 AGH 300T	300	1.20 mm	2,309	2001205
40 AGH 400T	400	1.50 mm	6,047	2001206
40 AGH 500T	500	1.50 mm	6,327	2001207
40 AGH 600T	600	1.50 mm	8,436	2001208

H50

Sipariş Kodu Order Code	W (mm)	T (mm)	Ağırlık (kg/ad) Weight (kg/pcs)	Barkod Kodu Barcode Code
50 AGH 050T	50	1.20 mm	0,391	2001209
50 AGH 100T	100	1.20 mm	0,928	2001210
50 AGH 160T	160	1.20 mm	1,157	2001211
50 AGH 200T	200	1.20 mm	1,558	2001212
50 AGH 300T	300	1.20 mm	2,426	2001213
50 AGH 400T	400	1.50 mm	4,703	2001214
50 AGH 500T	500	1.50 mm	6,509	2001215
50 AGH 600T	600	1.50 mm	8,637	2001216

H60

Sipariş Kodu Order Code	W (mm)	T (mm)	Ağırlık (kg/ad) Weight (kg/pcs)	Barkod Kodu Barcode Code
60 AGH 100T	100	1.20 mm	1,017	2001217
60 AGH 160T	160	1.20 mm	1,245	2001218
60 AGH 200T	200	1.20 mm	1,656	2001219
60 AGH 300T	300	1.20 mm	2,538	2001220
60 AGH 400T	400	1.50 mm	4,881	2001221
60 AGH 500T	500	1.50 mm	6,695	2001222
60 AGH 600T	600	1.50 mm	8,836	2001223

H100

Sipariş Kodu Order Code	W (mm)	T (mm)	Ağırlık (kg/ad) Weight (kg/pcs)	Barkod Kodu Barcode Code
100 AGH 100T	100	1.20 mm	1,330	2001224
100 AGH 160T	160	1.20 mm	1,558	2001225
100 AGH 200T	200	1.20 mm	2,020	2001226
100 AGH 300T	300	1.20 mm	2,948	2001227
100 AGH 400T	400	1.50 mm	5,487	2001228
100 AGH 500T	500	1.50 mm	7,372	2001229
100 AGH 600T	600	1.50 mm	9,583	2001230

H = YÜKSEKLİK = HEIGHT / W = GENİŞLİK = WIDTH / T = KALINLIK = THICKNESS

H AGH 100 T

Yükseklik Kanal Tipi Genişlik Modül
Height Type Width Module

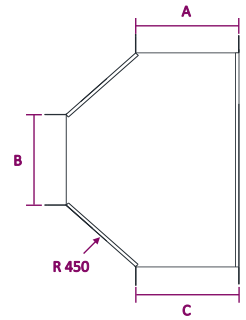
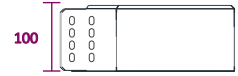
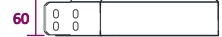

Dönüşlerde "A-B-C" ölçüleri eşit olarak üretilmektedir. İsteğe bağlı olarak farklı ölçülerde üretim yapılır. Bends are produced same dimension for "A-B-C" as well as we can produce special dimensions regarding your inquiry.

ARTIM METAL ELEKTRİK A.Ş.

* Farklı kalınlık ve ölçülerde üretim yapılabılır.
* Malzeme ağırlıkları yaklaşık değerlerdir, ± %10 değişiklik gösterebilir.
* Malzeme kalınlık toleransı ± %10 dur.
* Lütfen siparişlerinizde sipariş kodu veya ürün kodu ve Kaplama şeklini belirtiniz.

* We can produce cable trays different thickness and dimensions
* Cable trays are shown approximately weight, they could change ± %10 difference.
* Cable trays thickness tolerances are shown ± %10 .
* Please indicate order code and coating type in your orders.

AGH SERIES

T BAĞLANTI R450 (MODEL1)

T BEND R450 (MODEL1)

SICAK DALDIRMA (SD)

HOT DIP GALVANIZED (HDG)

TS EN ISO 1461



H40 = H50 Tek delikli

H40 = H50 One hole

H40

Sipariş Kodu Order Code	W (mm)	T (mm)	Ağırlık (kg/ad) Weight (kg/pcs)	Barkod Kodu Barcode Code
40 AGH 050T	50	1.50 mm	0,464	2001200
40 AGH 100T	100	1.50 mm	1,137	2001201
40 AGH 120T	120	1.50 mm	1,296	2001202
40 AGH 160T	160	1.50 mm	1,454	2001203
40 AGH 200T	200	1.50 mm	1,969	2001204
40 AGH 300T	300	1.50 mm	3,144	2001205
40 AGH 400T	400	2.00 mm	8,230	2001206
40 AGH 500T	500	2.00 mm	8,611	2001207
40 AGH 600T	600	2.00 mm	11,481	2001208

H50

Sipariş Kodu Order Code	W (mm)	T (mm)	Ağırlık (kg/ad) Weight (kg/pcs)	Barkod Kodu Barcode Code
50 AGH 050T	50	1.50 mm	0,534	2001209
50 AGH 100T	100	1.50 mm	1,264	2001210
50 AGH 160T	160	1.50 mm	1,575	2001211
50 AGH 200T	200	1.50 mm	2,122	2001212
50 AGH 300T	300	1.50 mm	3,302	2001213
50 AGH 400T	400	2.00 mm	6,401	2001214
50 AGH 500T	500	2.00 mm	8,859	2001215
50 AGH 600T	600	2.00 mm	11,755	2001216

H60

Sipariş Kodu Order Code	W (mm)	T (mm)	Ağırlık (kg/ad) Weight (kg/pcs)	Barkod Kodu Barcode Code
60 AGH 100T	100	1.50 mm	1,384	2001217
60 AGH 160T	160	1.50 mm	1,695	2001218
60 AGH 200T	200	1.50 mm	2,255	2001219
60 AGH 300T	300	1.50 mm	3,455	2001220
60 AGH 400T	400	2.00 mm	6,642	2001221
60 AGH 500T	500	2.00 mm	9,113	2001222
60 AGH 600T	600	2.00 mm	12,028	2001223

H100

Sipariş Kodu Order Code	W (mm)	T (mm)	Ağırlık (kg/ad) Weight (kg/pcs)	Barkod Kodu Barcode Code
100 AGH 100T	100	1.50 mm	1,811	2001224
100 AGH 160T	160	1.50 mm	2,122	2001225
100 AGH 200T	200	1.50 mm	2,750	2001226
100 AGH 300T	300	1.50 mm	4,014	2001227
100 AGH 400T	400	2.00 mm	7,468	2001228
100 AGH 500T	500	2.00 mm	10,034	2001229
100 AGH 600T	600	2.00 mm	13,044	2001230

H = YÜKSEKLİK = HEIGHT / W = GENİŞLİK = WIDTH / T = KALINLIK = THICKNESS

H AGH 100 T

Yükseklik Kanal Tipi Genişlik Modül
Height Type Width Module

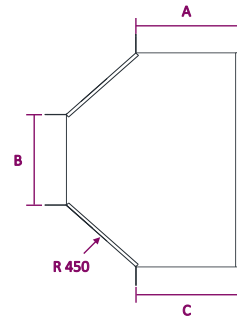
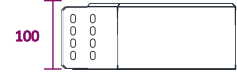

Dönüşlerde "A-B-C" ölçüleri esit olarak üretilmektedir. İsteğe bağlı olarak farklı ölçülerde üretim yapılır.

Bends are produced same dimension for "A-B-C" as well as we can produce special dimensions regarding your inquiry.

* Farklı kalınlık ve ölçülerde üretim yapılabılır.
* Malzeme ağırlıkları yaklaşık değerlerdir, ± %10 değişiklik gösterebilir.
* Malzeme kalınlık toleransı ± %10 dur.
* Lütfen siparişlerinizde sipariş kodu veya ürün kodu ve Kaplama şeklini belirtiniz.

* We can produce cable trays different thickness and dimensions
* Cable trays are shown approximately weight, they could change ± %10 difference.
* Cable trays thickness tolerances are shown ± %10 .
* Please indicate order code and coating type in your orders.

AGH SERIES

T BAGLANTI R600 (MODEL1)

T BEND R600 (MODEL1)

PREGALVANİZ (PG)
PREGALVANİZED (PG)
TS EN 10346



H40 = H50 Tek delikli
H40 = H50 One hole



H40

Sipariş Kodu Order Code	W (mm)	T (mm)	Ağırlık (kg/ad) Weight (kg/pcs)	Barkod Kodu Barcode Code
40 AGH 050T	50	1.20 mm	0,395	2001200
40 AGH 100T	100	1.20 mm	0,968	2001201
40 AGH 120T	120	1.20 mm	1,188	2001202
40 AGH 160T	160	1.20 mm	1,687	2001203
40 AGH 200T	200	1.20 mm	1,678	2001204
40 AGH 300T	300	1.20 mm	2,679	2001205
40 AGH 400T	400	1.50 mm	7,015	2001206
40 AGH 500T	500	1.50 mm	7,339	2001207
40 AGH 600T	600	1.50 mm	9,785	2001208

H50

Sipariş Kodu Order Code	W (mm)	T (mm)	Ağırlık (kg/ad) Weight (kg/pcs)	Barkod Kodu Barcode Code
50 AGH 050T	50	1.20 mm	0,454	2001209
50 AGH 100T	100	1.20 mm	1,076	2001210
50 AGH 160T	160	1.20 mm	1,343	2001211
50 AGH 200T	200	1.20 mm	1,807	2001212
50 AGH 300T	300	1.20 mm	2,814	2001213
50 AGH 400T	400	1.50 mm	5,456	2001214
50 AGH 500T	500	1.50 mm	7,550	2001215
50 AGH 600T	600	1.50 mm	10,018	2001216

H60

Sipariş Kodu Order Code	W (mm)	T (mm)	Ağırlık (kg/ad) Weight (kg/pcs)	Barkod Kodu Barcode Code
60 AGH 100T	100	1.20 mm	1,180	2001217
60 AGH 160T	160	1.20 mm	1,445	2001218
60 AGH 200T	200	1.20 mm	1,921	2001219
60 AGH 300T	300	1.20 mm	2,944	2001220
60 AGH 400T	400	1.50 mm	5,662	2001221
60 AGH 500T	500	1.50 mm	7,766	2001222
60 AGH 600T	600	1.50 mm	10,250	2001223

H100

Sipariş Kodu Order Code	W (mm)	T (mm)	Ağırlık (kg/ad) Weight (kg/pcs)	Barkod Kodu Barcode Code
100 AGH 100T	100	1.20 mm	1,542	2001224
100 AGH 160T	160	1.20 mm	1,807	2001225
100 AGH 200T	200	1.20 mm	2,344	2001226
100 AGH 300T	300	1.20 mm	3,420	2001227
100 AGH 400T	400	1.50 mm	6,365	2001228
100 AGH 500T	500	1.50 mm	8,551	2001229
100 AGH 600T	600	1.50 mm	11,116	2001230

H = YÜKSEKLİK = HEIGHT / W = GENİŞLİK = WIDTH / T = KALINLIK = THICKNESS

H AGH 100 T

Yükseklik Kanal Tipi Genişlik Modül
Height Type Width Module

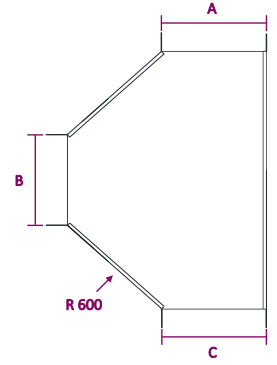
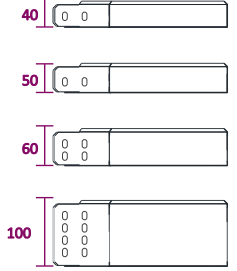

Dönüşlerde "A-B-C" ölçüleri eşit olarak üretilmektedir. İsteğe bağlı olarak farklı ölçülerde üretim yapılır. Bends are produced same dimension for "A-B-C" as well as we can produce special dimensions regarding your inquiry.

ARTIM METAL ELEKTRİK A.Ş.

* Farklı kalınlık ve ölçülerde üretim yapılabılır.
* Malzeme ağırlıkları yaklaşık değerlerdir, ± %10 değişiklik gösterebilir.
* Malzeme kalınlık toleransı ± %10 dur.
* Lütfen siparişlerinizde sipariş kodu veya ürün kodu ve Kaplama şeklini belirtiniz.

* We can produce cable trays different thickness and dimensions
* Cable trays are shown approximately weight, they could change ± %10 difference.
* Cable trays thickness tolerances are shown ± %10 .
* Please indicate order code and coating type in your orders.

AGH SERIES

T BAGLANTI R600 (MODEL1)

T BEND R600 (MODEL1)

SICAK DALDIRMA (SD)

HOT DIP GALVANIZED (HDG)

TS EN ISO 1461



H40 = H50 Tek delikli
H40 = H50 One hole



H40

Sipariş Kodu Order Code	W (mm)	T (mm)	Ağırlık (kg/ad) Weight (kg/pcs)	Barkod Kodu Barcode Code
40 AGH 050T	50	1.50 mm	0,538	2001200
40 AGH 100T	100	1.50 mm	1,318	2001201
40 AGH 120T	120	1.50 mm	1,503	2001202
40 AGH 160T	160	1.50 mm	1,687	2001203
40 AGH 200T	200	1.50 mm	2,284	2001204
40 AGH 300T	300	1.50 mm	3,647	2001205
40 AGH 400T	400	2.00 mm	9,546	2001206
40 AGH 500T	500	2.00 mm	9,988	2001207
40 AGH 600T	600	2.00 mm	13,318	2001208

H50

Sipariş Kodu Order Code	W (mm)	T (mm)	Ağırlık (kg/ad) Weight (kg/pcs)	Barkod Kodu Barcode Code
50 AGH 050T	50	1.50 mm	0,619	2001209
50 AGH 100T	100	1.50 mm	1,466	2001210
50 AGH 160T	160	1.50 mm	1,827	2001211
50 AGH 200T	200	1.50 mm	2,461	2001212
50 AGH 300T	300	1.50 mm	3,831	2001213
50 AGH 400T	400	2.00 mm	7,425	2001214
50 AGH 500T	500	2.00 mm	10,277	2001215
50 AGH 600T	600	2.00 mm	13,635	2001216

H60

Sipariş Kodu Order Code	W (mm)	T (mm)	Ağırlık (kg/ad) Weight (kg/pcs)	Barkod Kodu Barcode Code
60 AGH 100T	100	1.50 mm	1,606	2001217
60 AGH 160T	160	1.50 mm	1,966	2001218
60 AGH 200T	200	1.50 mm	2,616	2001219
60 AGH 300T	300	1.50 mm	4,008	2001220
60 AGH 400T	400	2.00 mm	7,705	2001221
60 AGH 500T	500	2.00 mm	10,572	2001222
60 AGH 600T	600	2.00 mm	13,953	2001223

H100

Sipariş Kodu Order Code	W (mm)	T (mm)	Ağırlık (kg/ad) Weight (kg/pcs)	Barkod Kodu Barcode Code
100 AGH 100T	100	1.50 mm	2,100	2001224
100 AGH 160T	160	1.50 mm	2,461	2001225
100 AGH 200T	200	1.50 mm	3,190	2001226
100 AGH 300T	300	1.50 mm	4,656	2001227
100 AGH 400T	400	2.00 mm	8,662	2001228
100 AGH 500T	500	2.00 mm	11,639	2001229
100 AGH 600T	600	2.00 mm	15,131	2001230

H = YÜKSEKLİK = HEIGHT / W = GENİŞLİK = WIDTH / T = KALINLIK = THICKNESS

H AGH 100 T

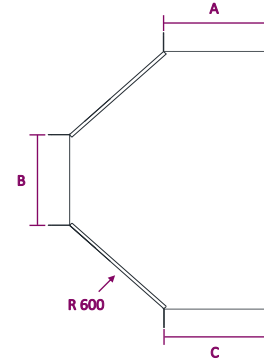
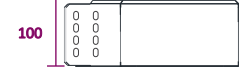

Dönüşlerde "A-B-C" ölçüleri esit olarak üretilmektedir. İsteğe bağlı olarak farklı ölçülerde üretim yapılır.
Bends are produced same dimension for "A-B-C" as well as we can produce special dimensions regarding your inquiry.

* Farklı kalınlık ve ölçülerde üretim yapılabılır.
* Malzeme ağırlıkları yaklaşık değerlerdir, ± %10 değişiklik gösterebilir.
* Malzeme kalınlık toleransı ± %10 dur.
* Lütfen siparişlerinizde sipariş kodu veya ürün kodu ve Kaplama şeklini belirtiniz.

* We can produce cable trays different thickness and dimensions
* Cable trays are shown approximately weight, they could change ± %10 difference.
* Cable trays thickness tolerances are shown ± %10 .
* Please indicate order code and coating type in your orders.

AGH SERIES

DÖRTLÜ BAGLANTI R300 (MODEL1)

FOUR WAY CROSSING R300 (MODEL1)

PREGALVANİZ (PG)
PREGALVANİZ (PG)
TS EN 10346



H40 = H50 Tek delikli
H40 = H50 One hole



H40

Sipariş Kodu Order Code	W (mm)	T (mm)	Ağırlık (kg/ad) Weight (kg/pcs)	Barkod Kodu Barcode Code
40 AGH 050D	50	1.20 mm	0,326	2001300
40 AGH 100D	100	1.20 mm	0,812	2001301
40 AGH 120D	120	1.20 mm	0,975	2001302
40 AGH 160D	160	1.20 mm	0,996	2001303
40 AGH 200D	200	1.20 mm	1,322	2001304
40 AGH 300D	300	1.20 mm	2,037	2001305
40 AGH 400D	400	1.50 mm	3,931	2001306
40 AGH 500D	500	1.50 mm	5,412	2001307
40 AGH 600D	600	1.50 mm	7,169	2001308

H50

Sipariş Kodu Order Code	W (mm)	T (mm)	Ağırlık (kg/ad) Weight (kg/pcs)	Barkod Kodu Barcode Code
50 AGH 050D	50	1.20 mm	0,369	2001309
50 AGH 100D	100	1.20 mm	0,894	2001310
50 AGH 160D	160	1.20 mm	0,982	2001311
50 AGH 200D	200	1.20 mm	1,407	2001312
50 AGH 300D	300	1.20 mm	2,119	2001313
50 AGH 400D	400	1.50 mm	4,036	2001314
50 AGH 500D	500	1.50 mm	5,529	2001315
50 AGH 600D	600	1.50 mm	7,278	2001316

H60

Sipariş Kodu Order Code	W (mm)	T (mm)	Ağırlık (kg/ad) Weight (kg/pcs)	Barkod Kodu Barcode Code
60 AGH 100D	100	1.20 mm	0,972	2001317
60 AGH 160D	160	1.20 mm	1,143	2001318
60 AGH 200D	200	1.20 mm	1,489	2001319
60 AGH 300D	300	1.20 mm	2,197	2001320
60 AGH 400D	400	1.50 mm	4,148	2001321
60 AGH 500D	500	1.50 mm	5,638	2001322
60 AGH 600D	600	1.50 mm	7,387	2001323

H100

Sipariş Kodu Order Code	W (mm)	T (mm)	Ağırlık (kg/ad) Weight (kg/pcs)	Barkod Kodu Barcode Code
100 AGH 100D	100	1.20 mm	1,256	2001324
100 AGH 160D	160	1.20 mm	1,400	2001325
100 AGH 200D	200	1.20 mm	1,765	2001326
100 AGH 300D	300	1.20 mm	2,481	2001327
100 AGH 400D	400	1.50 mm	4,518	2001328
100 AGH 500D	500	1.50 mm	6,003	2001329
100 AGH 600D	600	1.50 mm	7,761	2001330

H = YÜKSEKLİK = HEIGHT / W = GENİŞLİK = WIDTH / T = KALINLIK = THICKNESS

H AGH 100 D

Yükseklik Kanal Tipi Genişlik Modül
Height Type Width Module

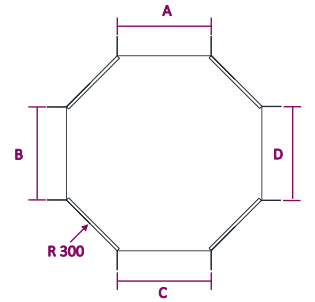
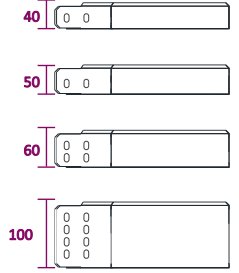

Dönüşlerde "A-B-C-D" ölçüleri esit olarak üretilmektedir. İsteğe bağlı olarak farklı ölçülerde üretim yapılır. Bends are produced same dimension for "A-B-C-D" as well as we can produce special dimensions regarding your inquiry.

ARTIM METAL ELEKTRİK A.Ş.

* Farklı kalınlık ve ölçülerde üretim yapılabılır.
* Malzeme ağırlıkları yaklaşık değerlerdir, ± %10 değişiklik gösterebilir.
* Malzeme kalınlık toleransı ± %10 dur.
* Lütfen siparişlerinizde sipariş kodu veya ürün kodu ve Kaplama şeklini belirtiniz.

* We can produce cable trays different thickness and dimensions
* Cable trays are shown approximately weight, they could change ± %10 difference.
* Cable trays thickness tolerances are shown ± %10 .
* Please indicate order code and coating type in your orders.

AGH SERIES

DÖRTLÜ BAGLANTI R300 (MODEL1)

FOUR WAY CROSSING R300 (MODEL1)

SICAK DALDIRMA (SD)

HOT DIP GALVANIZED (HDG)

TS EN ISO 1461



H40 = H50 Tek delikli
H40 = H50 One hole

H40

Sipariş Kodu Order Code	W (mm)	T (mm)	Ağırlık (kg/ad) Weight (kg/pcs)	Barkod Kodu Barcode Code
40 AGH 050D	50	1.50 mm	0,445	2001300
40 AGH 100D	100	1.50 mm	1,106	2001301
40 AGH 120D	120	1.50 mm	1,230	2001302
40 AGH 160D	160	1.50 mm	1,354	2001303
40 AGH 200D	200	1.50 mm	1,799	2001304
40 AGH 300D	300	1.50 mm	2,773	2001305
40 AGH 400D	400	2.00 mm	5,350	2001306
40 AGH 500D	500	2.00 mm	7,367	2001307
40 AGH 600D	600	2.00 mm	9,759	2001308

H50

Sipariş Kodu Order Code	W (mm)	T (mm)	Ağırlık (kg/ad) Weight (kg/pcs)	Barkod Kodu Barcode Code
50 AGH 050D	50	1.50 mm	0,503	2001309
50 AGH 100D	100	1.50 mm	1,217	2001310
50 AGH 160D	160	1.50 mm	1,456	2001311
50 AGH 200D	200	1.50 mm	1,916	2001312
50 AGH 300D	300	1.50 mm	2,885	2001313
50 AGH 400D	400	2.00 mm	5,493	2001314
50 AGH 500D	500	2.00 mm	7,525	2001315
50 AGH 600D	600	2.00 mm	9,907	2001316

H60

Sipariş Kodu Order Code	W (mm)	T (mm)	Ağırlık (kg/ad) Weight (kg/pcs)	Barkod Kodu Barcode Code
60 AGH 100D	100	1.50 mm	1,323	2001317
60 AGH 160D	160	1.50 mm	1,556	2001318
60 AGH 200D	200	1.50 mm	2,027	2001319
60 AGH 300D	300	1.50 mm	2,991	2001320
60 AGH 400D	400	2.00 mm	5,646	2001321
60 AGH 500D	500	2.00 mm	7,673	2001322
60 AGH 600D	600	2.00 mm	10,055	2001323

H100

Sipariş Kodu Order Code	W (mm)	T (mm)	Ağırlık (kg/ad) Weight (kg/pcs)	Barkod Kodu Barcode Code
100 AGH 100D	100	1.50 mm	1,710	2001324
100 AGH 160D	160	1.50 mm	1,905	2001325
100 AGH 200D	200	1.50 mm	2,403	2001326
100 AGH 300D	300	1.50 mm	3,376	2001327
100 AGH 400D	400	2.00 mm	6,150	2001328
100 AGH 500D	500	2.00 mm	8,171	2001329
100 AGH 600D	600	2.00 mm	10,562	2001330

H = YÜKSEKLİK = HEIGHT / W = GENİŞLİK = WIDTH / T = KALINLIK = THICKNESS

H AGH 100 D

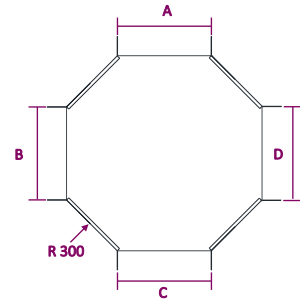
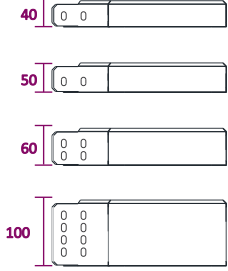

Dönüşlerde "A-B-C-D" ölçüleri esit olarak üretilmektedir. İsteğe bağlı olarak farklı ölçülerde üretim yapılır.

Bends are produced same dimension for "A-B-C-D" as well as we can produce special dimensions regarding your inquiry.

* Farklı kalınlık ve ölçülerde üretim yapılabılır.
* Malzeme ağırlıkları yaklaşık değerlerdir, ± %10 değişiklik gösterebilir.
* Malzeme kalınlık toleransı ± %10 dur.
* Lütfen siparişlerinizde sipariş kodu veya ürün kodu ve Kaplama şeklini belirtiniz.

* We can produce cable trays different thickness and dimensions
* Cable trays are shown approximately weight, they could change ± %10 difference.
* Cable trays thickness tolerances are shown ± %10 .
* Please indicate order code and coating type in your orders.

AGH SERIES

DÖRTLÜ BAGLANTI R450 (MODEL1)

FOUR WAY CROSSING R450 (MODEL1)

PREGALVANİZ (PG)
PREGALVANİZ (PG)
TS EN 10346



H40 = H50 Tek delikli
H40 = H50 One hole



H40

Sipariş Kodu Order Code	W (mm)	T (mm)	Ağırlık (kg/ad) Weight (kg/pcs)	Barkod Kodu Barcode Code
40 AGH 050D	50	1.20 mm	0,391	2001300
40 AGH 100D	100	1.20 mm	0,975	2001301
40 AGH 120D	120	1.20 mm	1,170	2001302
40 AGH 160D	160	1.20 mm	1,195	2001303
40 AGH 200D	200	1.20 mm	1,586	2001304
40 AGH 300D	300	1.20 mm	2,444	2001305
40 AGH 400D	400	1.50 mm	4,717	2001306
40 AGH 500D	500	1.50 mm	6,494	2001307
40 AGH 600D	600	1.50 mm	8,603	2001308

H50

Sipariş Kodu Order Code	W (mm)	T (mm)	Ağırlık (kg/ad) Weight (kg/pcs)	Barkod Kodu Barcode Code
50 AGH 050D	50	1.20 mm	0,443	2001309
50 AGH 100D	100	1.20 mm	1,073	2001310
50 AGH 160D	160	1.20 mm	1,178	2001311
50 AGH 200D	200	1.20 mm	1,689	2001312
50 AGH 300D	300	1.20 mm	2,543	2001313
50 AGH 400D	400	1.50 mm	4,843	2001314
50 AGH 500D	500	1.50 mm	6,634	2001315
50 AGH 600D	600	1.50 mm	8,734	2001316

H60

Sipariş Kodu Order Code	W (mm)	T (mm)	Ağırlık (kg/ad) Weight (kg/pcs)	Barkod Kodu Barcode Code
60 AGH 100D	100	1.20 mm	1,166	2001317
60 AGH 160D	160	1.20 mm	1,371	2001318
60 AGH 200D	200	1.20 mm	1,787	2001319
60 AGH 300D	300	1.20 mm	2,636	2001320
60 AGH 400D	400	1.50 mm	4,978	2001321
60 AGH 500D	500	1.50 mm	6,765	2001322
60 AGH 600D	600	1.50 mm	8,865	2001323

H100

Sipariş Kodu Order Code	W (mm)	T (mm)	Ağırlık (kg/ad) Weight (kg/pcs)	Barkod Kodu Barcode Code
100 AGH 100D	100	1.20 mm	1,507	2001324
100 AGH 160D	160	1.20 mm	1,680	2001325
100 AGH 200D	200	1.20 mm	2,118	2001326
100 AGH 300D	300	1.20 mm	2,977	2001327
100 AGH 400D	400	1.50 mm	5,421	2001328
100 AGH 500D	500	1.50 mm	7,203	2001329
100 AGH 600D	600	1.50 mm	9,313	2001330

H = YÜKSEKLİK = HEIGHT / W = GENİŞLİK = WIDTH / T = KALINLIK = THICKNESS

H AGH 100 D

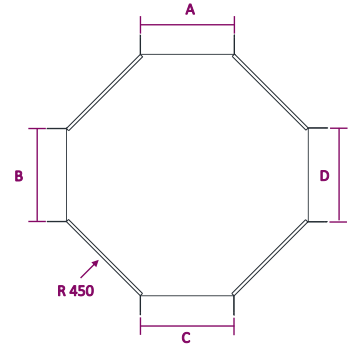
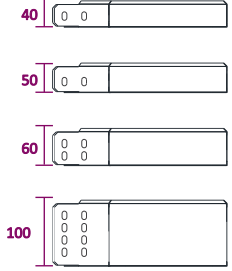

Dönüşlerde "A-B-C-D" ölçüleri esit olarak üretilmektedir. İsteğe bağlı olarak farklı ölçülerde üretim yapılır. Bends are produced same dimension for "A-B-C-D" as well as we can produce special dimensions regarding your inquiry.

ARTIM METAL ELEKTRİK A.Ş.

* Farklı kalınlık ve ölçülerde üretim yapılabılır.
* Malzeme ağırlıkları yaklaşık değerlerdir, ± %10 değişiklik gösterebilir.
* Malzeme kalınlık toleransı ± %10 dur.
* Lütfen siparişlerinizde sipariş kodu veya ürün kodu ve Kaplama şeklini belirtiniz.

* We can produce cable trays different thickness and dimensions
* Cable trays are shown approximately weight, they could change ± %10 difference.
* Cable trays thickness tolerances are shown ± %10 .
* Please indicate order code and coating type in your orders.

AGH SERIES

DÖRTLÜ BAGLANTI R450 (MODEL1)

FOUR WAY CROSSING R450 (MODEL1)

SICAK DALDIRMA (SD)

HOT DIP GALVANIZED (SD)

TS EN ISO 1461



H40 = H50 Tek delikli
H40 = H50 One hole



H40

Sipariş Kodu Order Code	W (mm)	T (mm)	Ağırlık (kg/ad) Weight (kg/pcs)	Barkod Kodu Barcode Code
40 AGH 050D	50	1.50 mm	0,534	2001300
40 AGH 100D	100	1.50 mm	1,327	2001301
40 AGH 120D	120	1.50 mm	1,476	2001302
40 AGH 160D	160	1.50 mm	1,625	2001303
40 AGH 200D	200	1.50 mm	2,159	2001304
40 AGH 300D	300	1.50 mm	3,328	2001305
40 AGH 400D	400	2.00 mm	6,420	2001306
40 AGH 500D	500	2.00 mm	8,840	2001307
40 AGH 600D	600	2.00 mm	11,711	2001308

H50

Sipariş Kodu Order Code	W (mm)	T (mm)	Ağırlık (kg/ad) Weight (kg/pcs)	Barkod Kodu Barcode Code
50 AGH 050D	50	1.50 mm	0,604	2001309
50 AGH 100D	100	1.50 mm	1,461	2001310
50 AGH 160D	160	1.50 mm	1,747	2001311
50 AGH 200D	200	1.50 mm	2,299	2001312
50 AGH 300D	300	1.50 mm	3,462	2001313
50 AGH 400D	400	2.00 mm	6,591	2001314
50 AGH 500D	500	2.00 mm	9,031	2001315
50 AGH 600D	600	2.00 mm	11,888	2001316

H60

Sipariş Kodu Order Code	W (mm)	T (mm)	Ağırlık (kg/ad) Weight (kg/pcs)	Barkod Kodu Barcode Code
60 AGH 100D	100	1.50 mm	1,588	2001317
60 AGH 160D	160	1.50 mm	1,868	2001318
60 AGH 200D	200	1.50 mm	2,433	2001319
60 AGH 300D	300	1.50 mm	3,589	2001320
60 AGH 400D	400	2.00 mm	6,775	2001321
60 AGH 500D	500	2.00 mm	9,208	2001322
60 AGH 600D	600	2.00 mm	12,066	2001323

H100

Sipariş Kodu Order Code	W (mm)	T (mm)	Ağırlık (kg/ad) Weight (kg/pcs)	Barkod Kodu Barcode Code
100 AGH 100D	100	1.50 mm	2,052	2001324
100 AGH 160D	160	1.50 mm	2,286	2001325
100 AGH 200D	200	1.50 mm	2,884	2001326
100 AGH 300D	300	1.50 mm	4,051	2001327
100 AGH 400D	400	2.00 mm	7,379	2001328
100 AGH 500D	500	2.00 mm	9,806	2001329
100 AGH 600D	600	2.00 mm	12,675	2001330

H = YÜKSEKLİK = HEIGHT / W = GENİŞLİK = WIDTH / T = KALINLIK = THICKNESS

H AGH 100 D

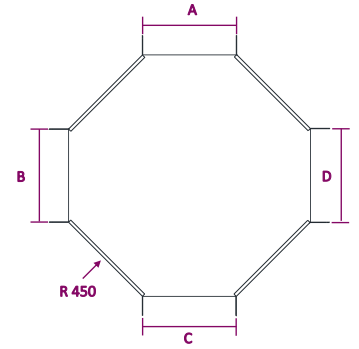
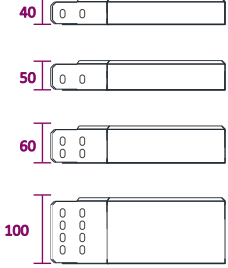

Dönüşlerde "A-B-C-D" ölçüleri esit olarak üretilmektedir. İsteğe bağlı olarak farklı ölçülerde üretim yapılır.

Bends are produced same dimension for "A-B-C-D" as well as we can produce special dimensions regarding your inquiry.

* Farklı kalınlık ve ölçülerde üretim yapılabılır.
* Malzeme ağırlıkları yaklaşık değerlerdir, \pm %10 değişiklik gösterebilir.
* Malzeme kalınlık toleransı \pm %10 dur.
* Lütfen siparişlerinizde sipariş kodu veya ürün kodu ve kaplama şeklini belirtiniz.

* We can produce cable trays different thickness and dimensions
* Cable trays are shown approximately weight, they could change \pm %10 difference.
* Cable trays thickness tolerances are shown \pm %10 .
* Please indicate order code and coating type in your orders.

AGH SERIES

DÖRTLÜ BAGLANTI R600 (MODEL1)

FOUR WAY CROSSING R600 (MODEL1)

PREGALVANİZ (PG)
PREGALVANİZ (PG)
TS EN 10346



H40 = H50 Tek delikli
H40 = H50 One hole



H40

Sipariş Kodu Order Code	W (mm)	T (mm)	Ağırlık (kg/ad) Weight (kg/pcs)	Barkod Kodu Barcode Code
40 AGH 050D	50	1.20 mm	0,454	2001300
40 AGH 100D	100	1.20 mm	1,131	2001301
40 AGH 120D	120	1.20 mm	1,358	2001302
40 AGH 160D	160	1.20 mm	1,386	2001303
40 AGH 200D	200	1.20 mm	1,840	2001304
40 AGH 300D	300	1.20 mm	2,835	2001305
40 AGH 400D	400	1.50 mm	5,472	2001306
40 AGH 500D	500	1.50 mm	7,533	2001307
40 AGH 600D	600	1.50 mm	9,979	2001308

H50

Sipariş Kodu Order Code	W (mm)	T (mm)	Ağırlık (kg/ad) Weight (kg/pcs)	Barkod Kodu Barcode Code
50 AGH 050D	50	1.20 mm	0,514	2001309
50 AGH 100D	100	1.20 mm	1,245	2001310
50 AGH 160D	160	1.20 mm	1,367	2001311
50 AGH 200D	200	1.20 mm	1,959	2001312
50 AGH 300D	300	1.20 mm	2,950	2001313
50 AGH 400D	400	1.50 mm	5,618	2001314
50 AGH 500D	500	1.50 mm	7,696	2001315
50 AGH 600D	600	1.50 mm	10,131	2001316

H60

Sipariş Kodu Order Code	W (mm)	T (mm)	Ağırlık (kg/ad) Weight (kg/pcs)	Barkod Kodu Barcode Code
60 AGH 100D	100	1.20 mm	1,353	2001317
60 AGH 160D	160	1.20 mm	1,591	2001318
60 AGH 200D	200	1.20 mm	2,073	2001319
60 AGH 300D	300	1.20 mm	3,058	2001320
60 AGH 400D	400	1.50 mm	5,774	2001321
60 AGH 500D	500	1.50 mm	7,848	2001322
60 AGH 600D	600	1.50 mm	10,283	2001323

H100

Sipariş Kodu Order Code	W (mm)	T (mm)	Ağırlık (kg/ad) Weight (kg/pcs)	Barkod Kodu Barcode Code
100 AGH 100D	100	1.20 mm	1,748	2001324
100 AGH 160D	160	1.20 mm	1,948	2001325
100 AGH 200D	200	1.20 mm	2,456	2001326
100 AGH 300D	300	1.20 mm	3,453	2001327
100 AGH 400D	400	1.50 mm	6,289	2001328
100 AGH 500D	500	1.50 mm	8,356	2001329
100 AGH 600D	600	1.50 mm	10,803	2001330

H = YÜKSEKLİK = HEIGHT / W = GENİŞLİK = WIDTH / T = KALINLIK = THICKNESS

H AGH 100 D

Yükseklik Kanal Tipi Genişlik Modül
Height Type Width Module

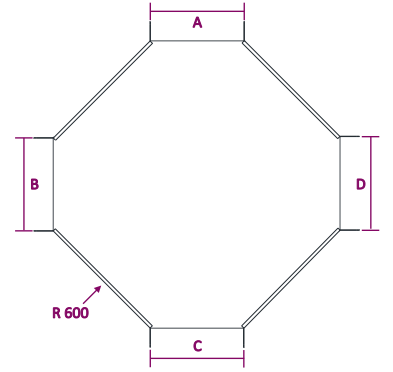
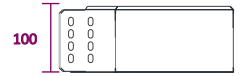
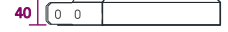

Dönüşlerde "A-B-C-D" ölçüleri esit olarak üretilmektedir. İsteğe bağlı olarak farklı ölçülerde üretim yapılır.

Bends are produced same dimension for "A-B-C-D" as well as we can produce special dimensions regarding your inquiry.

ARTIM METAL ELEKTRİK A.Ş.

* Farklı kalınlık ve ölçülerde üretim yapılabılır.
* Malzeme ağırlıkları yaklaşık değerlerdir, ± %10 değişiklik gösterebilir.
* Malzeme kalınlık toleransı ± %10 dur.
* Lütfen siparişlerinizde sipariş kodu veya ürün kodu ve Kaplama şeklini belirtiniz.

* We can produce cable trays different thickness and dimensions
* Cable trays are shown approximately weight, they could change ± %10 difference.
* Cable trays thickness tolerances are shown ± %10 .
* Please indicate order code and coating type in your orders.

AGH SERIES

DÖRTLÜ BAGLANTI R600 (MODEL1)

FOUR WAY CROSSING R600 (MODEL1)

SICAK DALDIRMA (SD)

HOT DIP GALVANIZED (SD)

TS EN ISO 1461



Sipariş Kodu Order Code	W (mm)	T (mm)	Ağırlık (kg/ad) Weight (kg/pcs)	Barkod Kodu Barcode Code
40 AGH 050D	50	1.50 mm	0,619	2001300
40 AGH 100D	100	1.50 mm	1,539	2001301
40 AGH 120D	120	1.50 mm	1,712	2001302
40 AGH 160D	160	1.50 mm	1,885	2001303
40 AGH 200D	200	1.50 mm	2,505	2001304
40 AGH 300D	300	1.50 mm	3,861	2001305
40 AGH 400D	400	2.00 mm	7,448	2001306
40 AGH 500D	500	2.00 mm	10,254	2001307
40 AGH 600D	600	2.00 mm	13,584	2001308

H40

H AGH 100 D

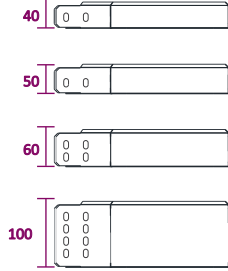

H40 = H50 Tek delikli
H40 = H50 One hole

Sipariş Kodu Order Code	W (mm)	T (mm)	Ağırlık (kg/ad) Weight (kg/pcs)	Barkod Kodu Barcode Code
50 AGH 050D	50	1.50 mm	0,701	2001309
50 AGH 100D	100	1.50 mm	1,694	2001310
50 AGH 160D	160	1.50 mm	2,027	2001311
50 AGH 200D	200	1.50 mm	2,667	2001312
50 AGH 300D	300	1.50 mm	4,015	2001313
50 AGH 400D	400	2.00 mm	7,646	2001314
50 AGH 500D	500	2.00 mm	10,475	2001315
50 AGH 600D	600	2.00 mm	13,790	2001316

H50

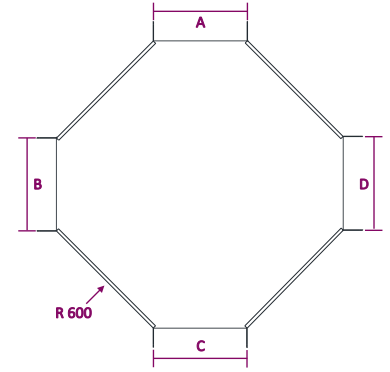

Dönüşlerde "A-B-C-D" ölçüleri esit olarak üretilmektedir. İsteğe bağlı olarak farklı ölçülerde üretim yapılır.

Bends are produced same dimension for "A-B-C-D" as well as we can produce special dimensions regarding your inquiry.

Sipariş Kodu Order Code	W (mm)	T (mm)	Ağırlık (kg/ad) Weight (kg/pcs)	Barkod Kodu Barcode Code
60 AGH 100D	100	1.50 mm	1,842	2001317
60 AGH 160D	160	1.50 mm	2,166	2001318
60 AGH 200D	200	1.50 mm	2,822	2001319
60 AGH 300D	300	1.50 mm	4,163	2001320
60 AGH 400D	400	2.00 mm	7,860	2001321
60 AGH 500D	500	2.00 mm	10,681	2001322
60 AGH 600D	600	2.00 mm	13,996	2001323

H60

Sipariş Kodu Order Code	W (mm)	T (mm)	Ağırlık (kg/ad) Weight (kg/pcs)	Barkod Kodu Barcode Code
100 AGH 100D	100	1.50 mm	2,380	2001324
100 AGH 160D	160	1.50 mm	2,652	2001325
100 AGH 200D	200	1.50 mm	3,345	2001326
100 AGH 300D	300	1.50 mm	4,700	2001327
100 AGH 400D	400	2.00 mm	8,560	2001328
100 AGH 500D	500	2.00 mm	11,374	2001329
100 AGH 600D	600	2.00 mm	14,703	2001330

H100

H = YÜKSEKLİK = HEIGHT / W = GENİŞLİK = WIDTH / T = KALINLIK = THICKNESS



* Farklı kalınlık ve ölçülerde üretim yapılabilir.
* Malzeme ağırlıkları yaklaşık değerlerdir, ± %10 değişiklik gösterebilir.
* Malzeme kalınlık toleransı ± %10 dur.
* Lütfen siparişlerinizde sipariş kodu veya ürün kodu ve kaplama şeklini belirtiniz.

* We can produce cable trays different thickness and dimensions
* Cable trays are shown approximately weight, they could change ± %10 difference.
* Cable trays thickness tolerances are shown ± %10 .
* Please indicate order code and coating type in your orders.

AGH SERIES

45° YATAY DÖNÜS

45° BEND

PREGALVANİZ (PG)
PREGALVANİZ (PG)
TS EN 10346



H40 = H50 Tek delikli
H40 = H50 One hole
H60 = Çift delikli
H60 = Double hole
H100 = Dört delikli
H100 = Four holes

H40

Sipariş Kodu Order Code	W (mm)	T (mm)	Ağırlık (kg/ad) Weight (kg/pcs)	Barkod Kodu Barcode Code
40 AGH 050Y (45°)	50	1.20 mm	0,616	2001150
40 AGH 100Y (45°)	100	1.20 mm	0,767	2001151
40 AGH 120Y (45°)	120	1.20 mm	0,804	2001152
40 AGH 160Y (45°)	160	1.20 mm	0,878	2001153
40 AGH 200Y (45°)	200	1.20 mm	1,112	2001154
40 AGH 300Y (45°)	300	1.20 mm	2,336	2001155
40 AGH 400Y (45°)	400	1.50 mm	4,050	2001156
40 AGH 500Y (45°)	500	1.50 mm	5,069	2001157
40 AGH 600Y (45°)	600	1.50 mm	6,206	2001158

H50

Sipariş Kodu Order Code	W (mm)	T (mm)	Ağırlık (kg/ad) Weight (kg/pcs)	Barkod Kodu Barcode Code
50 AGH 050Y (45°)	50	1.20 mm	0,702	2001159
50 AGH 100Y (45°)	100	1.20 mm	0,853	2001160
50 AGH 160Y (45°)	160	1.20 mm	0,965	2001161
50 AGH 200Y (45°)	200	1.20 mm	1,213	2001162
50 AGH 300Y (45°)	300	1.20 mm	2,484	2001163
50 AGH 400Y (45°)	400	1.50 mm	4,241	2001164
50 AGH 500Y (45°)	500	1.50 mm	5,288	2001165
50 AGH 600Y (45°)	600	1.50 mm	6,430	2001166

H60

Sipariş Kodu Order Code	W (mm)	T (mm)	Ağırlık (kg/ad) Weight (kg/pcs)	Barkod Kodu Barcode Code
60 AGH 100Y (45°)	100	1.20 mm	0,947	2001167
60 AGH 160Y (45°)	160	1.20 mm	1,051	2001168
60 AGH 200Y (45°)	200	1.20 mm	1,318	2001169
60 AGH 300Y (45°)	300	1.20 mm	2,412	2001170
60 AGH 400Y (45°)	400	1.50 mm	4,450	2001171
60 AGH 500Y (45°)	500	1.50 mm	5,494	2001172
60 AGH 600Y (45°)	600	1.50 mm	6,649	2001173

H100

Sipariş Kodu Order Code	W (mm)	T (mm)	Ağırlık (kg/ad) Weight (kg/pcs)	Barkod Kodu Barcode Code
100 AGH 100Y (45°)	100	1.20 mm	1,285	2001174
100 AGH 160Y (45°)	160	1.20 mm	1,375	2001175
100 AGH 200Y (45°)	200	1.20 mm	1,681	2001176
100 AGH 300Y (45°)	300	1.20 mm	3,168	2001177
100 AGH 400Y (45°)	400	1.50 mm	5,224	2001178
100 AGH 500Y (45°)	500	1.50 mm	6,314	2001179
100 AGH 600Y (45°)	600	1.50 mm	7,506	2001180

H = YÜKSEKLİK = HEIGHT / W = GENİŞLİK = WIDTH / T = KALINLIK = THICKNESS

H AGH 100Y (45°)

Yükseklik Kanal Tipi Genişlik Modül
Height Type Width Module

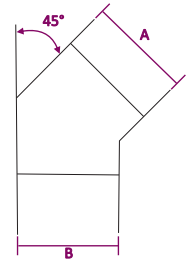

ARTIM METAL ELEKTRİK A.Ş.

* Farklı kalınlık ve ölçülerde üretim yapılabılır.
* Malzeme ağırlıkları yaklaşık değerlerdir, \pm %10 değişiklik gösterebilir.
* Malzeme kalınlık toleransı \pm %10 dur.
* Lütfen siparişlerinizde sipariş kodu veya ürün kodu ve Kaplama şeklini belirtiniz.

* We can produce cable trays different thickness and dimensions
* Cable trays are shown approximately weight, they could change \pm %10 difference.
* Cable trays thickness tolerances are shown \pm %10 .
* Please indicate order code and coating type in your orders.

AGH SERIES

45° YATAY DÖNÜS

45° BEND

SICAK DALDIRMA (SD)

HOT DIP GALVANIZED (SD)

TS EN ISO 1461



H40 = H50 Tek delikli
H40 = H50 One hole

H60 = Çift delikli
H60 = Double hole

H100 = Dört delikli
H100 = Four holes



H40

Sipariş Kodu Order Code	W (mm)	T (mm)	Ağırlık (kg/ad) Weight (kg/pcs)	Barkod Kodu Barcode Code
40 AGH 050Y (45°)	50	1.50 mm	0,838	2001150
40 AGH 100Y (45°)	100	1.50 mm	1,044	2001151
40 AGH 120Y (45°)	120	1.50 mm	1,120	2001152
40 AGH 160Y (45°)	160	1.50 mm	1,196	2001153
40 AGH 200Y (45°)	200	1.50 mm	1,514	2001154
40 AGH 300Y (45°)	300	1.50 mm	3,180	2001155
40 AGH 400Y (45°)	400	2.00 mm	5,513	2001156
40 AGH 500Y (45°)	500	2.00 mm	6,899	2001157
40 AGH 600Y (45°)	600	2.00 mm	8,448	2001158

H50

Sipariş Kodu Order Code	W (mm)	T (mm)	Ağırlık (kg/ad) Weight (kg/pcs)	Barkod Kodu Barcode Code
50 AGH 050Y (45°)	50	1.50 mm	0,956	2001159
50 AGH 100Y (45°)	100	1.50 mm	1,161	2001160
50 AGH 160Y (45°)	160	1.50 mm	1,313	2001161
50 AGH 200Y (45°)	200	1.50 mm	1,651	2001162
50 AGH 300Y (45°)	300	1.50 mm	3,381	2001163
50 AGH 400Y (45°)	400	2.00 mm	5,772	2001164
50 AGH 500Y (45°)	500	2.00 mm	7,198	2001165
50 AGH 600Y (45°)	600	2.00 mm	8,751	2001166

H60

Sipariş Kodu Order Code	W (mm)	T (mm)	Ağırlık (kg/ad) Weight (kg/pcs)	Barkod Kodu Barcode Code
60 AGH 100Y (45°)	100	1.50 mm	1,289	2001167
60 AGH 160Y (45°)	160	1.50 mm	1,431	2001168
60 AGH 200Y (45°)	200	1.50 mm	1,793	2001169
60 AGH 300Y (45°)	300	1.50 mm	3,283	2001170
60 AGH 400Y (45°)	400	2.00 mm	6,056	2001171
60 AGH 500Y (45°)	500	2.00 mm	7,477	2001172
60 AGH 600Y (45°)	600	2.00 mm	9,050	2001173

H100

Sipariş Kodu Order Code	W (mm)	T (mm)	Ağırlık (kg/ad) Weight (kg/pcs)	Barkod Kodu Barcode Code
100 AGH 100Y (45°)	100	1.50 mm	1,794	2001174
100 AGH 160Y (45°)	160	1.50 mm	1,872	2001175
100 AGH 200Y (45°)	200	1.50 mm	2,288	2001176
100 AGH 300Y (45°)	300	1.50 mm	4,312	2001177
100 AGH 400Y (45°)	400	2.00 mm	7,110	2001178
100 AGH 500Y (45°)	500	2.00 mm	8,595	2001179
100 AGH 600Y (45°)	600	2.00 mm	10,217	2001180

H = YÜKSEKLİK = HEIGHT / W = GENİŞLİK = WIDTH / T = KALINLIK = THICKNESS

H AGH 100Y (45°)

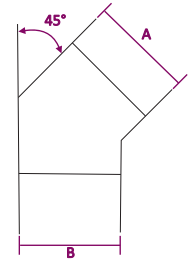
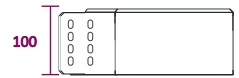

* Farklı kalınlık ve ölçülerde üretim yapılabılır.
* Malzeme ağırlıkları yaklaşık değerlerdir, ± %10 değişiklik gösterebilir.
* Malzeme kalınlık toleransı ± %10 dur.
* Lütfen siparişlerinizde sipariş kodu veya ürün kodu ve Kaplama şeklini belirtiniz.

* We can produce cable trays different thickness and dimensions
* Cable trays are shown approximately weight, they could change ± %10 difference.
* Cable trays thickness tolerances are shown ± %10 .
* Please indicate order code and coating type in your orders.

AGH SERIES

YARIM T BAĞLANTI

ADD-ON TEES

PREGALVANİZ (PG)
PREGALVANIZED (PG)
TS EN 10346

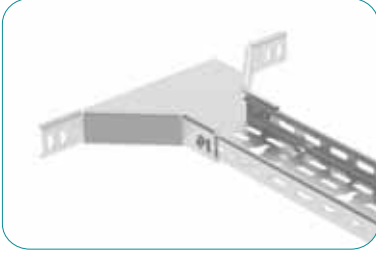

H40

Sipariş Kodu Order Code	W (mm)	T (mm)	Ağırlık (kg/ad) Weight (kg/pcs)	Barkod Kodu Barcode Code
40 AGH 100TT	100	1.20 mm	0,354	2001800
40 AGH 160TT	160	1.20 mm	0,781	2001801
40 AGH 200TT	200	1.20 mm	0,678	2001802
40 AGH 300TT	300	1.20 mm	1,195	2001803
40 AGH 400TT	400	1.50 mm	3,929	2001804
40 AGH 500TT	500	1.50 mm	3,996	2001805
40 AGH 600TT	600	1.50 mm	5,474	2001806

H50

Sipariş Kodu Order Code	W (mm)	T (mm)	Ağırlık (kg/ad) Weight (kg/pcs)	Barkod Kodu Barcode Code
50 AGH 100TT	100	1.20 mm	0,426	2001807
50 AGH 160TT	160	1.20 mm	0,552	2001808
50 AGH 200TT	200	1.20 mm	0,764	2001809
50 AGH 300TT	300	1.20 mm	1,285	2001810
50 AGH 400TT	400	1.50 mm	2,892	2001811
50 AGH 500TT	500	1.50 mm	4,136	2001812
50 AGH 600TT	600	1.50 mm	5,629	2001813

H60

Sipariş Kodu Order Code	W (mm)	T (mm)	Ağırlık (kg/ad) Weight (kg/pcs)	Barkod Kodu Barcode Code
60 AGH 100TT	100	1.20 mm	0,495	2001814
60 AGH 160TT	160	1.20 mm	0,620	2001815
60 AGH 200TT	200	1.20 mm	0,840	2001816
60 AGH 300TT	300	1.20 mm	1,371	2001817
60 AGH 400TT	400	1.50 mm	3,029	2001818
60 AGH 500TT	500	1.50 mm	4,280	2001819
60 AGH 600TT	600	1.50 mm	5,783	2001820

H100

Sipariş Kodu Order Code	W (mm)	T (mm)	Ağırlık (kg/ad) Weight (kg/pcs)	Barkod Kodu Barcode Code
100 AGH 100TT	100	1.20 mm	0,736	2001821
100 AGH 160TT	160	1.20 mm	0,861	2001822
100 AGH 200TT	200	1.20 mm	1,121	2001823
100 AGH 300TT	300	1.20 mm	1,688	2001824
100 AGH 400TT	400	1.50 mm	3,371	2001825
100 AGH 500TT	500	1.50 mm	4,673	2001826
100 AGH 600TT	600	1.50 mm	6,233	2001827

H = YÜKSEKLİK = HEIGHT / W = GENİŞLİK = WIDTH / T = KALINLIK = THICKNESS

H AGH 100 TT

Yükseklik Kanal Tipi Genişlik Modül
Height Type Width Module

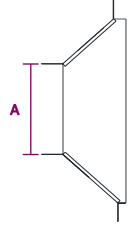
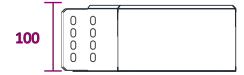
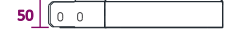

ARTIM METAL ELEKTRİK A.Ş.

- * Farklı kalınlık ve ölçülerde üretim yapılabılır.
- * Malzeme ağırlıkları yaklaşık değerlerdir, \pm %10 değişiklik gösterebilir.
- * Malzeme kalınlık toleransı \pm %10 dur.
- * Lütfen siparişlerinizde sipariş kodu veya ürün kodu ve Kaplama şeklini belirtiniz.

- * We can produce cable trays different thickness and dimensions
- * Cable trays are shown approximately weight, they could change \pm %10 difference.
- * Cable trays thickness tolerances are shown \pm %10 .
- * Please indicate order code and coating type in your orders.

AGH SERIES

YARIM T BAĞLANTI

ADD-ON TEES

SICAK DALDIRMA (SD)

HOT DIP GALVANIZED (SD)

TS EN ISO 1461

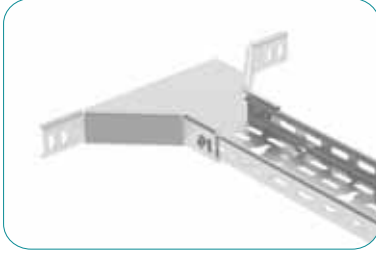

H40

Sipariş Kodu Order Code	W (mm)	T (mm)	Ağırlık (kg/ad) Weight (kg/pcs)	Barkod Kodu Barcode Code
40 AGH 100TT	100	1.50 mm	0,558	2001800
40 AGH 160TT	160	1.50 mm	0,747	2001801
40 AGH 200TT	200	1.50 mm	1,038	2001802
40 AGH 300TT	300	1.50 mm	1,781	2001803
40 AGH 400TT	400	2.00 mm	5,539	2001804
40 AGH 500TT	500	2.00 mm	5,669	2001805
40 AGH 600TT	600	2.00 mm	7,721	2001806

H50

Sipariş Kodu Order Code	W (mm)	T (mm)	Ağırlık (kg/ad) Weight (kg/pcs)	Barkod Kodu Barcode Code
50 AGH 100TT	100	1.50 mm	0,656	2001807
50 AGH 160TT	160	1.50 mm	0,840	2001808
50 AGH 200TT	200	1.50 mm	1,156	2001809
50 AGH 300TT	300	1.50 mm	1,903	2001810
50 AGH 400TT	400	2.00 mm	4,128	2001811
50 AGH 500TT	500	2.00 mm	5,861	2001812
50 AGH 600TT	600	2.00 mm	7,932	2001813

H60

Sipariş Kodu Order Code	W (mm)	T (mm)	Ağırlık (kg/ad) Weight (kg/pcs)	Barkod Kodu Barcode Code
60 AGH 100TT	100	1.50 mm	0,749	2001814
60 AGH 160TT	160	1.50 mm	0,933	2001815
60 AGH 200TT	200	1.50 mm	1,259	2001816
60 AGH 300TT	300	1.50 mm	2,021	2001817
60 AGH 400TT	400	2.00 mm	4,314	2001818
60 AGH 500TT	500	2.00 mm	6,057	2001819
60 AGH 600TT	600	2.00 mm	8,143	2001820

H100

Sipariş Kodu Order Code	W (mm)	T (mm)	Ağırlık (kg/ad) Weight (kg/pcs)	Barkod Kodu Barcode Code
100 AGH 100TT	100	1.50 mm	0,952	2001821
100 AGH 160TT	160	1.50 mm	1,136	2001822
100 AGH 200TT	200	1.50 mm	1,515	2001823
100 AGH 300TT	300	1.50 mm	2,326	2001824
100 AGH 400TT	400	2.00 mm	4,825	2001825
100 AGH 500TT	500	2.00 mm	6,641	2001826
100 AGH 600TT	600	2.00 mm	8,801	2001827

H = YÜKSEKLİK = HEIGHT / W = GENİŞLİK = WIDTH / T = KALINLIK = THICKNESS

H AGH 100 TT

Yükseklik Kanal Tipi Genişlik Modül
Height Type Width Module

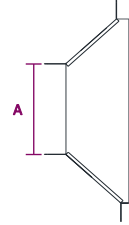

* Farklı kalınlık ve ölçülerde üretim yapılabılır.
* Malzeme ağırlıkları yaklaşık değerlerdir, \pm %10 değişiklik gösterebilir.
* Malzeme kalınlık toleransı \pm %10 dur.
* Lütfen siparişlerinizde sipariş kodu veya ürün kodu ve kaplama şeklini belirtiniz.

* We can produce cable trays different thickness and dimensions
* Cable trays are shown approximately weight, they could change \pm %10 difference.
* Cable trays thickness tolerances are shown \pm %10 .
* Please indicate order code and coating type in your orders.

AGH SERIES

REDÜKSİYON (PARÇALI)

REDUCING ANGLES (PIECE)

PREGALVANİZ (PG)
PREGALVANIZED (PG)
TS EN 10346



H40

Sipariş Kodu Order Code	W (mm)	T (mm)	Ağırlık (kg/ad) Weight (kg/pcs)	Barkod Kodu Barcode Code
40 AGH 050R	50	1.50 mm	0,175	2001400
40 AGH 100R	100	1.50 mm	0,215	2001401
40 AGH 150R	150	1.50 mm	0,250	2001402
40 AGH 200R	200	1.50 mm	0,285	2001403
40 AGH 300R	300	1.50 mm	0,360	2001404

H50

Sipariş Kodu Order Code	W (mm)	T (mm)	Ağırlık (kg/ad) Weight (kg/pcs)	Barkod Kodu Barcode Code
50 AGH 050R	50	1.50 mm	0,205	2001405
50 AGH 100R	100	1.50 mm	0,250	2001406
50 AGH 150R	150	1.50 mm	0,290	2001407
50 AGH 200R	200	1.50 mm	0,335	2001408
50 AGH 300R	300	1.50 mm	0,420	2001409

H60

Sipariş Kodu Order Code	W (mm)	T (mm)	Ağırlık (kg/ad) Weight (kg/pcs)	Barkod Kodu Barcode Code
60 AGH 050R	50	1.50 mm	0,235	2001410
60 AGH 100R	100	1.50 mm	0,285	2001411
60 AGH 150R	150	1.50 mm	0,335	2001412
60 AGH 200R	200	1.50 mm	0,380	2001413
60 AGH 300R	300	1.50 mm	0,480	2001414

H100

Sipariş Kodu Order Code	W (mm)	T (mm)	Ağırlık (kg/ad) Weight (kg/pcs)	Barkod Kodu Barcode Code
100 AGH 050R	50	1.50 mm	0,345	2001415
100 AGH 100R	100	1.50 mm	0,420	2001416
100 AGH 150R	150	1.50 mm	0,490	2001417
100 AGH 200R	200	1.50 mm	0,565	2001418
100 AGH 300R	300	1.50 mm	0,710	2001419

H = YÜKSEKLİK = HEIGHT / W = GENİŞLİK = WIDTH / T = KALINLIK = THICKNESS

H AGH 100 R

Yükseklik | Kanal Tipi | Genişlik | Modül
Height | Type | Width | Module

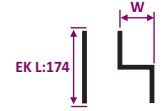

SOLA / LEFT



SAĞA / RIGHT

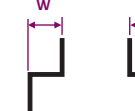

ORTADAN / FROM MIDDLE



Ürün tek olarak satılmaktadır.
The product is sold single.

ARTIM METAL ELEKTRİK A.Ş.

- * Farklı kalınlık ve ölçülerde üretim yapılabılır.
- * Malzeme ağırlıkları yaklaşık değerlerdir, \pm %10 değişiklik gösterebilir.
- * Malzeme kalınlık toleransı \pm %10 dur.
- * Lütfen siparişlerinizde sipariş kodu veya ürün kodu ve Kaplama şeklini belirtiniz.

- * We can produce cable trays different thickness and dimensions
- * Cable trays are shown approximately weight, they could change \pm %10 difference.
- * Cable trays thickness tolerances are shown \pm %10 .
- * Please indicate order code and coating type in your orders.

AGH SERIES

REDÜKSİYON (PARÇALI)

REDUCING ANGLES (PIECE)

SICAK DALDIRMA (SD)
HOT DIP GALVANIZED (SD)
TS EN ISO 1461



Sipariş Kodu Order Code	W (mm)	T (mm)	Ağırlık (kg/ad) Weight (kg/pcs)	Barkod Kodu Barcode Code
40 AGH 050R	50	1.50 mm	0,195	2001400
40 AGH 100R	100	1.50 mm	0,240	2001401
40 AGH 150R	150	1.50 mm	0,275	2001402
40 AGH 200R	200	1.50 mm	0,315	2001403
40 AGH 300R	300	1.50 mm	0,395	2001404

H40

H AGH 100 R

Yükseklik Height	Kanal Tipi Type	Genişlik Width	Modül Module
---------------------	--------------------	-------------------	-----------------

H40 + 5	65 mm		
	0 0	0 0	

H50 + 5	0 0	0 0	
---------	-----	-----	--

H60 + 5	0 0	0 0	
	0 0	0 0	

H100 + 5	0 0	0 0	
	0 0	0 0	
	0 0	0 0	
	0 0	0 0	

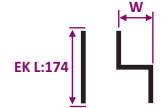

SOLA / LEFT

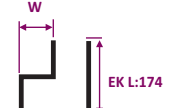

SAĞA / RIGHT

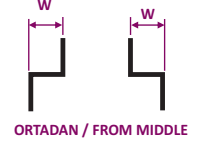

ORTADAN / FROM MIDDLE



Sipariş Kodu Order Code	W (mm)	T (mm)	Ağırlık (kg/ad) Weight (kg/pcs)	Barkod Kodu Barcode Code
50 AGH 050R	50	1.50 mm	0,225	2001405
50 AGH 100R	100	1.50 mm	0,275	2001406
50 AGH 150R	150	1.50 mm	0,320	2001407
50 AGH 200R	200	1.50 mm	0,370	2001408
50 AGH 300R	300	1.50 mm	0,435	2001409

H50

H60

Sipariş Kodu Order Code	W (mm)	T (mm)	Ağırlık (kg/ad) Weight (kg/pcs)	Barkod Kodu Barcode Code
60 AGH 050R	50	1.50 mm	0,260	2001410
60 AGH 100R	100	1.50 mm	0,315	2001411
60 AGH 150R	150	1.50 mm	0,370	2001412
60 AGH 200R	200	1.50 mm	0,420	2001413
60 AGH 300R	300	1.50 mm	0,525	2001414

H100

Sipariş Kodu Order Code	W (mm)	T (mm)	Ağırlık (kg/ad) Weight (kg/pcs)	Barkod Kodu Barcode Code
100 AGH 050R	50	1.50 mm	0,380	2001415
100 AGH 100R	100	1.50 mm	0,465	2001416
100 AGH 150R	150	1.50 mm	0,540	2001417
100 AGH 200R	200	1.50 mm	0,625	2001418
100 AGH 300R	300	1.50 mm	0,785	2001419

H = YÜKSEKLİK = HEIGHT / W = GENİŞLİK = WIDTH / T = KALINLIK = THICKNESS



Ürün tek olarak satılmaktadır.
The product is sold single.

* Farklı kalınlık ve ölçülerde üretim yapılabılır.
* Malzeme ağırlıkları yaklaşık değerlerdir, ± %10 değişiklik gösterebilir.
* Malzeme kalınlık toleransı ± %10 dur.
* Lütfen siparişlerinizde sipariş kodu veya ürün kodu ve Kaplama şeklini belirtiniz.

* We can produce cable trays different thickness and dimensions
* Cable trays are shown approximately weight, they could change ± %10 difference.
* Cable trays thickness tolerances are shown ± %10 .
* Please indicate order code and coating type in your orders.

AGH SERIES

İÇ-DİS BÜKEY DÖNÜS (HAREKETLİ)

ADJUSTABLE INSIDE-OUTSIDE VERTICAL BENDS

PREGALVANİZ (PG)
PREGALVANİZ (PG)
TS EN 10346



H40 = H50 Tek delikli
H40 = H50 One hole



H40

Sipariş Kodu Order Code	W (mm)	T (mm)	Ağırlık (kg/ad) Weight (kg/pcs)	Barkod Kodu Barcode Code
40 AGH 050B	50	1.50 mm	0,950	2001559
40 AGH 100B	100	1.50 mm	1,295	2001560
40 AGH 120B	120	1.50 mm	1,432	2001614
40 AGH 160B	160	1.50 mm	1,570	2001561
40 AGH 200B	200	1.50 mm	1,955	2001562
40 AGH 300B	300	1.50 mm	2,615	2001563
40 AGH 400B	400	2.00 mm	4,580	2001564
40 AGH 500B	500	2.00 mm	5,510	2001565
40 AGH 600B	600	2.00 mm	6,440	2001566

H50

Sipariş Kodu Order Code	W (mm)	T (mm)	Ağırlık (kg/ad) Weight (kg/pcs)	Barkod Kodu Barcode Code
50 AGH 050B	50	1.50 mm	1,070	2001575
50 AGH 100B	100	1.50 mm	1,420	2001576
50 AGH 160B	160	1.50 mm	1,895	2001577
50 AGH 200B	200	1.50 mm	2,075	2001578
50 AGH 300B	300	1.50 mm	2,735	2001579
50 AGH 400B	400	2.00 mm	4,745	2001580
50 AGH 500B	500	2.00 mm	5,670	2001581
50 AGH 600B	600	2.00 mm	6,600	2001582

H60

Sipariş Kodu Order Code	W (mm)	T (mm)	Ağırlık (kg/ad) Weight (kg/pcs)	Barkod Kodu Barcode Code
60 AGH 100B	100	1.50 mm	1,480	2001583
60 AGH 160B	160	1.50 mm	1,965	2001584
60 AGH 200B	200	1.50 mm	2,140	2001585
60 AGH 300B	300	2.00 mm	2,800	2001586
60 AGH 400B	400	2.00 mm	4,895	2001587
60 AGH 500B	500	2.00 mm	5,825	2001588
60 AGH 600B	600	2.00 mm	6,755	2001589

H100

Sipariş Kodu Order Code	W (mm)	T (mm)	Ağırlık (kg/ad) Weight (kg/pcs)	Barkod Kodu Barcode Code
100 AGH 100B	100	1.50 mm	1,825	2001590
100 AGH 160B	160	1.50 mm	2,305	2001591
100 AGH 200B	200	1.50 mm	2,485	2001592
100 AGH 300B	300	2.00 mm	3,145	2001593
100 AGH 400B	400	2.00 mm	5,350	2001594
100 AGH 500B	500	2.00 mm	6,280	2001595
100 AGH 600B	600	2.00 mm	7,210	2001596

H = YÜKSEKLİK = HEIGHT / W = GENİŞLİK = WIDTH / T = KALINLIK = THICKNESS

H AGH 100 B

Yükseklik Kanal Tipi Genişlik Modül
Height Type Width Module

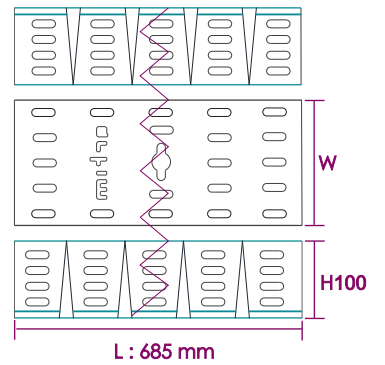
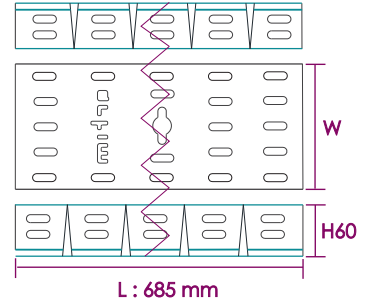
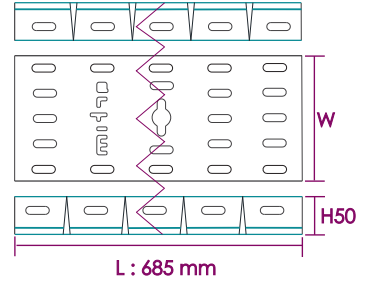
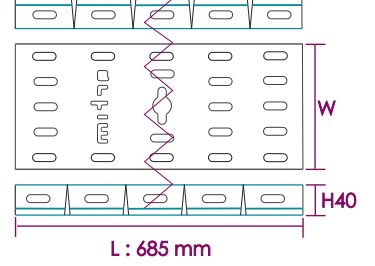

ARTIM METAL ELEKTRİK A.Ş.

- * Farklı kalınlık ve ölçülerde üretim yapılabılır.
- * Malzeme ağırlıkları yaklaşık değerlerdir, \pm %10 değişiklik gösterebilir.
- * Malzeme kalınlık toleransı \pm %10 dur.
- * Lütfen siparişlerinizde sipariş kodu veya ürün kodu ve Kaplama şeklini belirtiniz.

- We can produce cable trays different thickness and dimensions
- Cable trays are shown approximately weight, they could change \pm %10 difference.
- Cable trays thickness tolerances are shown \pm %10 .
- Please indicate order code and coating type in your orders.

AGH SERIES

İÇ-DİS BÜKEY DÖNÜS (HAREKETLİ)

ADJUSTABLE INSIDE-OUTSIDE VERTICAL BENDS

SICAK DALDIRMA (SD)

HOT DIP GALVANIZED (HDG)

TS EN ISO 1461



H40 = H50 Tek delikli
H40 = H50 One hole

H40

Sipariş Kodu Order Code	W (mm)	T (mm)	Ağırlık (kg/ad) Weight (kg/pcs)	Barkod Kodu Barcode Code
40 AGH 050B	50	1.50 mm	1,045	2001559
40 AGH 100B	100	1.50 mm	0,789	2001560
40 AGH 120B	120	1.50 mm	0,900	2001614
40 AGH 160B	160	1.50 mm	1,010	2001561
40 AGH 200B	200	1.50 mm	1,367	2001562
40 AGH 300B	300	1.50 mm	2,183	2001563
40 AGH 400B	400	2.00 mm	5,715	2001564
40 AGH 500B	500	2.00 mm	5,980	2001565
40 AGH 600B	600	2.00 mm	7,973	2001566

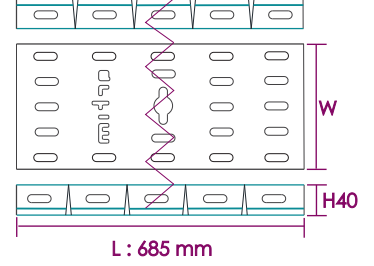
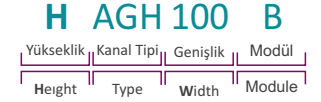

H50

Sipariş Kodu Order Code	W (mm)	T (mm)	Ağırlık (kg/ad) Weight (kg/pcs)	Barkod Kodu Barcode Code
50 AGH 050B	50	1.50 mm	1,175	2001575
50 AGH 100B	100	1.50 mm	1,555	2001576
50 AGH 160B	160	1.50 mm	2,085	2001577
50 AGH 200B	200	1.50 mm	2,280	2001578
50 AGH 300B	300	1.50 mm	3,005	2001579
50 AGH 400B	400	2.00 mm	5,215	2001580
50 AGH 500B	500	2.00 mm	6,240	2001581
50 AGH 600B	600	2.00 mm	7,260	2001582

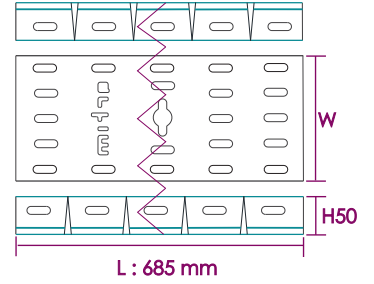

H60

Sipariş Kodu Order Code	W (mm)	T (mm)	Ağırlık (kg/ad) Weight (kg/pcs)	Barkod Kodu Barcode Code
60 AGH 100B	100	1.50 mm	1,630	2001583
60 AGH 160B	160	1.50 mm	2,160	2001584
60 AGH 200B	200	1.50 mm	2,355	2001585
60 AGH 300B	300	1.50 mm	3,080	2001586
60 AGH 400B	400	2.00 mm	5,385	2001587
60 AGH 500B	500	2.00 mm	6,410	2001588
60 AGH 600B	600	2.00 mm	7,430	2001589

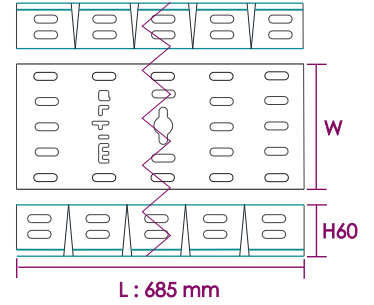

H100

Sipariş Kodu Order Code	W (mm)	T (mm)	Ağırlık (kg/ad) Weight (kg/pcs)	Barkod Kodu Barcode Code
100 AGH 100B	100	1.50 mm	2,000	2001590
100 AGH 160B	160	1.50 mm	2,540	2001591
100 AGH 200B	200	1.50 mm	2,730	2001592
100 AGH 300B	300	1.50 mm	3,460	2001593
100 AGH 400B	400	2.00 mm	5,885	2001594
100 AGH 500B	500	2.00 mm	6,905	2001595
100 AGH 600B	600	2.00 mm	7,930	2001596

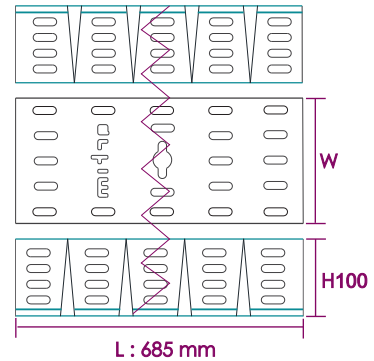

H = YÜKSEKLİK = HEIGHT / W = GENİŞLİK = WIDTH / T = KALINLIK = THICKNESS



* Farklı kalınlık ve ölçülerde üretim yapılabılır.
* Malzeme ağırlıkları yaklaşık değerlerdir, \pm %10 değişiklik gösterebilir.
* Malzeme kalınlık toleransı \pm %10 dur.
* Lütfen siparişlerinizde sipariş kodu veya ürün kodu ve kaplama şeklini belirtiniz.

* We can produce cable trays different thickness and dimensions
* Cable trays are shown approximately weight, they could change \pm %10 difference.
* Cable trays thickness tolerances are shown \pm %10 .
* Please indicate order code and coating type in your orders.

AST SERIES

İÇ-DİS BÜKEY DÖNÜS (HAREKETLİ)

ADJUSTABLE INSIDE-OUTSIDE VERTICAL BENDS

PREGALVANİZ (PG)
PREGALVANİZ (PG)
TS EN 10346



H40 = H50 Tek delikli
H40 = H50 One hole



ARTIM METAL ELEKTRİK A.Ş.

H40

Sipariş Kodu Order Code	W (mm)	T (mm)	Ağırlık (kg/ad) Weight (kg/pcs)	Barkod Kodu Barcode Code
40 AST 050B	50	1.50 mm	0,825	2001550
40 AST 100B	100	1.50 mm	1,170	2001551
40 AST 120B	120	1.50 mm	1,300	2001552
40 AST 160B	160	1.50 mm	1,495	2001553
40 AST 200B	200	1.50 mm	1,830	2001554
40 AST 300B	300	1.50 mm	2,490	2001555
40 AST 400B	400	2.00 mm	4,410	2001556
40 AST 500B	500	2.00 mm	5,335	2001557
40 AST 600B	600	2.00 mm	6,265	2001558

H50

Sipariş Kodu Order Code	W (mm)	T (mm)	Ağırlık (kg/ad) Weight (kg/pcs)	Barkod Kodu Barcode Code
50 AST 050B	50	1.50 mm	0,950	2001567
50 AST 100B	100	1.50 mm	1,295	2001568
50 AST 160B	160	1.50 mm	1,485	2001569
50 AST 200B	200	1.50 mm	1,955	2001570
50 AST 300B	300	1.50 mm	2,615	2001571
50 AST 400B	400	2.00 mm	4,580	2001572
50 AST 500B	500	2.00 mm	5,510	2001573
50 AST 600B	600	2.00 mm	6,440	2001574

H60

Sipariş Kodu Order Code	W (mm)	T (mm)	Ağırlık (kg/ad) Weight (kg/pcs)	Barkod Kodu Barcode Code
60 AST 100B	100	1.50 mm	1,480	2001597
60 AST 160B	160	1.50 mm	1,965	2001599
60 AST 200B	200	1.50 mm	2,140	2001600
60 AST 300B	300	2.00 mm	2,800	2001601
60 AST 400B	400	2.00 mm	4,895	2001602
60 AST 500B	500	2.00 mm	5,825	2001603
60 AST 600B	600	2.00 mm	6,755	2001604

H100

Sipariş Kodu Order Code	W (mm)	T (mm)	Ağırlık (kg/ad) Weight (kg/pcs)	Barkod Kodu Barcode Code
100 AST 100B	100	1.50 mm	1,825	2001605
100 AST 160B	160	1.50 mm	2,305	2001607
100 AST 200B	200	1.50 mm	2,485	2001608
100 AST 300B	300	2.00 mm	3,145	2001609
100 AST 400B	400	2.00 mm	5,350	2001610
100 AST 500B	500	2.00 mm	6,280	2001611
100 AST 600B	600	2.00 mm	7,210	2001612

H = YÜKSEKLİK = HEIGHT / W = GENİŞLİK = WIDTH / T = KALINLIK = THICKNESS

H AST 100 B

Yükseklik Kanal Tipi Genişlik Modül
Height Type Width Module

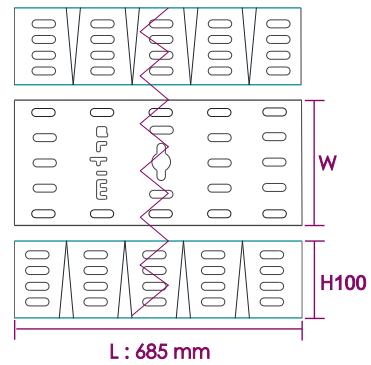
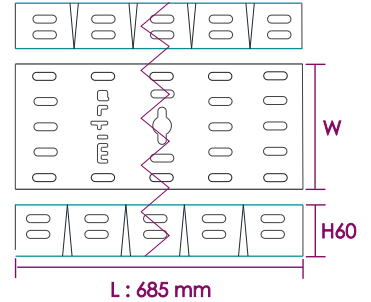
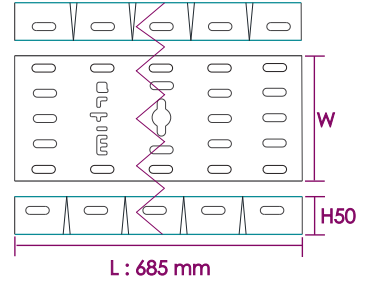
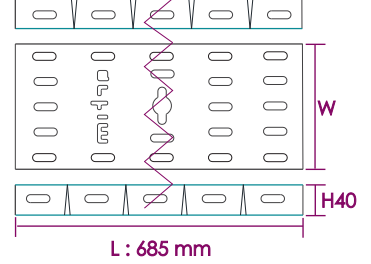

* Farklı kalınlık ve ölçülerde üretim yapılabılır.
* Malzeme ağırlıkları yaklaşık değerlerdir, ± %10 değişiklik gösterebilir.
* Malzeme kalınlık toleransı ± %10 dur.
* Lütfen siparişlerinizde sipariş kodu veya ürün kodu ve Kaplama şeklini belirtiniz.

* We can produce cable trays different thickness and dimensions
* Cable trays are shown approximately weight, they could change ± %10 difference.
* Cable trays thickness tolerances are shown ± %10 .
* Please indicate order code and coating type in your orders.

AST SERIES

İÇ-DİS BÜKEY DÖNÜS (HAREKETLİ)

ADJUSTABLE INSIDE-OUTSIDE VERTICAL BENDS

SICAK DALDIRMA (SD)

HOT DIP GALVANIZED (HDG)

TS EN ISO 1461



H40 = H50 Tek delikli

H40 = H50 One hole

H40

Sipariş Kodu Order Code	W (mm)	T (mm)	Ağırlık (kg/ad) Weight (kg/pcs)	Barkod Kodu Barcode Code
40 AST 050B	50	1.50 mm	0,905	2001550
40 AST 100B	100	1.50 mm	1,285	2001551
40 AST 120B	120	1.50 mm	1,430	2001552
40 AST 160B	160	1.50 mm	1,645	2001553
40 AST 200B	200	1.50 mm	2,010	2001554
40 AST 300B	300	1.50 mm	2,740	2001555
40 AST 400B	400	2.00 mm	4,850	2001556
40 AST 500B	500	2.00 mm	5,870	2001557
40 AST 600B	600	2.00 mm	6,895	2001558

H50

Sipariş Kodu Order Code	W (mm)	T (mm)	Ağırlık (kg/ad) Weight (kg/pcs)	Barkod Kodu Barcode Code
50 AST 050B	50	1.50 mm	1,045	2001567
50 AST 100B	100	1.50 mm	1,425	2001568
50 AST 160B	160	1.50 mm	1,635	2001569
50 AST 200B	200	1.50 mm	2,150	2001570
50 AST 300B	300	1.50 mm	2,875	2001571
50 AST 400B	400	2.00 mm	5,040	2001572
50 AST 500B	500	2.00 mm	6,060	2001573
50 AST 600B	600	2.00 mm	7,080	2001574

H60

Sipariş Kodu Order Code	W (mm)	T (mm)	Ağırlık (kg/ad) Weight (kg/pcs)	Barkod Kodu Barcode Code
60 AST 100B	100	1.50 mm	1,630	2001597
60 AST 160B	160	1.50 mm	2,160	2001599
60 AST 200B	200	1.50 mm	2,355	2001600
60 AST 300B	300	1.50 mm	3,080	2001601
60 AST 400B	400	2.00 mm	5,385	2001602
60 AST 500B	500	2.00 mm	6,410	2001603
60 AST 600B	600	2.00 mm	7,430	2001604

H100

Sipariş Kodu Order Code	W (mm)	T (mm)	Ağırlık (kg/ad) Weight (kg/pcs)	Barkod Kodu Barcode Code
100 AST 100B	100	1.50 mm	2,000	2001605
100 AST 160B	160	1.50 mm	2,540	2001607
100 AST 200B	200	1.50 mm	2,730	2001608
100 AST 300B	300	1.50 mm	3,460	2001609
100 AST 400B	400	2.00 mm	5,885	2001610
100 AST 500B	500	2.00 mm	6,905	2001611
100 AST 600B	600	2.00 mm	7,930	2001612

H = YÜKSEKLİK = HEIGHT / W = GENİŞLİK = WIDTH / T = KALINLIK = THICKNESS

H AST 100 B

Yükseklik Kanal Tipi Genişlik Modül
Height Type Width Module

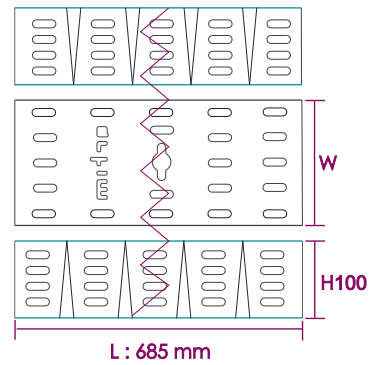
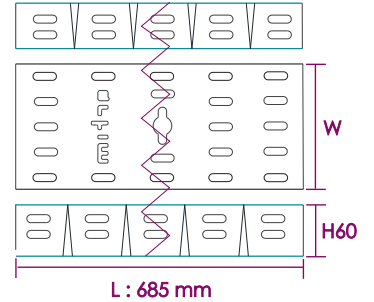
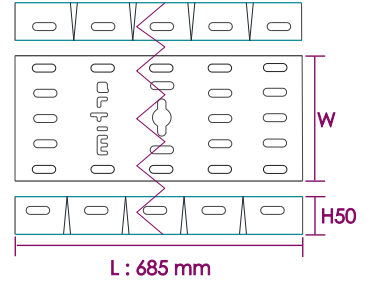
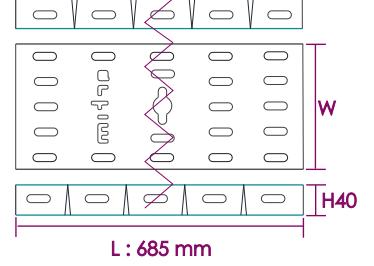

* Farklı kalınlık ve ölçülerde üretim yapılabılır.
* Malzeme ağırlıkları yaklaşık değerlerdir, ± %10 değişiklik gösterebilir.
* Malzeme kalınlık toleransı ± %10 dur.
* Lütfen siparişlerinizde sipariş kodu veya ürün kodu ve kaplama şeklini belirtiniz.

* We can produce cable trays different thickness and dimensions
* Cable trays are shown approximately weight, they could change ± %10 difference.
* Cable trays thickness tolerances are shown ± %10 .
* Please indicate order code and coating type in your orders.

AST SERIES

İÇ BÜKEY DÖNÜS (SABIT)

CONSTANT INSIDE VERTICAL BENDS

PREGALVANİZ (PG)
PREGALVANİZ (PG)
TS EN 10346



H40 = H50 Tek delikli
H40 = H50 One hole



ARTIM METAL ELEKTRİK A.Ş.

H40

Sipariş Kodu Order Code	W (mm)	T (mm)	Ağırlık (kg/ad) Weight (kg/pcs)	Barkod Kodu Barcode Code
40 AST 050B S1	50	1.50 mm	1,135	2001500
40 AST 100B S1	100	1.50 mm	1,475	2001501
40 AST 120B S1	120	1.50 mm	1,615	2001502
40 AST 160B S1	160	1.50 mm	1,880	2001503
40 AST 200B S1	200	1.50 mm	2,165	2001504
40 AST 300B S1	300	1.50 mm	2,860	2001505
40 AST 400B S1	400	2.00 mm	4,720	2001506
40 AST 500B S1	500	2.00 mm	5,650	2001507
40 AST 600B S1	600	2.00 mm	6,570	2001508

H50

Sipariş Kodu Order Code	W (mm)	T (mm)	Ağırlık (kg/ad) Weight (kg/pcs)	Barkod Kodu Barcode Code
50 AST 050B S1	50	1.50 mm	1,235	2001509
50 AST 100B S1	100	1.50 mm	1,575	2001510
50 AST 160B S1	160	1.50 mm	1,975	2001512
50 AST 200B S1	200	1.50 mm	2,265	2001513
50 AST 300B S1	300	1.50 mm	2,960	2001514
50 AST 400B S1	400	2.00 mm	4,875	2001515
50 AST 500B S1	500	2.00 mm	5,650	2001516
50 AST 600B S1	600	2.00 mm	6,715	2001517

H60

Sipariş Kodu Order Code	W (mm)	T (mm)	Ağırlık (kg/ad) Weight (kg/pcs)	Barkod Kodu Barcode Code
60 AST 100B S1	100	1.50 mm	1,685	2001518
60 AST 160B S1	160	1.50 mm	2,085	2001520
60 AST 200B S1	200	1.50 mm	2,370	2001521
60 AST 300B S1	300	2.00 mm	3,065	2001522
60 AST 400B S1	400	2.00 mm	5,015	2001523
60 AST 500B S1	500	2.00 mm	5,935	2001524
60 AST 600B S1	600	2.00 mm	6,855	2001525

H100

Sipariş Kodu Order Code	W (mm)	T (mm)	Ağırlık (kg/ad) Weight (kg/pcs)	Barkod Kodu Barcode Code
100 AST 100B S1	100	1.50 mm	2,050	2001526
100 AST 160B S1	160	1.50 mm	2,455	2001528
100 AST 200B S1	200	1.50 mm	2,745	2001529
100 AST 300B S1	300	2.00 mm	3,435	2001530
100 AST 400B S1	400	2.00 mm	5,500	2001531
100 AST 500B S1	500	2.00 mm	6,420	2001532
100 AST 600B S1	600	2.00 mm	7,340	2001533

H = YÜKSEKLİK = HEIGHT / W = GENİŞLİK = WIDTH / T = KALINLIK = THICKNESS

H AST 100 B S1

Yükseklik Kanal Tipi Genişlik Modül
Height Type Width Module

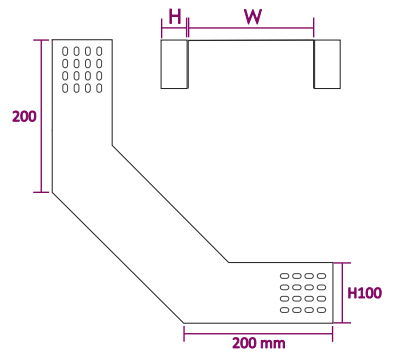
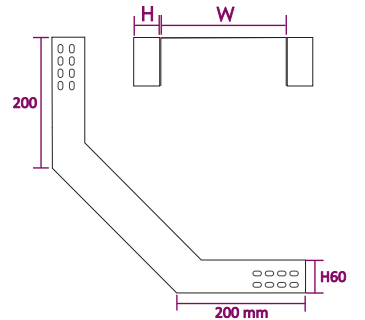
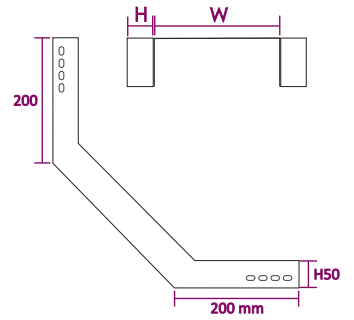
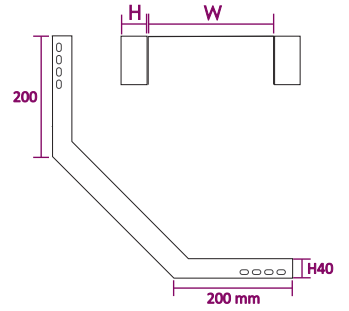

* Farklı kalınlık ve ölçülerde üretim yapılabılır.
* Malzeme ağırlıkları yaklaşık değerlerdir, ± %10 değişiklik gösterebilir.
* Malzeme kalınlık toleransı ± %10 dur.
* Lütfen siparişlerinizde sipariş kodu veya ürün kodu ve Kaplama şeklini belirtiniz.

* We can produce cable trays different thickness and dimensions
* Cable trays are shown approximately weight, they could change ± %10 difference.
* Cable trays thickness tolerances are shown ± %10 .
* Please indicate order code and coating type in your orders.

AST SERIES

İÇ BÜKEY DÖNÜŞ (SABİT)

CONSTANT INSIDE VERTICAL BENDS

SICAK DALDIRMA (SD)

HOT DIP GALVANIZED (HDG)

TS EN ISO 1461



H40 = H50 Tek delikli
H40 = H50 One hole

H40

Sipariş Kodu Order Code	W (mm)	T (mm)	Ağırlık (kg/ad) Weight (kg/pcs)	Barkod Kodu Barcode Code
40 AST 050B S1	50	1.50 mm	1,245	2001500
40 AST 100B S1	100	1.50 mm	1,625	2001501
40 AST 120B S1	120	1.50 mm	1,775	2001502
40 AST 160B S1	160	1.50 mm	2,070	2001503
40 AST 200B S1	200	1.50 mm	3,145	2001504
40 AST 300B S1	300	1.50 mm	3,575	2001505
40 AST 400B S1	400	2.00 mm	5,195	2001506
40 AST 500B S1	500	2.00 mm	6,215	2001507
40 AST 600B S1	600	2.00 mm	7,230	2001508

H50

Sipariş Kodu Order Code	W (mm)	T (mm)	Ağırlık (kg/ad) Weight (kg/pcs)	Barkod Kodu Barcode Code
50 AST 050B S1	50	1.50 mm	1,355	2001509
50 AST 100B S1	100	1.50 mm	1,735	2001510
50 AST 160B S1	160	1.50 mm	2,175	2001512
50 AST 200B S1	200	1.50 mm	2,490	2001513
50 AST 300B S1	300	1.50 mm	3,255	2001514
50 AST 400B S1	400	2.00 mm	5,365	2001515
50 AST 500B S1	500	2.00 mm	6,215	2001516
50 AST 600B S1	600	2.00 mm	7,385	2001517

H60

Sipariş Kodu Order Code	W (mm)	T (mm)	Ağırlık (kg/ad) Weight (kg/pcs)	Barkod Kodu Barcode Code
60 AST 100B S1	100	1.50 mm	1,850	2001518
60 AST 160B S1	160	1.50 mm	2,295	2001520
60 AST 200B S1	200	1.50 mm	2,610	2001521
60 AST 300B S1	300	1.50 mm	3,370	2001522
60 AST 400B S1	400	2.00 mm	5,515	2001523
60 AST 500B S1	500	2.00 mm	6,530	2001524
60 AST 600B S1	600	2.00 mm	7,540	2001525

H100

Sipariş Kodu Order Code	W (mm)	T (mm)	Ağırlık (kg/ad) Weight (kg/pcs)	Barkod Kodu Barcode Code
100 AST 100B S1	100	1.50 mm	2,255	2001526
100 AST 160B S1	160	1.50 mm	2,700	2001528
100 AST 200B S1	200	1.50 mm	3,020	2001529
100 AST 300B S1	300	1.50 mm	3,775	2001530
100 AST 400B S1	400	2.00 mm	6,050	2001531
100 AST 500B S1	500	2.00 mm	7,065	2001532
100 AST 600B S1	600	2.00 mm	8,075	2001533

H = YÜKSEKLİK = HEIGHT / W = GENİŞLİK = WIDTH / T = KALINLIK = THICKNESS

H AST 100 B S1

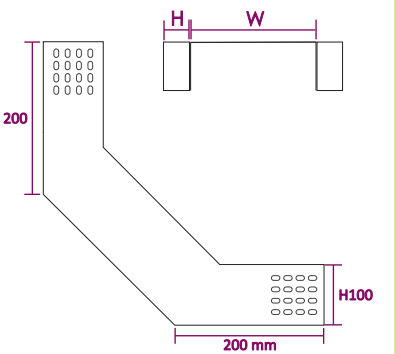
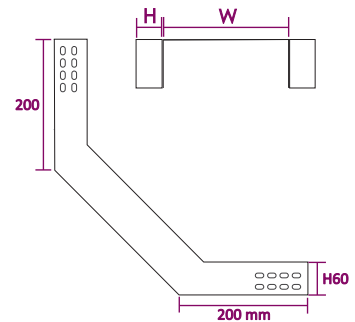
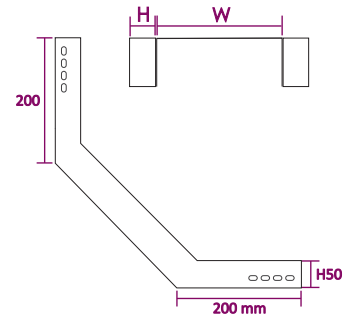
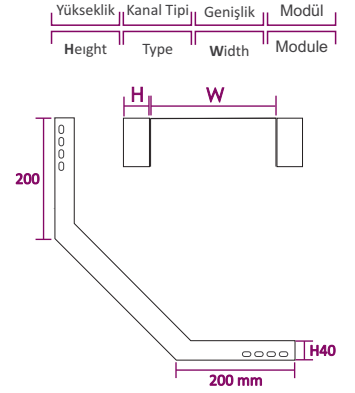

* Farklı kalınlık ve ölçülerde üretim yapılabılır.
* Malzeme ağırlıkları yaklaşık değerlerdir, ± %10 değişiklik gösterebilir.
* Malzeme kalınlık toleransı ± %10 dur.
* Lütfen siparişlerinizde sipariş kodu veya ürün kodu ve kaplama şeklini belirtiniz.

* We can produce cable trays different thickness and dimensions
* Cable trays are shown approximately weight, they could change ± %10 difference.
* Cable trays thickness tolerances are shown ± %10 .
* Please indicate order code and coating type in your orders.

AST SERIES

DIS BÜKEY DÖNÜS (SABIT)

CONSTANT OUTSIDE VERTICAL BENDS

PREGALVANIZ (PG)
PREGALVANIZED (PG)
TS EN 10346



H40 = H50 Tek delikli
H40 = H50 One hole



H40

Sipariş Kodu Order Code	W (mm)	T (mm)	Ağırlık (kg/ad) Weight (kg/pcs)	Barkod Kodu Barcode Code
40 AST 050B S2	50	1.50 mm	1,135	2001500
40 AST 100B S2	100	1.50 mm	1,475	2001501
40 AST 120B S2	120	1.50 mm	1,615	2001502
40 AST 160B S2	160	1.50 mm	1,880	2001503
40 AST 200B S2	200	1.50 mm	2,165	2001504
40 AST 300B S2	300	1.50 mm	2,860	2001505
40 AST 400B S2	400	2.00 mm	4,720	2001506
40 AST 500B S2	500	2.00 mm	5,650	2001507
40 AST 600B S2	600	2.00 mm	6,570	2001508

H50

Sipariş Kodu Order Code	W (mm)	T (mm)	Ağırlık (kg/ad) Weight (kg/pcs)	Barkod Kodu Barcode Code
50 AST 050B S2	50	1.50 mm	1,235	2001509
50 AST 100B S2	100	1.50 mm	1,575	2001510
50 AST 160B S2	160	1.50 mm	1,975	2001512
50 AST 200B S2	200	1.50 mm	2,265	2001513
50 AST 300B S2	300	1.50 mm	2,960	2001514
50 AST 400B S2	400	2.00 mm	4,875	2001515
50 AST 500B S2	500	2.00 mm	5,650	2001516
50 AST 600B S2	600	2.00 mm	6,715	2001517

H60

Sipariş Kodu Order Code	W (mm)	T (mm)	Ağırlık (kg/ad) Weight (kg/pcs)	Barkod Kodu Barcode Code
60 AST 100B S2	100	1.50 mm	1,685	2001518
60 AST 160B S2	160	1.50 mm	2,085	2001520
60 AST 200B S2	200	1.50 mm	2,370	2001521
60 AST 300B S2	300	2.00 mm	3,065	2001522
60 AST 400B S2	400	2.00 mm	5,015	2001523
60 AST 500B S2	500	2.00 mm	5,935	2001524
60 AST 600B S2	600	2.00 mm	6,855	2001525

H100

Sipariş Kodu Order Code	W (mm)	T (mm)	Ağırlık (kg/ad) Weight (kg/pcs)	Barkod Kodu Barcode Code
100 AST 100B S2	100	1.50 mm	2,050	2001526
100 AST 160B S2	160	1.50 mm	2,455	2001528
100 AST 200B S2	200	1.50 mm	2,745	2001529
100 AST 300B S2	300	2.00 mm	3,435	2001530
100 AST 400B S2	400	2.00 mm	5,500	2001531
100 AST 500B S2	500	2.00 mm	6,420	2001532
100 AST 600B S2	600	2.00 mm	7,340	2001533

H = YÜKSEKLİK = HEIGHT / W = GENİŞLİK = WIDTH / T = KALINLIK = THICKNESS

H AST 100 B S2

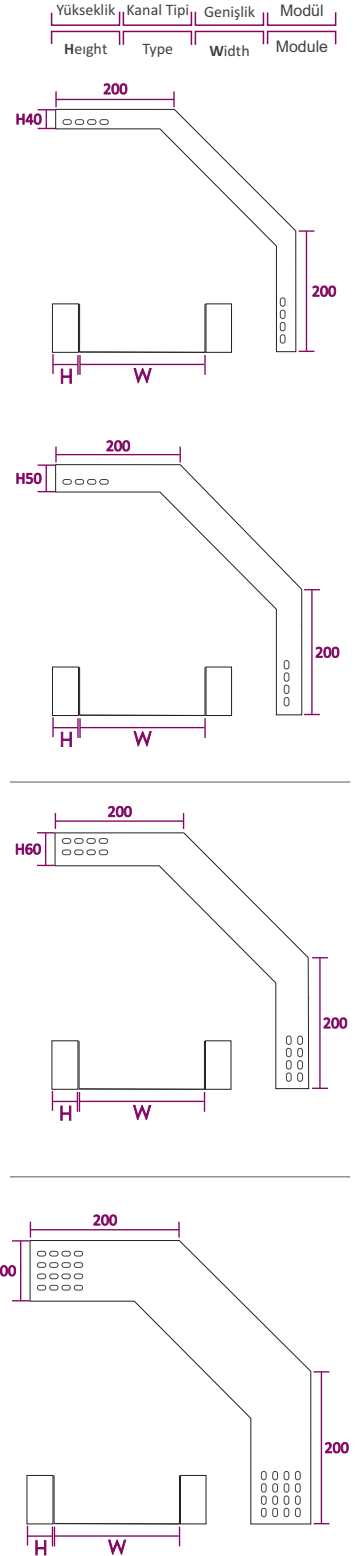

ARTIM METAL ELEKTRİK A.Ş.

* Farklı kalınlık ve ölçülerde üretim yapılabılır.
* Malzeme ağırlıkları yaklaşık değerlerdir, \pm %10 değişiklik gösterebilir.
* Malzeme kalınlık toleransı \pm %10 dur.
* Lütfen siparişlerinizde sipariş kodu veya ürün kodu ve Kaplama şeklini belirtiniz.

* We can produce cable trays different thickness and dimensions
* Cable trays are shown approximately weight, they could change \pm %10 difference.
* Cable trays thickness tolerances are shown \pm %10 .
* Please indicate order code and coating type in your orders.

AST SERIES

DIS BÜKEY DÖNÜS (SABIT)

CONSTANT OUTSIDE VERTICAL BENDS

SICAK DALDIRMA (SD)

HOT DIP GALVANIZED (HDG)

TS EN ISO 1461



H40 = H50 Tek delikli
H40 = H50 One hole

Sipariş Kodu Order Code	W (mm)	T (mm)	Ağırlık (kg/ad) Weight (kg/pcs)	Barkod Kodu Barcode Code
40 AST 050B S2	50	1.50 mm	1,245	2001500
40 AST 100B S2	100	1.50 mm	1,625	2001501
40 AST 120B S2	120	1.50 mm	1,775	2001502
40 AST 160B S2	160	1.50 mm	2,070	2001503
40 AST 200B S2	200	1.50 mm	3,145	2001504
40 AST 300B S2	300	1.50 mm	3,575	2001505
40 AST 400B S2	400	2.00 mm	5,195	2001506
40 AST 500B S2	500	2.00 mm	6,215	2001507
40 AST 600B S2	600	2.00 mm	7,230	2001508

Sipariş Kodu Order Code	W (mm)	T (mm)	Ağırlık (kg/ad) Weight (kg/pcs)	Barkod Kodu Barcode Code
50 AST 050B S2	50	1.50 mm	1,355	2001509
50 AST 100B S2	100	1.50 mm	1,735	2001510
50 AST 160B S2	160	1.50 mm	2,175	2001512
50 AST 200B S2	200	1.50 mm	2,490	2001513
50 AST 300B S2	300	1.50 mm	3,255	2001514
50 AST 400B S2	400	2.00 mm	5,365	2001515
50 AST 500B S2	500	2.00 mm	6,215	2001516
50 AST 600B S2	600	2.00 mm	7,385	2001517

Sipariş Kodu Order Code	W (mm)	T (mm)	Ağırlık (kg/ad) Weight (kg/pcs)	Barkod Kodu Barcode Code
60 AST 100B S2	100	1.50 mm	1,850	2001518
60 AST 160B S2	160	1.50 mm	2,295	2001520
60 AST 200B S2	200	1.50 mm	2,610	2001521
60 AST 300B S2	300	1.50 mm	3,370	2001522
60 AST 400B S2	400	2.00 mm	5,515	2001523
60 AST 500B S2	500	2.00 mm	6,530	2001524
60 AST 600B S2	600	2.00 mm	7,540	2001525

Sipariş Kodu Order Code	W (mm)	T (mm)	Ağırlık (kg/ad) Weight (kg/pcs)	Barkod Kodu Barcode Code
100 AST 100B S2	100	1.50 mm	2,255	2001526
100 AST 160B S2	160	1.50 mm	2,700	2001528
100 AST 200B S2	200	1.50 mm	3,020	2001529
100 AST 300B S2	300	1.50 mm	3,775	2001530
100 AST 400B S2	400	2.00 mm	6,050	2001531
100 AST 500B S2	500	2.00 mm	7,065	2001532
100 AST 600B S2	600	2.00 mm	8,075	2001533

H = YÜKSEKLİK = HEIGHT / W = GENİŞLİK = WIDTH / T = KALINLIK = THICKNESS

H AST 100 B S2

Yükseklik Kanal Tipi Genişlik Modül
Height Type Width Module

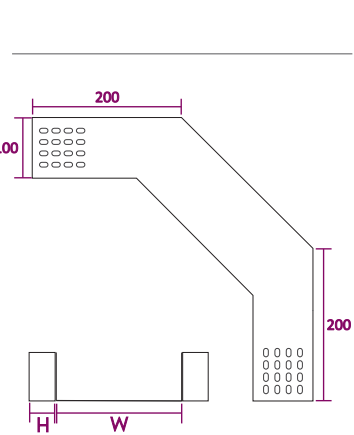
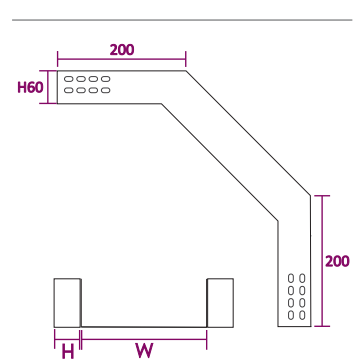
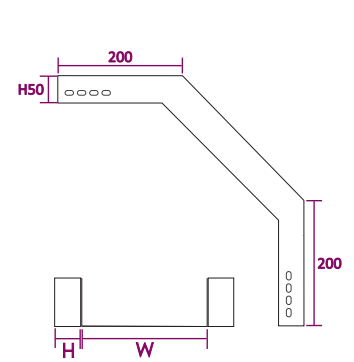
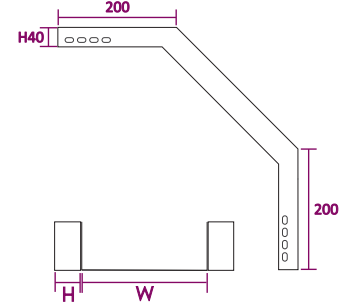

* Farklı kalınlık ve ölçülerde üretim yapılabılır.
* Malzeme ağırlıkları yaklaşık değerlerdir, ± %10 değişiklik gösterebilir.
* Malzeme kalınlık toleransı ± %10 dur.
* Lütfen siparişlerinizde sipariş kodu veya ürün kodu ve kaplama şeklini belirtiniz.

* We can produce cable trays different thickness and dimensions
* Cable trays are shown approximately weight, they could change ± %10 difference.
* Cable trays thickness tolerances are shown ± %10 .
* Please indicate order code and coating type in your orders.

AGH SERIES

DIKEY & YATAY SEVIYE DEGİSTİRME

VERTICAL & HORIZONTAL ANGLE CONNECTOR

PREGALVANİZ (PG)
PREGALVANİZED (PG)
TS EN 10346



H40 = H50 Tek delikli
H40 = H50 One hole

H60 = Çift delikli
H60 = Double hole

H100 = Dört delikli
H100 = Four holes

Ürün tek parça satılmaktadır. 1 Takım için;
4 adet Seviye Degistirici, 4 adet M8x15 Civata,
4 adet Somun kullanılmaktadır.
The product is sold in one piece. For 1 Team;
4 Angle Connector, 4 M8x15 Bolts,
4 Nuts are used.

DİKEY & VERTICAL				
Sipariş Kodu Order Code	L (mm)	T (mm)	Ağırlık (kg/ad) Weight (kg/pcs)	Barkod Kodu Barcode Code
40 AGH 00 S	160	1.50 mm	0,096	2001600
50 AGH 00 S	160	1.50 mm	0,115	2001602
60 AGH 00 S	160	1.50 mm	0,135	2001604
100 AGH 00 S	160	1.50 mm	0,205	2001606



H AGH 00 S			
Yükseklik Height	Kanal Tipi Type	Genişlik Width	Modül Module

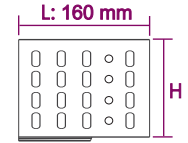
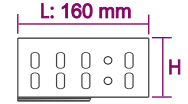

H40 = H50 Tek delikli
H40 = H50 One hole

H60 = Çift delikli
H60 = Double hole

H100 = Dört delikli
H100 = Four holes

Ürün tek parça satılmaktadır. 1 Takım için;
2 adet Seviye Degistirici, 4 adet M8x15 Civata,
4 adet Somun kullanılmaktadır.
The product is sold in one piece. For 1 Team;
4 Angle Connector, 4 M8x15 Bolts,
4 Nuts are used.

YATAY & HORIZONTAL				
Sipariş Kodu Order Code	L (mm)	T (mm)	Ağırlık (kg/ad) Weight (kg/pcs)	Barkod Kodu Barcode Code
40 AGH 01 S	230	1.50 mm	0,096	2001601
50 AGH 01 S	230	1.50 mm	0,161	2001603
60 AGH 01 S	230	1.50 mm	0,232	2001605
100 AGH 01 S	230	1.50 mm	0,267	2001607

L = BOY = LENGTH / T = KALINLIK = THICKNESS



H AGH 01 S			
Yükseklik Height	Kanal Tipi Type	Genişlik Width	Modül Module

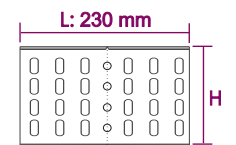
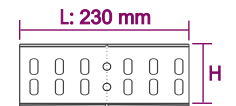

ARTIM METAL ELEKTRİK A.Ş.

- * Farklı kalınlık ve ölçülerde üretim yapılabılır.
- * Malzeme ağırlıkları yaklaşık değerlerdir, \pm %10 değişiklik gösterebilir.
- * Malzeme kalınlık toleransı \pm %10 dur.
- * Lütfen siparişlerinizde sipariş kodu veya ürün kodu ve Kaplama şeklini belirtiniz.

- * We can produce cable trays different thickness and dimensions
- * Cable trays are shown approximately weight, they could change \pm %10 difference.
- * Cable trays thickness tolerances are shown \pm %10 .
- * Please indicate order code and coating type in your orders.

AGH SERIES

DIKEY & YATAY SEVIYE DEGİSTİRME

VERTICAL & HORIZONTAL ANGLE CONNECTOR

SICAK DALDIRMA (SD)

HOT DIP GALVANIZED (HDG)

TS EN ISO 1461



H40 = H50 Tek delikli
H40 = H50 One hole

H60 = Çift delikli
H60 = Double hole

H100 = Dört delikli
H100 = Four holes

Ürün tek parça satılmaktadır. 1 Takım için;
4 adet Seviye Degistirici, 6 adet M8x15 Cıvata,
6 adet Somun kullanılmaktadır.

The product is sold in one piece. For 1 Team;
4 Angle Connector, 6 M8x15 Bolts,
6 Nuts are used.

Sipariş Kodu Order Code	L (mm)	T (mm)	Ağırlık (kg/ad) Weight (kg/pcs)	Barkod Kodu Barcode Code
40 AGH 00 S	160	1.50 mm	0,105	2001600
50 AGH 00 S	160	1.50 mm	0,130	2001602
60 AGH 00 S	160	1.50 mm	0,150	2001604
100 AGH 00 S	160	1.50 mm	0,225	2001606

DİKEY & VERTICAL



H AGH 00 S

Yükseklik Height	Kanal Tipi Type	Genişlik Width	Modül Module
---------------------	--------------------	-------------------	-----------------

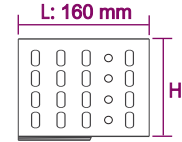
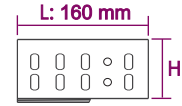
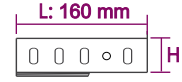

H40 = H50 Tek delikli
H40 = H50 One hole

H60 = Çift delikli
H60 = Double hole

H100 = Dört delikli
H100 = Four holes

Ürün tek parça satılmaktadır. 1 Takım için;
2 adet Seviye Degistirici, 4 adet M8x15 Cıvata,
4 adet Somun kullanılmaktadır.

The product is sold in one piece. For 1 Team;
4 Angle Connector, 4 M8x15 Bolts,
4 Nuts are used.

Sipariş Kodu Order Code	W (mm)	T (mm)	Ağırlık (kg/ad) Weight (kg/pcs)	Barkod Kodu Barcode Code
40 AGH 01 S	230	1.50 mm	0,096	2001601
50 AGH 01 S	230	1.50 mm	0,179	2001603
60 AGH 01 S	230	1.50 mm	0,256	2001605
100 AGH 01 S	230	1.50 mm	0,296	2001607

YATAY & HORIZONTAL

L = BOY = LENGTH / T = KALINLIK = THICKNESS



H AGH 01 S

Yükseklik Height	Kanal Tipi Type	Genişlik Width	Modül Module
---------------------	--------------------	-------------------	-----------------

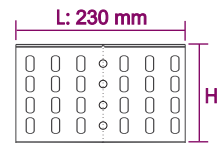
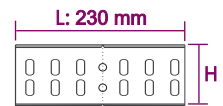

* Farklı kalınlık ve ölçülerde üretim yapılabılır.
* Malzeme ağırlıkları yaklaşık değerlerdir, ± %10 değişiklik gösterebilir.
* Malzeme kalınlık toleransı ± %10 dur.
* Lütfen siparişlerinizde sipariş kodu veya ürün kodu ve Kaplama şeklini belirtiniz.

* We can produce cable trays different thickness and dimensions
* Cable trays are shown approximately weight, they could change ± %10 difference.
* Cable trays thickness tolerances are shown ± %10 .
* Please indicate order code and coating type in your orders.

AGH SERIES

DIKEY T BAGLANTI

VERTICAL TEES

PREGALVANIZ (PG)
PREGALVANIZED (PG)
TS EN 10346



H40 = H50 Tek delikli
H40 = H50 One hole



H40

Sipariş Kodu Order Code	W (mm)	T (mm)	Ağırlık (kg/ad) Weight (kg/pcs)	Barkod Kodu Barcode Code
40 AGH 050 DD	50	1.50 mm	1,150	2001700
40 AGH 100 DD	100	1.50 mm	1,675	2001701
40 AGH 120 DD	120	1.50 mm	1,900	2001702
40 AGH 160 DD	160	1.50 mm	2,350	2001703
40 AGH 200 DD	200	1.50 mm	2,870	2001704
40 AGH 300 DD	300	1.50 mm	4,285	2001705
40 AGH 400 DD	400	2.00 mm	7,910	2001706
40 AGH 500 DD	500	2.00 mm	10,480	2001707
40 AGH 600 DD	600	2.00 mm	13,255	2001708

H50

Sipariş Kodu Order Code	W (mm)	T (mm)	Ağırlık (kg/ad) Weight (kg/pcs)	Barkod Kodu Barcode Code
50 AGH 050 DD	50	1.50 mm	1,290	2001718
50 AGH 100 DD	100	1.50 mm	1,825	2001719
50 AGH 120 DD	120	1.50 mm	2,342	2001762
50 AGH 160 DD	160	1.50 mm	2,860	2001720
50 AGH 200 DD	200	1.50 mm	3,045	2001721
50 AGH 300 DD	300	1.50 mm	4,485	2001722
50 AGH 400 DD	400	2.00 mm	8,210	2001723
50 AGH 500 DD	500	2.00 mm	10,810	2001724
50 AGH 600 DD	600	2.00 mm	13,620	2001725

H60

Sipariş Kodu Order Code	W (mm)	T (mm)	Ağırlık (kg/ad) Weight (kg/pcs)	Barkod Kodu Barcode Code
60 AGH 100 DD	100	1.50 mm	1,985	2001734
60 AGH 120 DD	120	1.50 mm	2,187	2001763
60 AGH 160 DD	160	1.50 mm	2,390	2001735
60 AGH 200 DD	200	1.50 mm	3,220	2001736
60 AGH 300 DD	300	2.00 mm	4,685	2001737
60 AGH 400 DD	400	2.00 mm	8,500	2001738
60 AGH 500 DD	500	2.00 mm	11,140	2001739
60 AGH 600 DD	600	2.00 mm	13,980	2001740

H100

Sipariş Kodu Order Code	W (mm)	T (mm)	Ağırlık (kg/ad) Weight (kg/pcs)	Barkod Kodu Barcode Code
100 AGH 100 DD	100	1.50 mm	2,570	2001748
100 AGH 120 DD	120	1.50 mm	2,922	2001764
100 AGH 160 DD	160	1.50 mm	3,275	2001749
100 AGH 200 DD	200	1.50 mm	3,910	2001750
100 AGH 300 DD	300	2.00 mm	5,455	2001751
100 AGH 400 DD	400	2.00 mm	9,670	2001752
100 AGH 500 DD	500	2.00 mm	12,430	2001753
100 AGH 600 DD	600	2.00 mm	14,670	2001754

H = YÜKSEKLİK = HEIGHT / W = GENİŞLİK = WIDTH / T = KALINLIK = THICKNESS

H AGH 100 DD

Yükseklik Kanal Tipi Genişlik Modül
Height Type Width Module

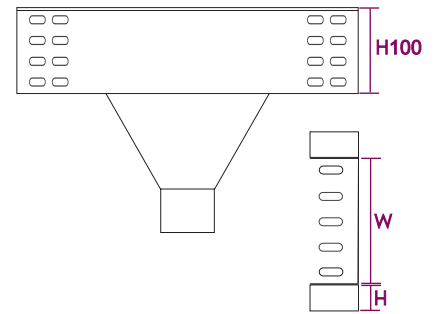
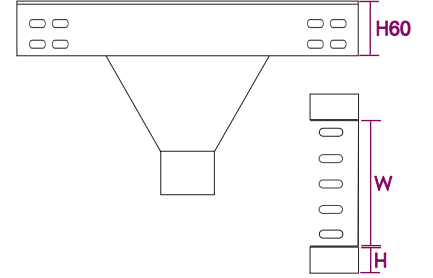
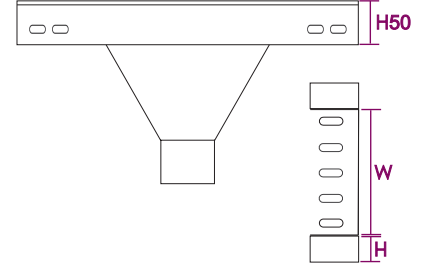
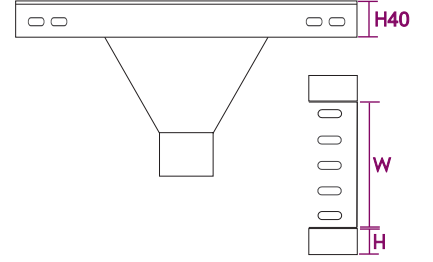

ARTIM METAL ELEKTRİK A.Ş.

- * Farklı kalınlık ve ölçülerde üretim yapılabılır.
- * Malzeme ağırlıkları yaklaşık değerlerdir, ± %10 değişiklik gösterebilir.
- * Malzeme kalınlık toleransı ± %10 dur.
- * Lütfen siparişlerinizde sipariş kodu veya ürün kodu ve Kaplama şeklini belirtiniz.

- * We can produce cable trays different thickness and dimensions
- * Cable trays are shown approximately weight, they could change ± %10 difference.
- * Cable trays thickness tolerances are shown ± %10 .
- * Please indicate order code and coating type in your orders.

AGH SERIES

DIKEY T BAGLANTI

VERTICAL TEES

SICAK DALDIRMA (SD)

HOT DIP GALVANIZED (SD)

TS EN ISO 1461



H40 = H50 Tek delikli
H40 = H50 One hole

H40

Sipariş Kodu Order Code	W (mm)	T (mm)	Ağırlık (kg/ad) Weight (kg/pcs)	Barkod Kodu Barcode Code
40 AGH 050 DD	50	1.50 mm	1,270	2001700
40 AGH 100 DD	100	1.50 mm	1,845	2001701
40 AGH 120 DD	120	1.50 mm	2,095	2001702
40 AGH 160 DD	160	1.50 mm	2,455	2001703
40 AGH 200 DD	200	1.50 mm	3,240	2001704
40 AGH 300 DD	300	1.50 mm	4,715	2001705
40 AGH 400 DD	400	2.00 mm	8,700	2001706
40 AGH 500 DD	500	2.00 mm	11,535	2001707
40 AGH 600 DD	600	2.00 mm	14,510	2001708

H50

Sipariş Kodu Order Code	W (mm)	T (mm)	Ağırlık (kg/ad) Weight (kg/pcs)	Barkod Kodu Barcode Code
50 AGH 050 DD	50	1.50 mm	1,420	2001718
50 AGH 100 DD	100	1.50 mm	2,010	2001719
50 AGH 120 DD	120	1.50 mm	2,580	2001762
50 AGH 160 DD	160	1.50 mm	3,150	2001720
50 AGH 200 DD	200	1.50 mm	3,350	2001721
50 AGH 300 DD	300	1.50 mm	4,930	2001722
50 AGH 400 DD	400	2.00 mm	9,030	2001723
50 AGH 500 DD	500	2.00 mm	11,890	2001724
50 AGH 600 DD	600	2.00 mm	14,985	2001725

H60

Sipariş Kodu Order Code	W (mm)	T (mm)	Ağırlık (kg/ad) Weight (kg/pcs)	Barkod Kodu Barcode Code
60 AGH 100 DD	100	1.50 mm	2,180	2001734
60 AGH 120 DD	120	1.50 mm	2,405	2001763
60 AGH 160 DD	160	1.50 mm	2,630	2001735
60 AGH 200 DD	200	1.50 mm	3,545	2001736
60 AGH 300 DD	300	1.50 mm	5,150	2001737
60 AGH 400 DD	400	2.00 mm	9,350	2001738
60 AGH 500 DD	500	2.00 mm	12,255	2001739
60 AGH 600 DD	600	2.00 mm	15,380	2001740

H100

Sipariş Kodu Order Code	W (mm)	T (mm)	Ağırlık (kg/ad) Weight (kg/pcs)	Barkod Kodu Barcode Code
100 AGH 100 DD	100	1.50 mm	2,830	2001748
100 AGH 120 DD	120	1.50 mm	3,215	2001764
100 AGH 160 DD	160	1.50 mm	3,600	2001749
100 AGH 200 DD	200	1.50 mm	4,295	2001750
100 AGH 300 DD	300	1.50 mm	6,000	2001751
100 AGH 400 DD	400	2.00 mm	10,635	2001752
100 AGH 500 DD	500	2.00 mm	13,670	2001753
100 AGH 600 DD	600	2.00 mm	16,135	2001754

H = YÜKSEKLİK = HEIGHT / W = GENİŞLİK = WIDTH / T = KALINLIK = THICKNESS

H AGH 100 DD

Yükseklik Kanal Tipi Genişlik Modül
Height Type Width Module

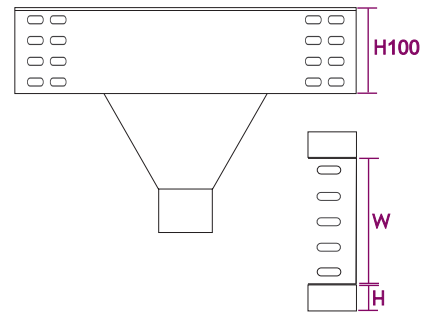
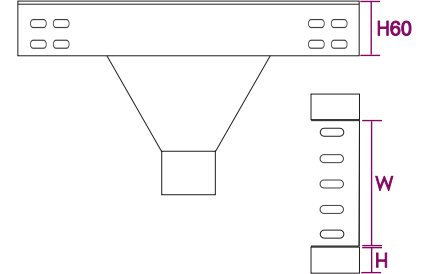
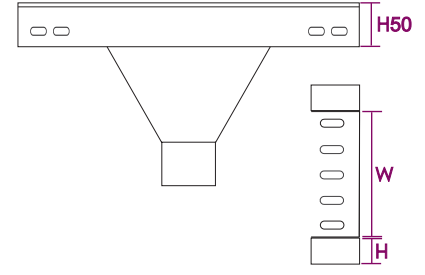
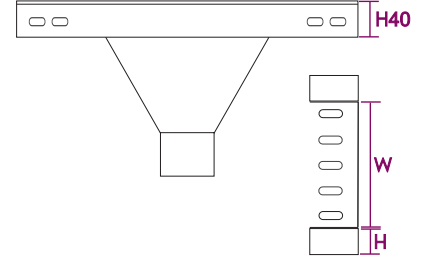

* Farklı kalınlık ve ölçülerde üretim yapılabılır.
* Malzeme ağırlıkları yaklaşık değerlerdir, ± %10 değişiklik gösterebilir.
* Malzeme kalınlık toleransı ± %10 dur.
* Lütfen siparişlerinizde sipariş kodu veya ürün kodu ve Kaplama şeklini belirtiniz.

* We can produce cable trays different thickness and dimensions
* Cable trays are shown approximately weight, they could change ± %10 difference.
* Cable trays thickness tolerances are shown ± %10 .
* Please indicate order code and coating type in your orders.

AGH SERIES

ORTADAN T BAĞLANTI

FRO MIDDLE VERTICAL TEES

PREGALVANİZ (PG)
PREGALVANİZED (PG)
TS EN 10346



H40 = H50 Tek delikli
H40 = H50 One hole

H40

Sipariş Kodu Order Code	W (mm)	T (mm)	Ağırlık (kg/ad) Weight (kg/pcs)	Barkod Kodu Barcode Code
40 AGH 050 DO	50	1.50 mm	1,615	2001709
40 AGH 100 DO	100	1.50 mm	2,040	2001710
40 AGH 120 DO	120	1.50 mm	2,210	2001711
40 AGH 160 DO	160	1.50 mm	2,545	2001712
40 AGH 200 DO	200	1.50 mm	2,885	2001713
40 AGH 300 DO	300	1.50 mm	3,735	2001714
40 AGH 400 DO	400	2.00 mm	6,100	2001715
40 AGH 500 DO	500	2.00 mm	7,230	2001716
40 AGH 600 DO	600	2.00 mm	8,355	2001717

H AGH 100 DO

Yükseklik Kanal Tipi Genişlik Modül
Height Type Width Module

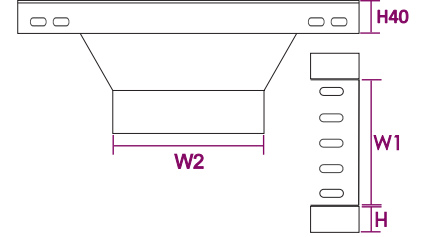

H50

Sipariş Kodu Order Code	W (mm)	T (mm)	Ağırlık (kg/ad) Weight (kg/pcs)	Barkod Kodu Barcode Code
50 AGH 050 DO	50	1.50 mm	1,795	2001726
50 AGH 100 DO	100	1.50 mm	2,220	2001727
50 AGH 120 DO	120	1.50 mm	2,342	2001765
50 AGH 160 DO	160	1.50 mm	2,465	2001728
50 AGH 200 DO	200	1.50 mm	3,065	2001729
50 AGH 300 DO	300	1.50 mm	3,910	2001730
50 AGH 400 DO	400	2.00 mm	6,340	2001731
50 AGH 500 DO	500	2.00 mm	7,470	2001732
50 AGH 600 DO	600	2.00 mm	8,595	2001733

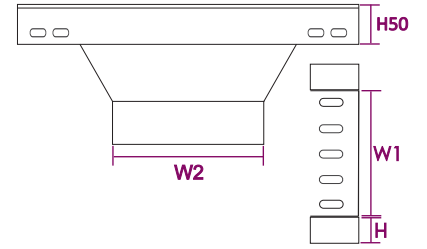

H60

Sipariş Kodu Order Code	W (mm)	T (mm)	Ağırlık (kg/ad) Weight (kg/pcs)	Barkod Kodu Barcode Code
60 AGH 100 DO	100	1.50 mm	2,140	2001741
60 AGH 120 DO	120	1.50 mm	2,525	2001766
60 AGH 160 DO	160	1.50 mm	2,910	2001742
60 AGH 200 DO	200	1.50 mm	3,250	2001743
60 AGH 300 DO	300	2.00 mm	4,095	2001744
60 AGH 400 DO	400	2.00 mm	6,590	2001745
60 AGH 500 DO	500	2.00 mm	7,715	2001746
60 AGH 600 DO	600	2.00 mm	8,840	2001747

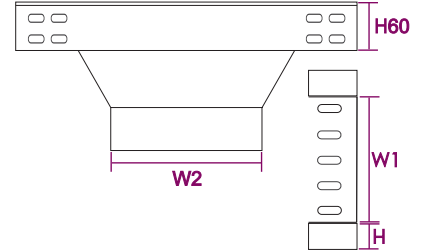

H100

Sipariş Kodu Order Code	W (mm)	T (mm)	Ağırlık (kg/ad) Weight (kg/pcs)	Barkod Kodu Barcode Code
100 AGH 100 DO	100	1.50 mm	3,150	2001755
100 AGH 120 DO	120	1.50 mm	3,405	2001767
100 AGH 160 DO	160	1.50 mm	3,660	2001756
100 AGH 200 DO	200	1.50 mm	4,000	2001757
100 AGH 300 DO	300	2.00 mm	4,485	2001758
100 AGH 400 DO	400	2.00 mm	7,590	2001759
100 AGH 500 DO	500	2.00 mm	8,715	2001760
100 AGH 600 DO	600	2.00 mm	9,840	2001761

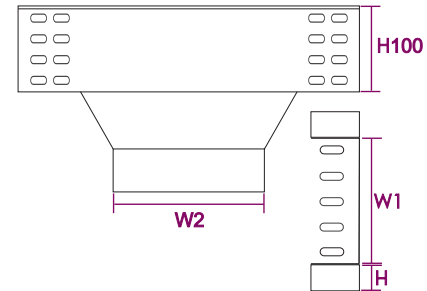

H = YÜKSEKLİK = HEIGHT / W = GENİŞLİK = WIDTH / T = KALINLIK = THICKNESS

ARTIM METAL ELEKTRİK A.Ş.

- * Farklı kalınlık ve ölçülerde üretim yapılabılır.
- * Malzeme ağırlıkları yaklaşık değerlerdir, ± %10 değişiklik gösterebilir.
- * Malzeme kalınlık toleransı ± %10 dur.
- * Lütfen siparişlerinizde sipariş kodu veya ürün kodu ve Kaplama şeklini belirtiniz.

- * We can produce cable trays different thickness and dimensions
- * Cable trays are shown approximately weight, they could change ± %10 difference.
- * Cable trays thickness tolerances are shown ± %10 .
- * Please indicate order code and coating type in your orders.

AGH SERIES

ORTADAN T BAĞLANTI

FRO MIDDLE VERTICAL TEES

SICAK DALDIRMA (SD)

HOT DIP GALVANIZED (SD)

TS EN ISO 1461



H40 = H50 Tek delikli
H40 = H50 One hole

H40

Sipariş Kodu Order Code	W (mm)	T (mm)	Ağırlık (kg/ad) Weight (kg/pcs)	Barkod Kodu Barcode Code
40 AGH 050 DO	50	1.50 mm	1,775	2001709
40 AGH 100 DO	100	1.50 mm	2,455	2001710
40 AGH 120 DO	120	1.50 mm	2,430	2001711
40 AGH 160 DO	160	1.50 mm	2,800	2001712
40 AGH 200 DO	200	1.50 mm	3,170	2001713
40 AGH 300 DO	300	1.50 mm	4,105	2001714
40 AGH 400 DO	400	2.00 mm	6,710	2001715
40 AGH 500 DO	500	2.00 mm	7,950	2001716
40 AGH 600 DO	600	2.00 mm	9,190	2001717

H50

Sipariş Kodu Order Code	W (mm)	T (mm)	Ağırlık (kg/ad) Weight (kg/pcs)	Barkod Kodu Barcode Code
50 AGH 050 DO	50	1.50 mm	1,975	2001726
50 AGH 100 DO	100	1.50 mm	2,445	2001727
50 AGH 120 DO	120	1.50 mm	2,580	2001765
50 AGH 160 DO	160	1.50 mm	2,715	2001728
50 AGH 200 DO	200	1.50 mm	3,370	2001729
50 AGH 300 DO	300	1.50 mm	4,295	2001730
50 AGH 400 DO	400	2.00 mm	6,975	2001731
50 AGH 500 DO	500	2.00 mm	8,215	2001732
50 AGH 600 DO	600	2.00 mm	9,455	2001733

H60

Sipariş Kodu Order Code	W (mm)	T (mm)	Ağırlık (kg/ad) Weight (kg/pcs)	Barkod Kodu Barcode Code
60 AGH 100 DO	100	1.50 mm	2,650	2001741
60 AGH 120 DO	120	1.50 mm	2,927	2001766
60 AGH 160 DO	160	1.50 mm	3,205	2001742
60 AGH 200 DO	200	1.50 mm	3,575	2001743
60 AGH 300 DO	300	1.50 mm	4,505	2001744
60 AGH 400 DO	400	2.00 mm	7,245	2001745
60 AGH 500 DO	500	2.00 mm	8,485	2001746
60 AGH 600 DO	600	2.00 mm	9,725	2001747

H100

Sipariş Kodu Order Code	W (mm)	T (mm)	Ağırlık (kg/ad) Weight (kg/pcs)	Barkod Kodu Barcode Code
100 AGH 100 DO	100	1.50 mm	3,465	2001755
100 AGH 120 DO	120	1.50 mm	3,747	2001767
100 AGH 160 DO	160	1.50 mm	4,030	2001756
100 AGH 200 DO	200	1.50 mm	4,400	2001757
100 AGH 300 DO	300	1.50 mm	5,330	2001758
100 AGH 400 DO	400	2.00 mm	8,345	2001759
100 AGH 500 DO	500	2.00 mm	9,585	2001760
100 AGH 600 DO	600	2.00 mm	10,825	2001761

H = YÜKSEKLİK = HEIGHT / W = GENİŞLİK = WIDTH / T = KALINLIK = THICKNESS

H AGH 100 DO

Yükseklik Kanal Tipi Genişlik Modül
Height Type Width Module

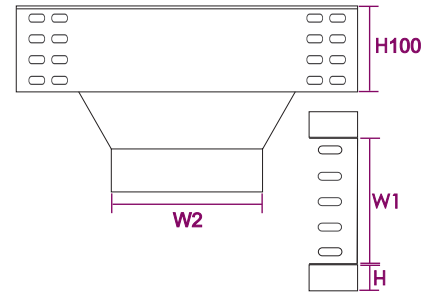
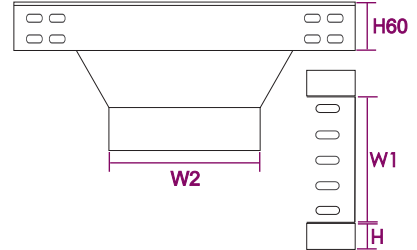
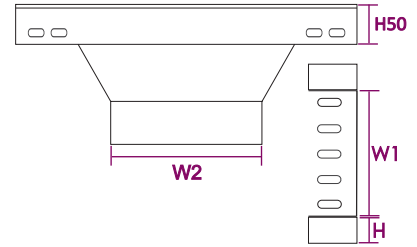
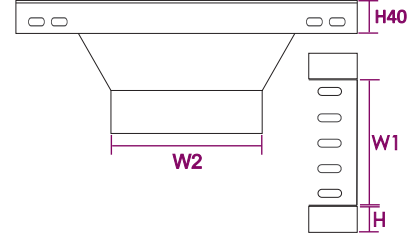

* Farklı kalınlık ve ölçülerde üretim yapılabılır.
* Malzeme ağırlıkları yaklaşık değerlerdir, ± %10 değişiklik gösterebilir.
* Malzeme kalınlık toleransı ± %10 dur.
* Lütfen siparişlerinizde sipariş kodu veya ürün kodu ve kaplama şeklini belirtiniz.

* We can produce cable trays different thickness and dimensions
* Cable trays are shown approximately weight, they could change ± %10 difference.
* Cable trays thickness tolerances are shown ± %10 .
* Please indicate order code and coating type in your orders.

AST & AGH SERIES

KANAL SEPERATÖRLERİ

CABLE SEPARATORS

PREGALVANİZ (PG)
PREGALVANİZ (PG)
TS EN 10346

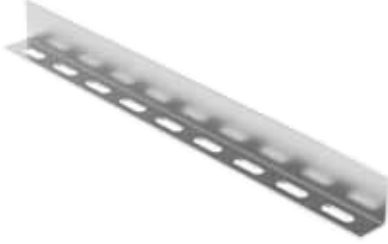

H40 = H50 = H60 = H100 Tek delikli
H40 = H50 = H60 = H100 One hole



H40				
Sipariş Kodu Order Code	L (mm)	T (mm)	Ağırlık (kg/m) Weight (kg/m)	Barkod Kodu Barcode Code
40 AST SP-12	3.000	1.20 mm	0,620	2001800
40 AST SP-15	3.000	1.50 mm	0,714	2001801

H50				
Sipariş Kodu Order Code	L (mm)	T (mm)	Ağırlık (kg/m) Weight (kg/m)	Barkod Kodu Barcode Code
50 AST SP-12	3.000	1.20 mm	0,707	2001803
50 AST SP-15	3.000	1.50 mm	0,824	2001804

H60				
Sipariş Kodu Order Code	L (mm)	T (mm)	Ağırlık (kg/m) Weight (kg/m)	Barkod Kodu Barcode Code
60 AST SP-15	3.000	1.50 mm	0,935	2001806

H75				
Sipariş Kodu Order Code	L (mm)	T (mm)	Ağırlık (kg/m) Weight (kg/m)	Barkod Kodu Barcode Code
75 AST SP-15	3.000	1.50 mm	1,099	2001811

H100				
Sipariş Kodu Order Code	L (mm)	T (mm)	Ağırlık (kg/m) Weight (kg/m)	Barkod Kodu Barcode Code
100 AST SP-15	3.000	1.50 mm	1,373	2001808

H = YÜKSEKLİK = HEIGHT / L = BOY = LENGTH / T = KALINLIK = THICKNESS

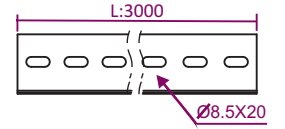
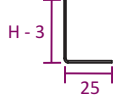
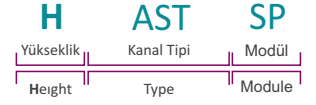

H40				
Sipariş Kodu Order Code	L (mm)	T (mm)	Ağırlık (kg/m) Weight (kg/m)	Barkod Kodu Barcode Code
40 AGH SP-15	3.000	1.50 mm	0,824	2001802

H50				
Sipariş Kodu Order Code	L (mm)	T (mm)	Ağırlık (kg/m) Weight (kg/m)	Barkod Kodu Barcode Code
50 AGH SP-15	3.000	1.50 mm	0,934	2001805

H60				
Sipariş Kodu Order Code	L (mm)	T (mm)	Ağırlık (kg/m) Weight (kg/m)	Barkod Kodu Barcode Code
60 AGH SP-15	3.000	1.50 mm	1,045	2001807

H75				
Sipariş Kodu Order Code	L (mm)	T (mm)	Ağırlık (kg/m) Weight (kg/m)	Barkod Kodu Barcode Code
75 AGH SP-15	3.000	1.50 mm	1,209	2001810

H100				
Sipariş Kodu Order Code	L (mm)	T (mm)	Ağırlık (kg/m) Weight (kg/m)	Barkod Kodu Barcode Code
100 AGH SP-15	3.000	1.50 mm	1,483	2001809

H = YÜKSEKLİK = HEIGHT / L = BOY = LENGTH / T = KALINLIK = THICKNESS

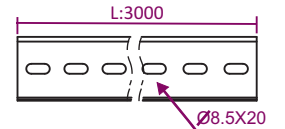
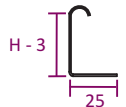

H40 = H50 = H60 = H100 Tek delikli
H40 = H50 = H60 = H100 One hole

ARTIM METAL ELEKTRİK A.Ş.

- * Farklı kalınlık ve ölçülerde üretim yapıla bilinir.
- * Malzeme ağırlıkları yaklaşık değerlerdir, \pm %10 değişiklik gösterebilir.
- * Malzeme kalınlık toleransı \pm %10 dur.
- * Lütfen siparişlerinizde sipariş kodu veya ürün kodu ve Kaplama şeklini belirtiniz.

- * We can produce cable trays different thickness and dimensions
- * Cable trays are shown approximately weight, they could change \pm %10 difference.
- * Cable trays thickness tolerances are shown \pm %10 .
- * Please indicate order code and coating type in your orders.

AST & AGH SERIES

KANAL SEPERATÖRLERİ

CABLE SEPARATORS

SICAK DALDIRMA (SD)

HOT DIP GALVANIZED (SD)

TS EN ISO 1461

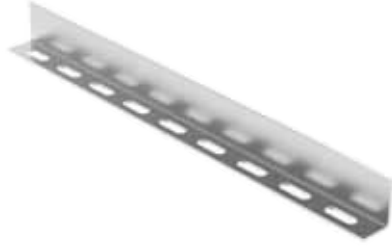

H40				
Sipariş Kodu Order Code	L (mm)	T (mm)	Ağırlık (kg/m) Weight (kg/m)	Barkod Kodu Barcode Code
40 AST SP-12	3.000	1.20 mm	0,682	2001800
40 AST SP-15	3.000	1.50 mm	0,785	2001801

H50				
Sipariş Kodu Order Code	L (mm)	T (mm)	Ağırlık (kg/m) Weight (kg/m)	Barkod Kodu Barcode Code
50 AST SP-12	3.000	1.20 mm	0,778	2001803
50 AST SP-15	3.000	1.50 mm	0,906	2001804

H60				
Sipariş Kodu Order Code	L (mm)	T (mm)	Ağırlık (kg/m) Weight (kg/m)	Barkod Kodu Barcode Code
60 AST SP-15	3.000	1.50 mm	1,028	2001806

H75				
Sipariş Kodu Order Code	L (mm)	T (mm)	Ağırlık (kg/m) Weight (kg/m)	Barkod Kodu Barcode Code
75 AST SP-15	3.000	1.50 mm	1,209	2001811

H100				
Sipariş Kodu Order Code	L (mm)	T (mm)	Ağırlık (kg/m) Weight (kg/m)	Barkod Kodu Barcode Code
100 AST SP-15	3.000	1.50 mm	1,510	2001808

H = YÜKSEKLİK = HEIGHT / L = BOY = LENGTH / T = KALINLIK = THICKNESS

H40 = H50 = H60 = H100 Tek delikli
H40 = H50 = H60 = H100 One hole

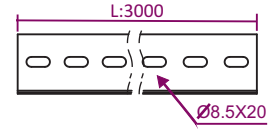
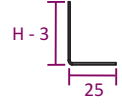
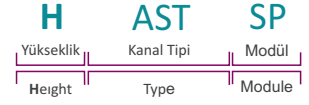

H40				
Sipariş Kodu Order Code	L (mm)	T (mm)	Ağırlık (kg/m) Weight (kg/m)	Barkod Kodu Barcode Code
40 AGH 03S	3.000	1.50 mm	0,906	2001802

H50				
Sipariş Kodu Order Code	L (mm)	T (mm)	Ağırlık (kg/m) Weight (kg/m)	Barkod Kodu Barcode Code
50 AGH 06S	3.000	1.50 mm	1,027	2001805

H60				
Sipariş Kodu Order Code	L (mm)	T (mm)	Ağırlık (kg/m) Weight (kg/m)	Barkod Kodu Barcode Code
60 AGH 08S	3.000	1.50 mm	1,149	2001807

H100				
Sipariş Kodu Order Code	L (mm)	T (mm)	Ağırlık (kg/m) Weight (kg/m)	Barkod Kodu Barcode Code
100 AGH 10S	3.000	1.50 mm	1,631	2001809

H = YÜKSEKLİK = HEIGHT / L = BOY = LENGTH / T = KALINLIK = THICKNESS

H40 = H50 = H60 = H100 Tek delikli
H40 = H50 = H60 = H100 One hole

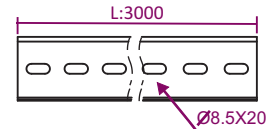
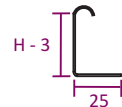

* Farklı kalınlık ve ölçülerde üretim yapıla bilinir.
* Malzeme ağırlıkları yaklaşık değerlerdir, ± %10 değişiklik gösterebilir.
* Malzeme kalınlık toleransı ± %10 dur.
* Lütfen siparişlerinizde sipariş kodu veya ürün kodu ve Kaplama şeklini belirtiniz.

* We can produce cable trays different thickness and dimensions
* Cable trays are shown approximately weight, they could change ± %10 difference.
* Cable trays thickness tolerances are shown ± %10 .
* Please indicate order code and coating type in your orders.

AGH SERIES

EK ELEMANI

STRAIGHT CONNECTION COUPLER

PREGALVANIZ (PG)
PREGALVANIZ (PG)
TS EN 10346



H40 = H50 = Tek delikli
H40 = H50 = One hole

H60 = İki delikli
H60 = Two holes

H100 = Dört delikli
H100 = Four holes

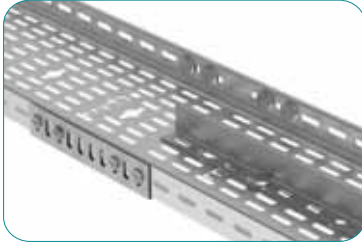

H40

Sipariş Kodu Order Code	T (mm)	Ağırlık (kg/ad) Weight (kg/pcs)	Paket İçi(ad) In Package(Pcs)	Barkod Kodu Barcode Code
40 AST 1	1.20 mm	0,088	300	2001001
40 AST 2	1.50 mm	0,108	250	2001002
40 AST 3	2.00 mm	0,142	200	2001003

H50

Sipariş Kodu Order Code	T (mm)	Ağırlık (kg/ad) Weight (kg/pcs)	Paket İçi(ad) In Package(Pcs)	Barkod Kodu Barcode Code
50 AST 1	1.20 mm	0,110	250	2001008
50 AST 2	1.50 mm	0,135	200	2001009
50 AST 3	2.00 mm	0,180	150	2001010

H60

Sipariş Kodu Order Code	T (mm)	Ağırlık (kg/ad) Weight (kg/pcs)	Paket İçi(ad) In Package(Pcs)	Barkod Kodu Barcode Code
60 AST 1	1.20 mm	0,125	200	2001015
60 AST 2	1.50 mm	0,157	-	2001016
60 AST 3	2.00 mm	0,205	-	2001017

H100

Sipariş Kodu Order Code	T (mm)	Ağırlık (kg/ad) Weight (kg/pcs)	Paket İçi(ad) In Package(Pcs)	Barkod Kodu Barcode Code
100 AST 1	1.20 mm	0,192	-	2001019
100 AST 2	1.50 mm	0,240	-	2001020
100 AST 3	2.00 mm	0,320	-	2001021

H = YÜKSEKLİK = HEIGHT / T = KALINLIK = THICKNESS / L = BOY = LENGTH = 175 mm

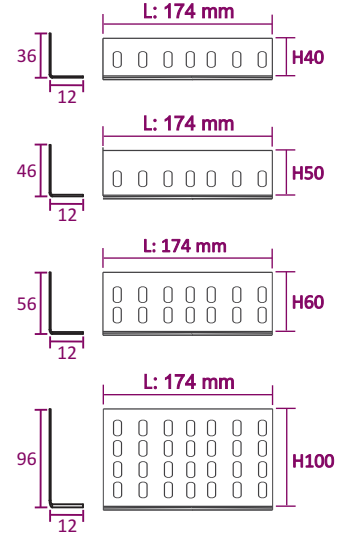

1 Adet H40 - H50 Ek montajı için;
M8x15 Cıvata 4 Adet M8 Somun 4 Adet kullanılmalıdır.
1 Adet H60 - H75 - H100 Ek montajı için;
M8x15 Cıvata 8 Adet M8 Somun 8 Adet kullanılmalıdır.

For the installation of 1 H40 - H50 Splice;
M8x15 Bolts 4 Pieces M8 Nuts 4 Pieces must be used.
1 piece H60 - H75 - H100 for additional assembly;
M8x15 Bolts 8 Pieces M8 Nuts 8 Pieces should be used.

H40

Sipariş Kodu Order Code	T (mm)	Ağırlık (kg/ad) Weight (kg/pcs)	Paket İçi(ad) In Package(Pcs)	Barkod Kodu Barcode Code
40 AST 2A	1.50 mm	0,135	-	2001007

H50

Sipariş Kodu Order Code	T (mm)	Ağırlık (kg/ad) Weight (kg/pcs)	Paket İçi(ad) In Package(Pcs)	Barkod Kodu Barcode Code
50 AST 2A	1.50 mm	0,160	-	2001014

H60

Sipariş Kodu Order Code	T (mm)	Ağırlık (kg/ad) Weight (kg/pcs)	Paket İçi(ad) In Package(Pcs)	Barkod Kodu Barcode Code
60 AST 2A	1.50 mm	0,180	-	2001018

H100

Sipariş Kodu Order Code	T (mm)	Ağırlık (kg/ad) Weight (kg/pcs)	Paket İçi(ad) In Package(Pcs)	Barkod Kodu Barcode Code
100 AST 2A	1.50 mm	0,350	-	2001022

H = YÜKSEKLİK = HEIGHT / T = KALINLIK = THICKNESS / L = BOY = LENGTH = 175 mm

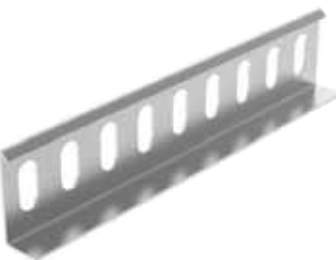
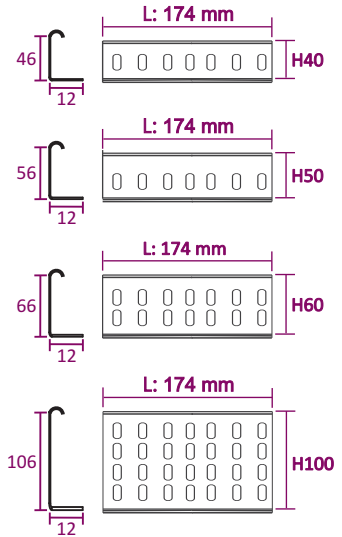

H40 = H50 = Tek delikli
H40 = H50 = One hole

H60 = İki delikli
H60 = Two holes

H100 = Dört delikli
H100 = Four holes

ARTIM METAL ELEKTRİK A.Ş.

* Farklı kalınlık ve ölçülerde üretim yapılabılır.
* Malzeme ağırlıkları yaklaşık değerlerdir, \pm %10 değişiklik gösterebilir.
* Malzeme kalınlık toleransı \pm %10 dur.
* Lütfen siparişlerinizde sipariş kodu veya ürün kodu ve Kaplama şeklini belirtiniz.

* We can produce cable trays different thickness and dimensions
* Cable trays are shown approximately weight, they could change \pm %10 difference.
* Cable trays thickness tolerances are shown \pm %10 .
* Please indicate order code and coating type in your orders.

AGH SERIES

EK ELEMANI

STRAIGHT CONNECTION COUPLER

SICAK DALDIRMA (SD)

HOT DIP GALVANIZED (SD)

TS EN ISO 1461



H40 = H50 = Tek delikli
H40 = H50 = One hole

H60 = İki delikli
H60 = Two holes

H100 = Dört delikli
H100 = Four holes

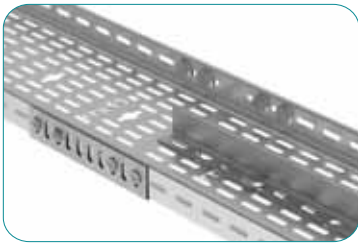

H40				
Sipariş Kodu Order Code	T (mm)	Ağırlık (kg/ad) Weight (kg/pcs)	Paket İçi(ad) in Package(Pcs)	Barkod Kodu Barcode Code
40 AST 1	1.20 mm	0,096	300	2001001
40 AST 2	1.50 mm	0,120	250	2001002
40 AST 3	2.00 mm	0,160	200	2001003

H50				
Sipariş Kodu Order Code	T (mm)	Ağırlık (kg/ad) Weight (kg/pcs)	Paket İçi(ad) in Package(Pcs)	Barkod Kodu Barcode Code
50 AST 1	1.20 mm	0,120	250	2001008
50 AST 2	1.50 mm	0,150	200	2001009
50 AST 3	2.00 mm	0,200	150	2001010

H60				
Sipariş Kodu Order Code	T (mm)	Ağırlık (kg/ad) Weight (kg/pcs)	Paket İçi(ad) in Package(Pcs)	Barkod Kodu Barcode Code
60 AST 1	1.20 mm	0,135	200	2001015
60 AST 2	1.50 mm	0,169	-	2001016
60 AST 3	2.00 mm	0,225	-	2001017

H100				
Sipariş Kodu Order Code	T (mm)	Ağırlık (kg/ad) Weight (kg/pcs)	Paket İçi(ad) in Package(Pcs)	Barkod Kodu Barcode Code
100 AST 1	1.20 mm	0,212	-	2001019
100 AST 2	1.50 mm	0,265	-	2001020
100 AST 3	2.00 mm	0,350	-	2001021

H = YÜKSEKLİK = HEIGHT / T = KALINLIK = THICKNESS / L = BOY = LENGTH = 175 mm

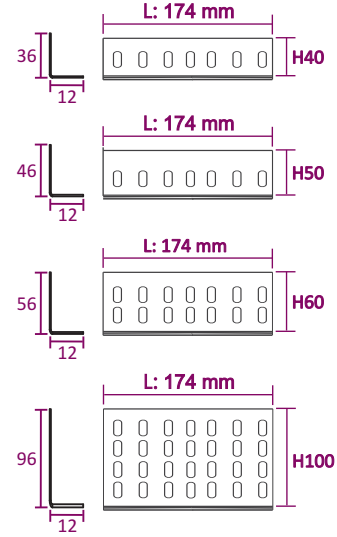

1 Adet H40 - H50 Ek montajı için;
M8x15 Civata 4 Adet M8 Somun 4 Adet kullanılmalıdır.
1 Adet H60 - H75 - H100 Ek montajı için;
M8x15 Civata 8 Adet M8 Somun 8 Adet kullanılmalıdır.

For the installation of 1 H40 - H50 Splice;
M8x15 Bolts 4 Pieces M8 Nuts 4 Pieces must be used.
1 piece H60 - H75 - H100 for additional assembly;
M8x15 Bolts 8 Pieces M8 Nuts 8 Pieces should be used.

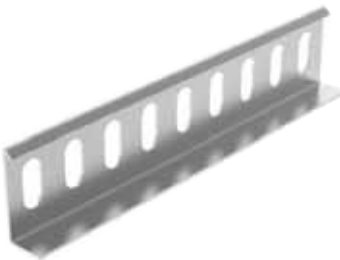

H40 = H50 = Tek delikli
H40 = H50 = One hole

H60 = İki delikli
H60 = Two holes

H100 = Dört delikli
H100 = Four holes

H40				
Sipariş Kodu Order Code	T (mm)	Ağırlık (kg/ad) Weight (kg/pcs)	Paket İçi(ad) in Package(Pcs)	Barkod Kodu Barcode Code
40 AST 2A	1.50 mm	0,150	-	2001007

H50				
Sipariş Kodu Order Code	T (mm)	Ağırlık (kg/ad) Weight (kg/pcs)	Paket İçi(ad) in Package(Pcs)	Barkod Kodu Barcode Code
50 AST 2A	1.50 mm	0,175	-	2001014

H60				
Sipariş Kodu Order Code	T (mm)	Ağırlık (kg/ad) Weight (kg/pcs)	Paket İçi(ad) in Package(Pcs)	Barkod Kodu Barcode Code
60 AST 2A	1.50 mm	0,195	-	2001018

H100				
Sipariş Kodu Order Code	T (mm)	Ağırlık (kg/ad) Weight (kg/pcs)	Paket İçi(ad) in Package(Pcs)	Barkod Kodu Barcode Code
100 AST 2A	1.50 mm	0,390	-	2001022

H = YÜKSEKLİK = HEIGHT / T = KALINLIK = THICKNESS / L = BOY = LENGTH = 175 mm

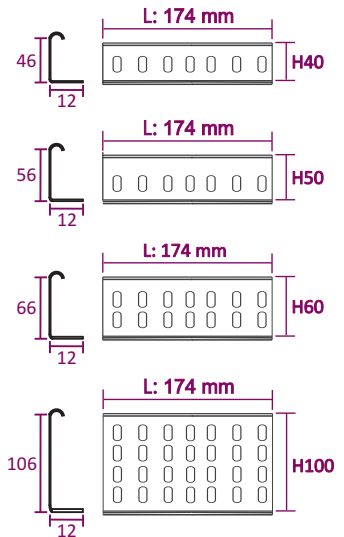

* Farklı kalınlık ve ölçülerde üretim yapılabılır.
* Malzeme ağırlıkları yaklaşık değerlerdir, ± %10 değişiklik gösterebilir.
* Malzeme kalınlık toleransı ± %10 dur.
* Lütfen siparişlerinizde sipariş kodu veya ürün kodu ve Kaplama şeklini belirtiniz.

* We can produce cable trays different thickness and dimensions
* Cable trays are shown approximately weight, they could change ± %10 difference.
* Cable trays thickness tolerances are shown ± %10 .
* Please indicate order code and coating type in your orders.

art

 WWW.ARTIMMETAL.COM

POWER CARRYING SOLUTIONS

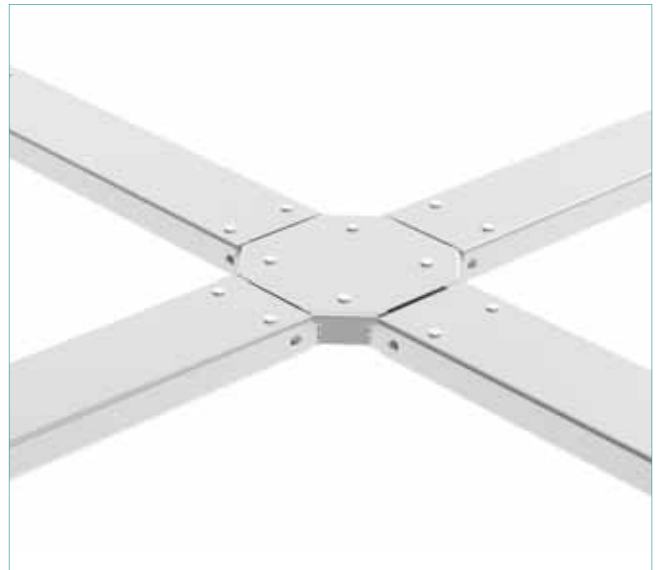

art

POWER CARRYING SOLUTIONS



TRUNKING TİP KABLO KANALLARI

TRUNKING TYPE CABLE TRAYS



H50 ATR SERIES

TRUNKING TIP KABLO KANALI

TRUNKING TYPE CABLE TRAYS

PREGALVANİZ (PG)
PREGALVANIZED (PG)
TS EN 10346

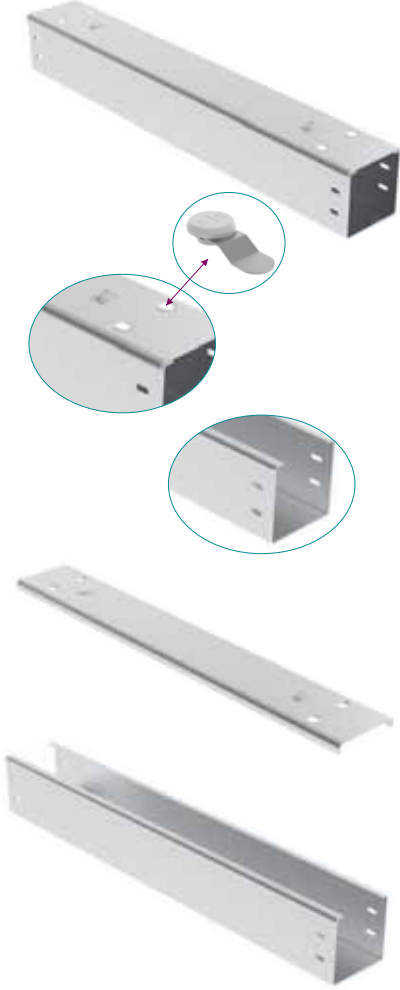

0.60 mm

Sipariş Kodu Order Code	W (mm)	T (mm)	Ağırlık (kg/m) Weight (kg/m)	Barkod Kodu Barcode Code
50 ATR 050-06	50	0.60 mm	0,772	2006000
ATRK 050-06	50	0.60 mm	0,377	2000800
50 ATR 075-06	75	0.60 mm	0,890	2006001
ATRK 075-06	75	0.60 mm	0,495	2000801
50 ATR 100-06	100	0.60 mm	1,008	2006002
ATRK 100-06	100	0.60 mm	0,612	2000802
50 ATR 150-06	150	0.60 mm	1,243	2006003
ATRK 150-06	150	0.60 mm	0,848	2000803
50 ATR 200-06	200	0.60 mm	1,479	2006004
ATRK 200-06	200	0.60 mm	1,083	2000804

0.80 mm

Sipariş Kodu Order Code	W (mm)	T (mm)	Ağırlık (kg/m) Weight (kg/m)	Barkod Kodu Barcode Code
50 ATR 050-08	50	0.80 mm	1,030	2006010
ATRK 050-08	50	0.80 mm	0,502	2000810
50 ATR 075-08	75	0.80 mm	1,187	2006011
ATRK 075-08	75	0.80 mm	0,659	2000811
50 ATR 100-08	100	0.80 mm	1,344	2006012
ATRK 100-08	100	0.80 mm	0,816	2000812
50 ATR 150-08	150	0.80 mm	1,658	2006013
ATRK 150-08	150	0.80 mm	1,130	2000813
50 ATR 200-08	200	0.80 mm	1,972	2006014
ATRK 200-08	200	0.80 mm	1,444	2000814

1.20 mm

Sipariş Kodu Order Code	W (mm)	T (mm)	Ağırlık (kg/m) Weight (kg/m)	Barkod Kodu Barcode Code
50 ATR 050-12	50	1.20 mm	1,545	2006020
ATRK 050-12	50	1.20 mm	0,754	2000820
50 ATR 075-12	75	1.20 mm	1,780	2006021
ATRK 075-12	75	1.20 mm	0,989	2000821
50 ATR 100-12	100	1.20 mm	2,016	2006022
ATRK 100-12	100	1.20 mm	1,225	2000822
50 ATR 150-12	150	1.20 mm	2,487	2006023
ATRK 150-12	150	1.20 mm	1,696	2000823
50 ATR 200-12	200	1.20 mm	2,958	2006024
ATRK 200-12	200	1.20 mm	2,167	2000824

1.50 mm

Sipariş Kodu Order Code	W (mm)	T (mm)	Ağırlık (kg/m) Weight (kg/m)	Barkod Kodu Barcode Code
50 ATR 050-15	50	1.50 mm	1,802	2006025
ATRK 050-15	50	1.50 mm	0,879	2000825
50 ATR 075-15	75	1.50 mm	2,077	2006026
ATRK 075-15	75	1.50 mm	1,154	2000826
50 ATR 100-15	100	1.50 mm	2,352	2006027
ATRK 100-15	100	1.50 mm	1,429	2000827
50 ATR 150-15	150	1.50 mm	2,901	2006028
ATRK 150-15	150	1.50 mm	1,978	2000828
50 ATR 200-15	200	1.50 mm	3,451	2006029
ATRK 200-15	200	1.50 mm	2,528	2000829

50 ATR 100-10

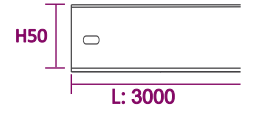
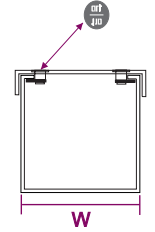

Standart uzunluk L:3000 mm
Toplu miktarlarda Özel ölçüler yapılabilir.
Standard Length L:3000 mm
Custom sizes can be made in bulk quantities.

ARTIM METAL ELEKTRİK A.Ş.

H = YÜKSEKLİK = HEIGHT / W = GENİŞLİK = WIDTH / T = KALINLIK = THICKNESS

- * Farklı kalınlık ve ölçülerde üretim yapılabılır.
- * Malzeme ağırlıkları yaklaşık değerlerdir, \pm %10 değişiklik gösterebilir.
- * Malzeme kalınlık toleransı \pm %10 dur.
- * Lütfen siparişlerinizde sipariş kodu veya ürün kodu ve Kaplama şeklini belirtiniz.

- * We can produce cable trays different thickness and dimensions
- * Cable trays are shown approximately weight, they could change \pm %10 difference.
- * Cable trays thickness tolerances are shown \pm %10 .
- * Please indicate order code and coating type in your orders.

H50 ATR SERIES

TRUNKING TIP KABLO KANALI

TRUNKING TYPE CABLE TRAYS

SICAK DALDIRMA (SD)

HOT DIP GALVANIZED (HDG)

TS EN ISO 1461

0.70 mm

Sipariş Kodu Order Code	W (mm)	T (mm)	Ağırlık (kg/m) Weight (kg/m)	Barkod Kodu Barcode Code
50 ATR 050-07	50	0.70 mm	0,982	2006005
ATRK 050-07	50	0.70 mm	0,479	2000805
50 ATR 075-07	75	0.70 mm	1,132	2006006
ATRK 075-07	75	0.70 mm	0,629	2000806
50 ATR 100-07	100	0.70 mm	1,282	2006007
ATRK 100-07	100	0.70 mm	0,779	2000807
50 ATR 150-07	150	0.70 mm	1,581	2006008
ATRK 150-07	150	0.70 mm	1,078	2000808
50 ATR 200-07	200	0.70 mm	1,881	2006009
ATRK 200-07	200	0.70 mm	1,378	2000809

1.00 mm

Sipariş Kodu Order Code	W (mm)	T (mm)	Ağırlık (kg/m) Weight (kg/m)	Barkod Kodu Barcode Code
50 ATR 050-10	50	1.00 mm	1,403	2006015
ATRK 050-10	50	1.00 mm	0,685	2000815
50 ATR 075-10	75	1.00 mm	1,617	2006016
ATRK 075-10	75	1.00 mm	0,898	2000816
50 ATR 100-10	100	1.00 mm	1,831	2006017
ATRK 100-10	100	1.00 mm	1,112	2000817
50 ATR 150-10	150	1.00 mm	2,259	2006018
ATRK 150-10	150	1.00 mm	1,540	2000818
50 ATR 200-10	200	1.00 mm	2,687	2006019
ATRK 200-10	200	1.00 mm	1,968	2000819

1.20 mm

Sipariş Kodu Order Code	W (mm)	T (mm)	Ağırlık (kg/m) Weight (kg/m)	Barkod Kodu Barcode Code
50 ATR 050-12	50	1.20 mm	1,684	2006020
ATRK 050-12	50	1.20 mm	0,821	2000820
50 ATR 075-12	75	1.20 mm	1,941	2006021
ATRK 075-12	75	1.20 mm	1,078	2000821
50 ATR 100-12	100	1.20 mm	2,197	2006022
ATRK 100-12	100	1.20 mm	1,335	2000822
50 ATR 150-12	150	1.20 mm	2,711	2006023
ATRK 150-12	150	1.20 mm	1,848	2000823
50 ATR 200-12	200	1.20 mm	3,224	2006024
ATRK 200-12	200	1.20 mm	2,362	2000824

1.50 mm

Sipariş Kodu Order Code	W (mm)	T (mm)	Ağırlık (kg/m) Weight (kg/m)	Barkod Kodu Barcode Code
50 ATR 050-15	50	1.50 mm	1,965	2006025
ATRK 050-15	50	1.50 mm	0,958	2000825
50 ATR 075-15	75	1.50 mm	2,264	2006026
ATRK 075-15	75	1.50 mm	1,258	2000826
50 ATR 100-15	100	1.50 mm	2,564	2006027
ATRK 100-15	100	1.50 mm	1,557	2000827
50 ATR 150-15	150	1.50 mm	3,162	2006028
ATRK 150-15	150	1.50 mm	2,156	2000828
50 ATR 200-15	200	1.50 mm	3,761	2006029
ATRK 200-15	200	1.50 mm	2,755	2000829

H = YÜKSEKLİK = HEIGHT / W = GENİŞLİK = WIDTH / T = KALINLIK = THICKNESS

50 ATR 100-10

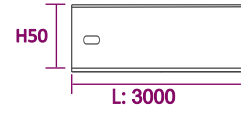
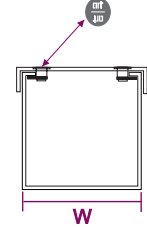

Standart uzunluk L:3000 mm
Toplu miktarlarda Özel ölçüler yapılabilir.
Standard Length L:3000 mm
Custom sizes can be made in bulk quantities.

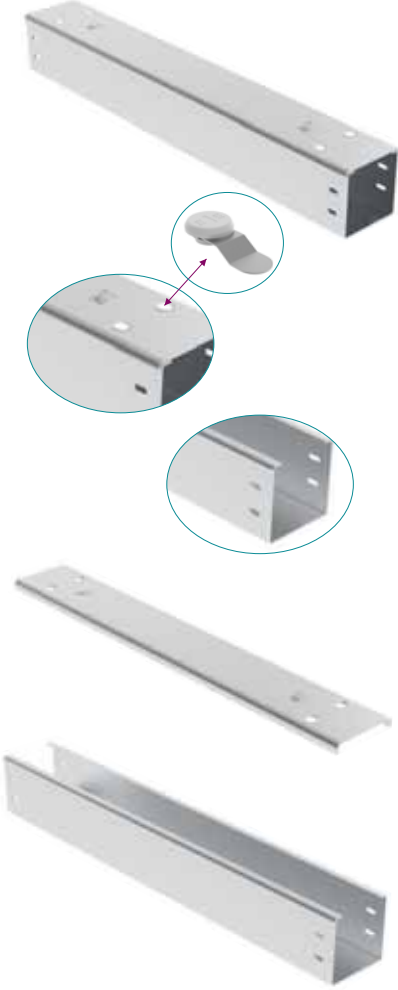

* Farklı kalınlık ve ölçülerde üretim yapılabılır.
* Malzeme ağırlıkları yaklaşık değerlerdir, ± %10 değişiklik gösterebilir.
* Malzeme kalınlık toleransı ± %10 dur.
* Lütfen siparişlerinizde sipariş kodu veya ürün kodu ve Kaplama şeklini belirtiniz.

* We can produce cable trays different thickness and dimensions
* Cable trays are shown approximately weight, they could change ± %10 difference.
* Cable trays thickness tolerances are shown ± %10 .
* Please indicate order code and coating type in your orders.

H75 ATR SERIES

TRUNKING TIP KABLO KANALI

TRUNKING TYPE CABLE TRAYS

PREGALVANİZ (PG)
PREGALVANIZED (PG)
TS EN 10346

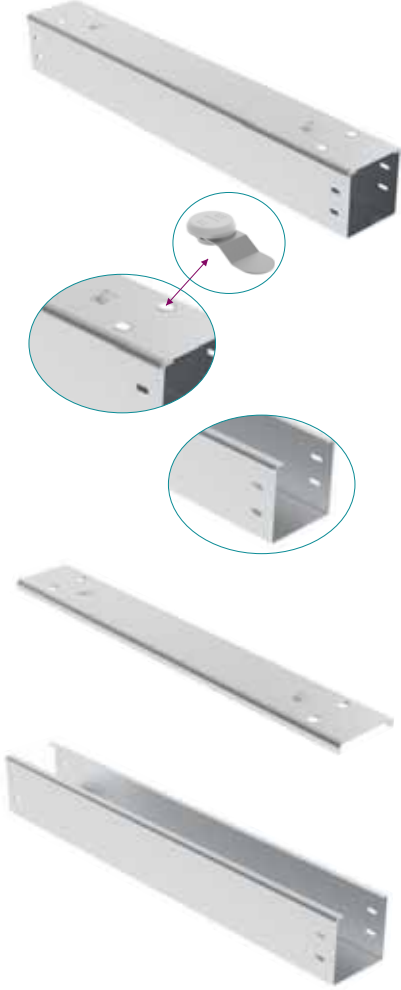

0.60 mm

Sipariş Kodu Order Code	W (mm)	T (mm)	Ağırlık (kg/m) Weight (kg/m)	Barkod Kodu Barcode Code
75 ATR 075-06	75	0.60 mm	1,126	2006030
ATRK 075-06	75	0.60 mm	0,495	2000801
75 ATR 100-06	100	0.60 mm	1,243	2006031
ATRK 100-06	100	0.60 mm	0,612	2000802
75 ATR 150-06	150	0.60 mm	1,479	2006032
ATRK 150-06	150	0.60 mm	0,848	2000803
75 ATR 200-06	200	0.60 mm	1,714	2006033
ATRK 200-06	200	0.60 mm	1,083	2000804

0.80 mm

Sipariş Kodu Order Code	W (mm)	T (mm)	Ağırlık (kg/m) Weight (kg/m)	Barkod Kodu Barcode Code
75 ATR 075-08	75	0.80 mm	1,501	2006038
ATRK 075-08	75	0.80 mm	0,659	2000811
75 ATR 100-08	100	0.80 mm	1,658	2006039
ATRK 100-08	100	0.80 mm	0,816	2000812
75 ATR 150-08	150	0.80 mm	1,972	2006040
ATRK 150-08	150	0.80 mm	1,130	2000813
75 ATR 200-08	200	0.80 mm	2,286	2006041
ATRK 200-08	200	0.80 mm	1,444	2000814

1.20 mm

Sipariş Kodu Order Code	W (mm)	T (mm)	Ağırlık (kg/m) Weight (kg/m)	Barkod Kodu Barcode Code
75 ATR 075-12	75	1.20 mm	2,251	2006046
ATRK 075-12	75	1.20 mm	0,989	2000821
75 ATR 100-12	100	1.20 mm	2,487	2006047
ATRK 100-12	100	1.20 mm	1,225	2000822
75 ATR 150-12	150	1.20 mm	2,958	2006048
ATRK 150-12	150	1.20 mm	1,696	2000823
75 ATR 200-12	200	1.20 mm	3,429	2006049
ATRK 200-12	200	1.20 mm	2,167	2000824

1.50 mm

Sipariş Kodu Order Code	W (mm)	T (mm)	Ağırlık (kg/m) Weight (kg/m)	Barkod Kodu Barcode Code
75 ATR 075-15	75	1.50 mm	2,627	2006050
ATRK 075-15	75	1.50 mm	1,154	2000826
75 ATR 100-15	100	1.50 mm	2,901	2006051
ATRK 100-15	100	1.50 mm	1,429	2000827
75 ATR 150-15	150	1.50 mm	3,451	2006052
ATRK 150-15	150	1.50 mm	1,978	2000828
75 ATR 200-15	200	1.50 mm	4,000	2006053
ATRK 200-15	200	1.50 mm	2,528	2000829

H = YÜKSEKLİK = HEIGHT / W = GENİŞLİK = WIDTH / T = KALINLIK = THICKNESS

75 ATR 100-10

Yükseklik | Kanal Tipi | Genişlik | Kalınlık
Height | Type | Width | Thickness

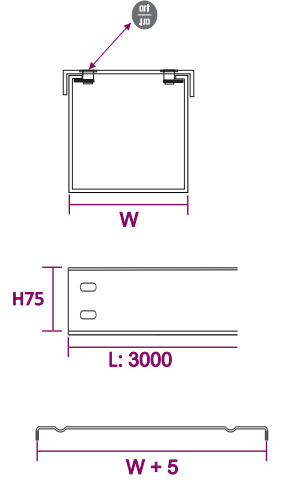

Standart uzunluk L:3000 mm
Toplu miktarlarda Özel ölçüler yapılabilir.
Standard Length L:3000 mm
Custom sizes can be made in bulk quantities.

ARTIM METAL ELEKTRİK A.Ş.

* Farklı kalınlık ve ölçülerde üretim yapılabılır.
* Malzeme ağırlıkları yaklaşık değerlerdir, \pm %10 değişiklik gösterebilir.
* Malzeme kalınlık toleransı \pm %10 dur.
* Lütfen siparişlerinizde sipariş kodu veya ürün kodu ve Kaplama şeklini belirtiniz.

* We can produce cable trays different thickness and dimensions
* Cable trays are shown approximately weight, they could change \pm %10 difference.
* Cable trays thickness tolerances are shown \pm %10 .
* Please indicate order code and coating type in your orders.

H75 ATR SERIES

TRUNKING TIP KABLO KANALI

TRUNKING TYPE CABLE TRAYS

SICAK DALDIRMA (SD)

HOT DIP GALVANIZED (HDG)

TS EN ISO 1461

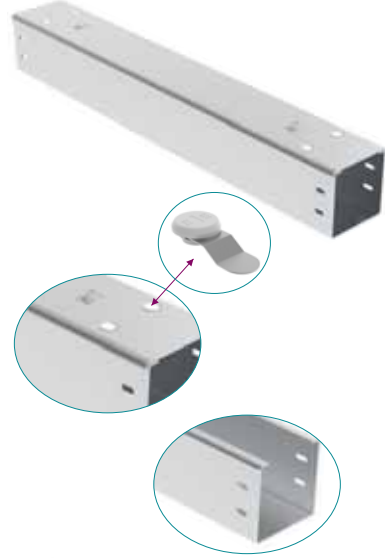

0.70 mm

Sipariş Kodu Order Code	W (mm)	T (mm)	Ağırlık (kg/m) Weight (kg/m)	Barkod Kodu Barcode Code
75 ATTK 075-07	75	0.70 mm	1,432	2006034
AKK 075-07	75	0.70 mm	0,629	2000806
75 ATTK 100-07	100	0.70 mm	1,581	2006035
AKK 100-07	100	0.70 mm	0,779	2000807
75 ATTK 150-07	150	0.70 mm	1,881	2006036
AKK 150-07	150	0.70 mm	1,078	2000808
75 ATTK 200-07	200	0.70 mm	2,180	2006037
AKK 200-07	200	0.70 mm	1,378	2000809

1.00 mm

Sipariş Kodu Order Code	W (mm)	T (mm)	Ağırlık (kg/m) Weight (kg/m)	Barkod Kodu Barcode Code
75 ATTK 075-10	75	1.00 mm	2,045	2006042
AKK 075-10	75	1.00 mm	0,898	2000816
75 ATTK 100-10	100	1.00 mm	2,259	2006043
AKK 100-10	100	1.00 mm	1,112	2000817
75 ATTK 150-10	150	1.00 mm	2,687	2006044
AKK 150-10	150	1.00 mm	1,540	2000818
75 ATTK 200-10	200	1.00 mm	3,115	2006045
AKK 200-10	200	1.00 mm	1,968	2000819

1.20 mm

Sipariş Kodu Order Code	W (mm)	T (mm)	Ağırlık (kg/m) Weight (kg/m)	Barkod Kodu Barcode Code
75 ATTK 075-12	75	1.20 mm	2,454	2006046
AKK 075-12	75	1.20 mm	1,078	2000821
75 ATTK 100-12	100	1.20 mm	2,711	2006047
AKK 100-12	100	1.20 mm	1,335	2000822
75 ATTK 150-12	150	1.20 mm	3,224	2006048
AKK 150-12	150	1.20 mm	1,848	2000823
75 ATTK 200-12	200	1.20 mm	3,737	2006049
AKK 200-12	200	1.20 mm	2,362	2000824

1.50 mm

Sipariş Kodu Order Code	W (mm)	T (mm)	Ağırlık (kg/m) Weight (kg/m)	Barkod Kodu Barcode Code
75 ATTK 075-15	75	1.50 mm	2,863	2006050
AKK 075-15	75	1.50 mm	1,258	2000826
75 ATTK 100-15	100	1.50 mm	3,162	2006051
AKK 100-15	100	1.50 mm	1,557	2000827
75 ATTK 150-15	150	1.50 mm	3,761	2006052
AKK 150-15	150	1.50 mm	2,156	2000828
75 ATTK 200-15	200	1.50 mm	4,360	2006053
AKK 200-15	200	1.50 mm	2,755	2000829

H = YÜKSEKLİK = HEIGHT / W = GENİŞLİK = WIDTH / T = KALINLIK = THICKNESS

75 ATR 100-10

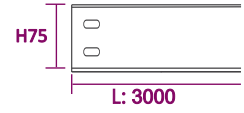
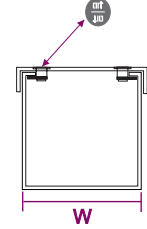

Standart uzunluk L:3000 mm
Toplu miktarlarda Özel ölçüler yapılabilir.
Standard Length L:3000 mm
Custom sizes can be made in bulk quantities.

* Farklı kalınlık ve ölçülerde üretim yapılabılır.
* Malzeme ağırlıkları yaklaşık değerlerdir, ± %10 değişiklik gösterebilir.
* Malzeme kalınlık toleransı ± %10 dur.
* Lütfen siparişlerinizde sipariş kodu veya ürün kodu ve Kaplama şeklini belirtiniz.

* We can produce cable trays different thickness and dimensions
* Cable trays are shown approximately weight, they could change ± %10 difference.
* Cable trays thickness tolerances are shown ± %10 .
* Please indicate order code and coating type in your orders.

H100 ATR SERIES

TRUNKING TIP KABLO KANALLARI

TRUNKING TYPE CABLE TRAYS

PREGALVANIZ (PG)
PREGALVANIZED (PG)
TS EN 10346

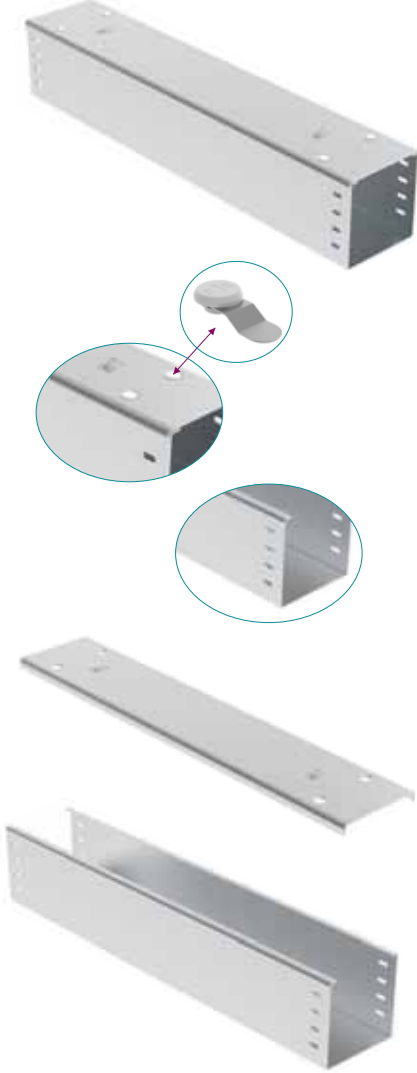

0.60 mm

Sipariş Kodu Order Code	W (mm)	T (mm)	Ağırlık (kg/m) Weight (kg/m)	Barkod Kodu Barcode Code
100 ATR 100-06	100	0.60 mm	1,479	2006054
ATRK 100-06	100	0.60 mm	0,612	2000802
100 ATR 150-06	150	0.60 mm	1,714	2006055
ATRK 150-06	150	0.60 mm	0,848	2000803
100 ATR 200-06	200	0.60 mm	1,950	2006056
ATRK 200-06	200	0.60 mm	1,083	2000804

0.80 mm

Sipariş Kodu Order Code	W (mm)	T (mm)	Ağırlık (kg/m) Weight (kg/m)	Barkod Kodu Barcode Code
100 ATR 100-08	100	0.80 mm	1,972	2006057
ATRK 100-08	100	0.80 mm	0,816	2000812
100 ATR 150-08	150	0.80 mm	2,286	2006058
ATRK 150-08	150	0.80 mm	1,130	2000813
100 ATR 200-08	200	0.80 mm	2,600	2006059
ATRK 200-08	200	0.80 mm	1,444	2000814

1.00 mm

Sipariş Kodu Order Code	W (mm)	T (mm)	Ağırlık (kg/m) Weight (kg/m)	Barkod Kodu Barcode Code
100 ATR 100-10	100	1.00 mm	2,465	2006060
ATRK 100-10	100	1.00 mm	1,021	2000817
100 ATR 150-10	150	1.00 mm	2,857	2006061
ATRK 150-10	150	1.00 mm	1,413	2000818
100 ATR 200-10	200	1.00 mm	3,250	2006062
ATRK 200-10	200	1.00 mm	1,806	2000819

1.20 mm

Sipariş Kodu Order Code	W (mm)	T (mm)	Ağırlık (kg/m) Weight (kg/m)	Barkod Kodu Barcode Code
100 ATR 100-12	100	1.20 mm	2,958	2006063
ATRK 100-12	100	1.20 mm	1,225	2000822
100 ATR 150-12	150	1.20 mm	3,429	2006064
ATRK 150-12	150	1.20 mm	1,696	2000823
100 ATR 200-12	200	1.20 mm	3,900	2006065
ATRK 200-12	200	1.20 mm	2,167	2000824

1.50 mm

Sipariş Kodu Order Code	W (mm)	T (mm)	Ağırlık (kg/m) Weight (kg/m)	Barkod Kodu Barcode Code
100 ATR 100-15	100	1.50 mm	3,451	2006066
ATRK 100-15	100	1.50 mm	1,429	2000827
100 ATR 150-15	150	1.50 mm	4,000	2006067
ATRK 150-15	150	1.50 mm	1,978	2000828
100 ATR 200-15	200	1.50 mm	4,550	2006068
ATRK 200-15	200	1.50 mm	2,528	2000829

H = YÜKSEKLİK = HEIGHT / W = GENİŞLİK = WIDTH / T = KALINLIK = THICKNESS

100 ATR 150-10

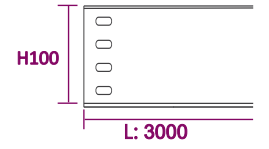
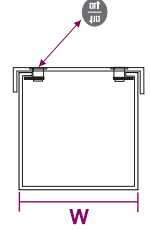

Standart uzunluk L:3000 mm
Toplu miktarlarda Özel ölçüler yapılabilir.
Standard Length L:3000 mm
Custom sizes can be made in bulk quantities.

ARTIM METAL ELEKTRİK A.Ş.

* Farklı kalınlık ve ölçülerde üretim yapılabılır.
* Malzeme ağırlıkları yaklaşık değerlerdir, \pm %10 değişiklik gösterebilir.
* Malzeme kalınlık toleransı \pm %10 dur.
* Lütfen siparişlerinizde sipariş kodu veya ürün kodu ve Kaplama şeklini belirtiniz.

* We can produce cable trays different thickness and dimensions
* Cable trays are shown approximately weight, they could change \pm %10 difference.
* Cable trays thickness tolerances are shown \pm %10 .
* Please indicate order code and coating type in your orders.

H100 ATR SERIES

TRUNKING TIP KABLO KANALI

TRUNKING TYPE CABLE TRAYS

SICAK DALDIRMA (SD)

HOT DIP GALVANIZED (HDG)

TS EN ISO 1461

0.80 mm

Sipariş Kodu Order Code	W (mm)	T (mm)	Ağırlık (kg/m) Weight (kg/m)	Barkod Kodu Barcode Code
100 ATR 100-08	100	0.80 mm	2,149	2006057
ATRK 100-08	100	0.80 mm	0,890	2000812
100 ATR 150-08	150	0.80 mm	2,492	2006058
ATRK 150-08	150	0.80 mm	1,232	2000813
100 ATR 200-08	200	0.80 mm	2,834	2006059
ATRK 200-08	200	0.80 mm	1,574	2000814

1.00 mm

Sipariş Kodu Order Code	W (mm)	T (mm)	Ağırlık (kg/m) Weight (kg/m)	Barkod Kodu Barcode Code
100 ATR 100-10	100	1.00 mm	2,687	2006060
ATRK 100-10	100	1.00 mm	1,112	2000817
100 ATR 150-10	150	1.00 mm	3,115	2006061
ATRK 150-10	150	1.00 mm	1,540	2000818
100 ATR 200-10	200	1.00 mm	3,542	2006062
ATRK 200-10	200	1.00 mm	1,968	2000819

1.20 mm

Sipariş Kodu Order Code	W (mm)	T (mm)	Ağırlık (kg/m) Weight (kg/m)	Barkod Kodu Barcode Code
100 ATR 100-12	100	1.20 mm	3,224	2006063
ATRK 100-12	100	1.20 mm	1,335	2000822
100 ATR 150-12	150	1.20 mm	3,737	2006064
ATRK 150-12	150	1.20 mm	1,848	2000823
100 ATR 200-12	200	1.20 mm	4,251	2006065
ATRK 200-12	200	1.20 mm	2,362	2000824

1.50 mm

Sipariş Kodu Order Code	W (mm)	T (mm)	Ağırlık (kg/m) Weight (kg/m)	Barkod Kodu Barcode Code
100 ATR 100-15	100	1.50 mm	3,761	2006066
ATRK 100-15	100	1.50 mm	1,557	2000827
100 ATR 150-15	150	1.50 mm	4,360	2006067
ATRK 150-15	150	1.50 mm	2,156	2000828
100 ATR 200-15	200	1.50 mm	4,959	2006068
ATRK 200-15	200	1.50 mm	2,755	2000829

2.00 mm

Sipariş Kodu Order Code	W (mm)	T (mm)	Ağırlık (kg/m) Weight (kg/m)	Barkod Kodu Barcode Code
100 ATR 100-20	100	2.00 mm	5,014	2006081
ATRK 100-20	100	2.00 mm	2,076	2000830
100 ATR 150-20	150	2.00 mm	5,813	2006082
ATRK 150-20	150	2.00 mm	2,874	2000831
100 ATR 200-20	200	2.00 mm	6,612	2006083
ATRK 200-20	200	2.00 mm	3,673	2000832

H = YÜKSEKLİK = HEIGHT / W = GENİŞLİK = WIDTH / T = KALINLIK = THICKNESS

100 ATR 150-10

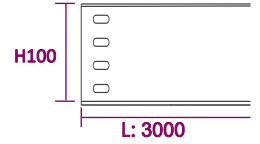
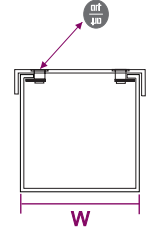
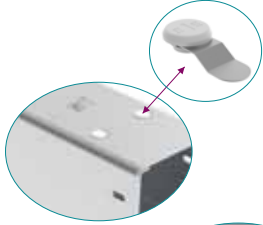

Standart uzunluk L:3000 mm
Toplu miktarlarda Özel ölçüler yapılabilir.
Standard Length L:3000 mm
Custom sizes can be made in bulk quantities.

* Farklı kalınlık ve ölçülerde üretim yapılabılır.
* Malzeme ağırlıkları yaklaşık değerlerdir, \pm %10 değişiklik gösterebilir.
* Malzeme kalınlık toleransı \pm %10 dur.
* Lütfen siparişlerinizde sipariş kodu veya ürün kodu ve Kaplama şeklini belirtiniz.

* We can produce cable trays different thickness and dimensions
* Cable trays are shown approximately weight, they could change \pm %10 difference.
* Cable trays thickness tolerances are shown \pm %10 .
* Please indicate order code and coating type in your orders.

H150 ATR SERIES

TRUNKING TIP KABLO KANALLARI

TRUNKING TYPE CABLE TRAYS

PREGALVANIZ (PG)
PREGALVANIZED (PG)
TS EN 10346

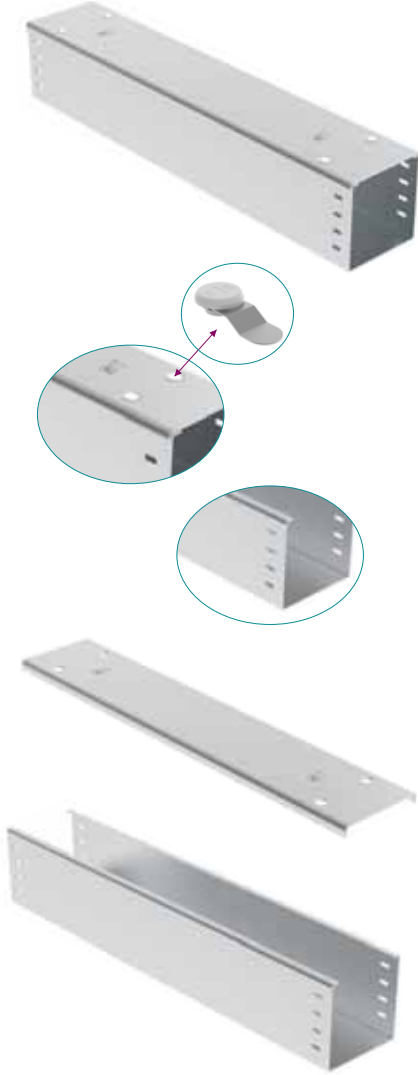

0.60 mm

Sipariş Kodu Order Code	W (mm)	T (mm)	Ağırlık (kg/m) Weight (kg/m)	Barkod Kodu Barcode Code
150 ATR 150-06	150	0.60 mm	2,185	2006069
ATRK 150-06	150	0.60 mm	0,848	2000803
150 ATR 200-06	200	0.60 mm	2,421	2006070
ATRK 200-06	200	0.60 mm	1,083	2000804

0.80 mm

Sipariş Kodu Order Code	W (mm)	T (mm)	Ağırlık (kg/m) Weight (kg/m)	Barkod Kodu Barcode Code
150 ATR 150-08	150	0.80 mm	2,914	2006071
ATRK 150-08	150	0.80 mm	1,130	2000813
150 ATR 200-08	200	0.80 mm	3,228	2006072
ATRK 200-08	200	0.80 mm	1,444	2000814

1.00 mm

Sipariş Kodu Order Code	W (mm)	T (mm)	Ağırlık (kg/m) Weight (kg/m)	Barkod Kodu Barcode Code
150 ATR 150-10	150	1.00 mm	3,642	2006073
ATRK 150-10	150	1.00 mm	1,413	2000818
150 ATR 200-10	200	1.00 mm	4,035	2006074
ATRK 200-10	200	1.00 mm	1,806	2000819

1.20 mm

Sipariş Kodu Order Code	W (mm)	T (mm)	Ağırlık (kg/m) Weight (kg/m)	Barkod Kodu Barcode Code
150 ATR 150-12	150	1.20 mm	4,371	2006075
ATRK 150-12	150	1.20 mm	1,696	2000823
150 ATR 200-12	200	1.20 mm	4,842	2006076
ATRK 200-12	200	1.20 mm	2,167	2000824

1.50 mm

Sipariş Kodu Order Code	W (mm)	T (mm)	Ağırlık (kg/m) Weight (kg/m)	Barkod Kodu Barcode Code
150 ATR 150-15	150	1.50 mm	5,099	2006077
ATRK 150-15	150	1.50 mm	1,978	2000828
150 ATR 200-15	200	1.50 mm	5,649	2006078
ATRK 200-15	200	1.50 mm	2,528	2000829

H = YÜKSEKLİK = HEIGHT / W = GENİŞLİK = WIDTH / T = KALINLIK = THICKNESS

150 ATR 150-10

Yükseklik | Kanal Tipi | Genişlik | Kalınlık
Height | Type | Width | Thickness

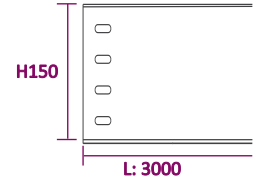
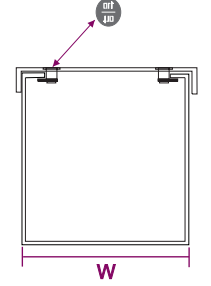

Standart uzunluk L:3000 mm
Toplu miktarlarda Özel ölçüler yapılabilir.
Standard Length L:3000 mm
Custom sizes can be made in bulk quantities.

ARTIM METAL ELEKTRİK A.Ş.

- * Farklı kalınlık ve ölçülerde üretim yapılabılır.
- * Malzeme ağırlıkları yaklaşık değerlerdir, \pm %10 değişiklik gösterebilir.
- * Malzeme kalınlık toleransı \pm %10 dur.
- * Lütfen siparişlerinizde sipariş kodu veya ürün kodu ve Kaplama şeklini belirtiniz.

- * We can produce cable trays different thickness and dimensions
- * Cable trays are shown approximately weight, they could change \pm %10 difference.
- * Cable trays thickness tolerances are shown \pm %10 .
- * Please indicate order code and coating type in your orders.

H150 ATR SERIES

TRUNKING TIP KABLO KANALI

TRUNKING TYPE CABLE TRAYS

SICAK DALDIRMA (SD)

HOT DIP GALVANIZED (HDG)

TS EN ISO 1461

0.80 mm

Sipariş Kodu Order Code	W (mm)	T (mm)	Ağırlık (kg/m) Weight (kg/m)	Barkod Kodu Barcode Code
150 ATR 150-08	150	0.80 mm	3,176	2006071
ATRK 150-08	150	0.80 mm	1,232	2000813
150 ATR 200-08	200	0.80 mm	3,518	2006072
ATRK 200-08	200	0.80 mm	1,574	2000814

1.00 mm

Sipariş Kodu Order Code	W (mm)	T (mm)	Ağırlık (kg/m) Weight (kg/m)	Barkod Kodu Barcode Code
150 ATR 150-10	150	1.00 mm	3,970	2006073
ATRK 150-10	150	1.00 mm	1,540	2000818
150 ATR 200-10	200	1.00 mm	4,398	2006074
ATRK 200-10	200	1.00 mm	1,968	2000819

1.20 mm

Sipariş Kodu Order Code	W (mm)	T (mm)	Ağırlık (kg/m) Weight (kg/m)	Barkod Kodu Barcode Code
150 ATR 150-12	150	1.20 mm	4,764	2006075
ATRK 150-12	150	1.20 mm	1,848	2000823
150 ATR 200-12	200	1.20 mm	5,278	2006076
ATRK 200-12	200	1.20 mm	2,362	2000824

1.50 mm

Sipariş Kodu Order Code	W (mm)	T (mm)	Ağırlık (kg/m) Weight (kg/m)	Barkod Kodu Barcode Code
150 ATR 150-15	150	1.50 mm	5,558	2006077
ATRK 150-15	150	1.50 mm	2,156	2000828
150 ATR 200-15	200	1.50 mm	6,157	2006078
ATRK 200-15	200	1.50 mm	2,755	2000829

2.00 mm

Sipariş Kodu Order Code	W (mm)	T (mm)	Ağırlık (kg/m) Weight (kg/m)	Barkod Kodu Barcode Code
150 ATR 150-20	150	2.00 mm	7,410	2006084
ATRK 150-20	150	2.00 mm	2,874	2000833
150 ATR 200-20	200	2.00 mm	8,209	2006085
ATRK 200-20	200	2.00 mm	3,673	2000834

H = YÜKSEKLİK = HEIGHT / W = GENİŞLİK = WIDTH / T = KALINLIK = THICKNESS

150 ATR 150-10

Yükseklik | Kanal Tipi | Genişlik | Kalınlık
Height | Type | Width | Thickness

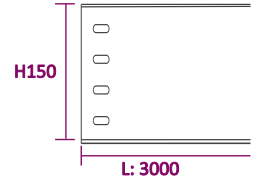
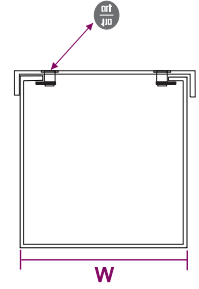

Standart uzunluk L:3000 mm
Toplu miktarlarda Özel ölçüler yapılabilir.
Standard Length L:3000 mm
Custom sizes can be made in bulk quantities.

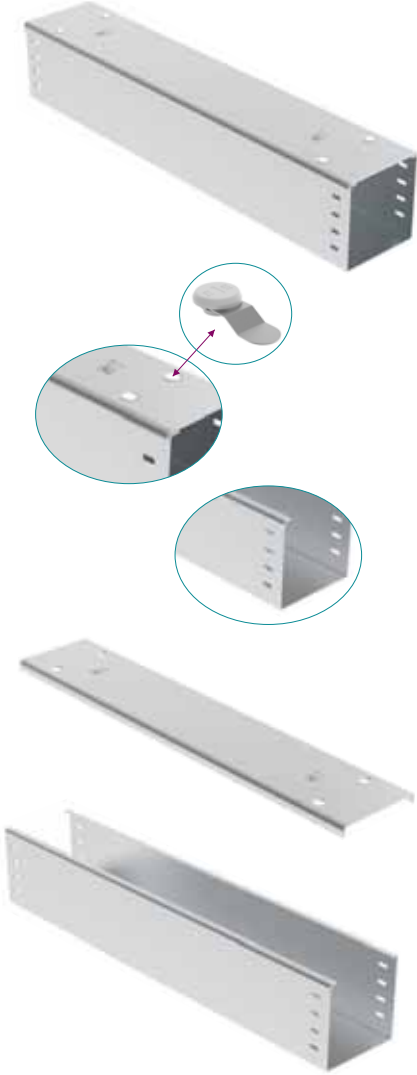

* Farklı kalınlık ve ölçülerde üretim yapılabılır.
* Malzeme ağırlıkları yaklaşık değerlerdir, ± %10 değişiklik gösterebilir.
* Malzeme kalınlık toleransı ± %10 dur.
* Lütfen siparişlerinizde sipariş kodu veya ürün kodu ve Kaplama şeklini belirtiniz.

* We can produce cable trays different thickness and dimensions
* Cable trays are shown approximately weight, they could change ± %10 difference.
* Cable trays thickness tolerances are shown ± %10 .
* Please indicate order code and coating type in your orders.

ATR SERIES

90° YATAY DÖNÜS

90° BEND

PREGALVANIZ (PG)
PREGALVANIZED (PG)
TS EN 10346



H50 = Tek delikli
H50 = One hole

H75 = İki delikli
H75 = Two holes

H100 = H150 = Dört delikli
H100 = H150 = Four holes



H50

Sipariş Kodu Order Code	W (mm)	T (mm)	Ağırlık (kg/ad) Weight (kg/pcs)	Barkod Kodu Barcode Code
50 ATR 050Y	50	1.20 mm	0,230	2006100
ATRK 050Y	50	1.20 mm	0,120	2006600
50 ATR 075Y	75	1.20 mm	0,396	2006101
ATRK 075Y	75	1.20 mm	0,190	2006601
50 ATR 100Y	100	1.20 mm	0,594	2006102
ATRK 100Y	100	1.20 mm	0,245	2006602
50 ATR 150Y	150	1.20 mm	0,785	2006103
ATRK 150Y	150	1.20 mm	0,455	2006603
50 ATR 200Y	200	1.20 mm	1,091	2006104
ATRK 200Y	200	1.20 mm	0,635	2006604

H75

Sipariş Kodu Order Code	W (mm)	T (mm)	Ağırlık (kg/ad) Weight (kg/pcs)	Barkod Kodu Barcode Code
75 ATR 075Y	75	1.20 mm	0,549	2006105
ATRK 075Y	75	1.20 mm	0,190	2006601
75 ATR 100Y	100	1.20 mm	0,747	2006106
ATRK 100Y	100	1.20 mm	0,245	2006602
75 ATR 150Y	150	1.20 mm	0,942	2006107
ATRK 150Y	150	1.20 mm	0,455	2006603
75 ATR 200Y	200	1.20 mm	1,258	2006108
ATRK 200Y	200	1.20 mm	0,635	2006604

H100

Sipariş Kodu Order Code	W (mm)	T (mm)	Ağırlık (kg/ad) Weight (kg/pcs)	Barkod Kodu Barcode Code
100 ATR 100Y	100	1.20 mm	0,810	2006109
ATRK 100Y	100	1.20 mm	0,245	2006602
100 ATR 150Y	150	1.20 mm	1,087	2006110
ATRK 150Y	150	1.20 mm	0,455	2006603
100 ATR 200Y	200	1.20 mm	1,458	2006111
ATRK 200Y	200	1.20 mm	0,635	2006604

H150

Sipariş Kodu Order Code	W (mm)	T (mm)	Ağırlık (kg/ad) Weight (kg/pcs)	Barkod Kodu Barcode Code
150 ATR 150Y	150	1.20 mm	1,884	2006112
ATRK 150Y	150	1.20 mm	0,455	2006603
150 ATR 200Y	200	1.20 mm	2,516	2006113
ATRK 200Y	200	1.20 mm	0,635	2006604

H = YÜKSEKLİK = HEIGHT / W = GENİŞLİK = WIDTH / T = KALINLIK = THICKNESS

H ATR 100 Y

Yükseklik Height	Kanal Tipi Type	Genişlik Width	Modül Module
---------------------	--------------------	-------------------	-----------------

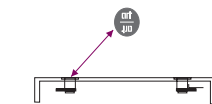
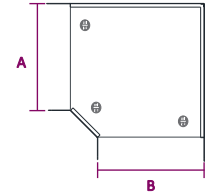
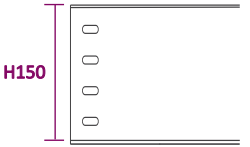
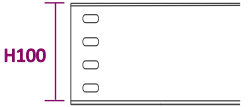
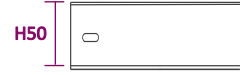

Dönüşlerde "A-B" ölçüleri esit olarak üretilmektedir. İsteğe bağlı olarak farklı ölçülerde üretim yapılır. Bends are produced same dimension for "A-B" as well as we can produce special dimensions regarding your inquiry.

ARTIM METAL ELEKTRİK A.Ş.

* Farklı kalınlık ve ölçülerde üretim yapılabılır.
* Malzeme ağırlıkları yaklaşık değerlerdir, ± %10 değişiklik gösterebilir.
* Malzeme kalınlık toleransı ± %10 dur.
* Lütfen siparişlerinizde sipariş kodu veya ürün kodu ve Kaplama şeklini belirtiniz.

* We can produce cable trays different thickness and dimensions
* Cable trays are shown approximately weight, they could change ± %10 difference.
* Cable trays thickness tolerances are shown ± %10 .
* Please indicate order code and coating type in your orders.

ATR SERIES

90° YATAY DÖNÜS

90° BEND

SICAK DALDIRMA (SD)

HOT DIP GALVANIZED (HDG)

TS EN ISO 1461



H50 = Tek delikli
H50 = One hole

H75 = İki delikli
H75 = Two holes

H100 = H150 = Dört delikli
H100 = H150 = Four holes



H50

Sipariş Kodu Order Code	W (mm)	T (mm)	Ağırlık (kg/ad) Weight (kg/pcs)	Barkod Kodu Barcode Code
50 ATR 050Y	50	1.50 mm	0,253	2006100
ATRK 050Y	50	1.50 mm	0,132	2006600
50 ATR 075Y	75	1.50 mm	0,436	2006101
ATRK 075Y	75	1.50 mm	0,209	2006601
50 ATR 100Y	100	1.50 mm	0,653	2006102
ATRK 100Y	100	1.50 mm	0,270	2006602
50 ATR 150Y	150	1.50 mm	0,864	2006103
ATRK 150Y	150	1.50 mm	0,501	2006603
50 ATR 200Y	200	1.50 mm	1,200	2006104
ATRK 200Y	200	1.50 mm	0,699	2006604

H75

Sipariş Kodu Order Code	W (mm)	T (mm)	Ağırlık (kg/ad) Weight (kg/pcs)	Barkod Kodu Barcode Code
75 ATR 075Y	75	1.50 mm	0,604	2006105
ATRK 075Y	75	1.50 mm	0,209	2006601
75 ATR 100Y	100	1.50 mm	0,822	2006106
ATRK 100Y	100	1.50 mm	0,270	2006602
75 ATR 150Y	150	1.50 mm	1,036	2006107
ATRK 150Y	150	1.50 mm	0,501	2006603
75 ATR 200Y	200	1.50 mm	1,384	2006108
ATRK 200Y	200	1.50 mm	0,699	2006604

H100

Sipariş Kodu Order Code	W (mm)	T (mm)	Ağırlık (kg/ad) Weight (kg/pcs)	Barkod Kodu Barcode Code
100 ATR 100Y	100	1.50 mm	0,891	2006109
ATRK 100Y	100	1.50 mm	0,270	2006602
100 ATR 150Y	150	1.50 mm	1,196	2006110
ATRK 150Y	150	1.50 mm	0,501	2006603
100 ATR 200Y	200	1.50 mm	1,604	2006111
ATRK 200Y	200	1.50 mm	0,699	2006604

H150

Sipariş Kodu Order Code	W (mm)	T (mm)	Ağırlık (kg/ad) Weight (kg/pcs)	Barkod Kodu Barcode Code
150 ATR 150Y	150	1.50 mm	2,072	2006112
ATRK 150Y	150	1.50 mm	0,501	2006603
150 ATR 200Y	200	1.50 mm	2,768	2006113
ATRK 200Y	200	1.50 mm	0,699	2006604

H = YÜKSEKLİK = HEIGHT / W = GENİŞLİK = WIDTH / T = KALINLIK = THICKNESS

H ATR 100 Y

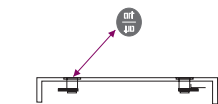
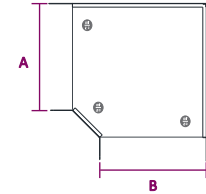
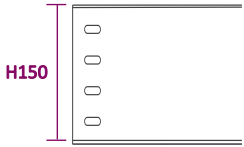
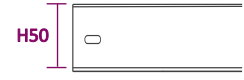

Dönüşlerde "A-B" ölçüleri esit olarak üretilmektedir. İsteğe bağlı olarak farklı ölçülerde üretim yapılır. Bends are produced same dimension for "A-B" as well as we can produce special dimensions regarding your inquiry.

* Farklı kalınlık ve ölçülerde üretim yapılabılır.
* Malzeme ağırlıkları yaklaşık değerlerdir, ± %10 değişiklik gösterebilir.
* Malzeme kalınlık toleransı ± %10 dur.
* Lütfen siparişlerinizde sipariş kodu veya ürün kodu ve Kaplama şeklini belirtiniz.

* We can produce cable trays different thickness and dimensions
* Cable trays are shown approximately weight, they could change ± %10 difference.
* Cable trays thickness tolerances are shown ± %10 .
* Please indicate order code and coating type in your orders.

ATR SERIES

T BAGLANTI

T BEND

PREGALVANIZ (PG)
PREGALVANIZED (PG)
TS EN 10346



H50 = Tek delikli
H50 = One hole

H75 = İki delikli
H75 = Two holes

H100 = H150 = Dört delikli
H100 = H150 = Four holes



H50

Sipariş Kodu Order Code	W (mm)	T (mm)	Ağırlık (kg/ad) Weight (kg/pcs)	Barkod Kodu Barcode Code
50 ATR 050T	50	1.20 mm	0,302	2006200
ATRK 050T	50	1.20 mm	0,140	2006700
50 ATR 075T	75	1.20 mm	0,453	2006201
ATRK 075T	75	1.20 mm	0,210	2006701
50 ATR 100T	100	1.20 mm	0,716	2006202
ATRK 100T	100	1.20 mm	0,290	2006702
50 ATR 150T	150	1.20 mm	0,893	2006203
ATRK 150T	150	1.20 mm	0,530	2006703
50 ATR 200T	200	1.20 mm	1,202	2006204
ATRK 200T	200	1.20 mm	0,775	2006704

H75

Sipariş Kodu Order Code	W (mm)	T (mm)	Ağırlık (kg/ad) Weight (kg/pcs)	Barkod Kodu Barcode Code
75 ATR 075T	75	1.20 mm	0,667	2006205
ATRK 075T	75	1.20 mm	0,210	2006701
75 ATR 100T	100	1.20 mm	0,889	2006206
ATRK 100T	100	1.20 mm	0,290	2006702
75 ATR 150T	150	1.20 mm	1,065	2006207
ATRK 150T	150	1.20 mm	0,530	2006703
75 ATR 200T	200	1.20 mm	1,382	2006208
ATRK 200T	200	1.20 mm	0,775	2006704

H100

Sipariş Kodu Order Code	W (mm)	T (mm)	Ağırlık (kg/ad) Weight (kg/pcs)	Barkod Kodu Barcode Code
100 ATR 100T	100	1.20 mm	1,026	2006209
ATRK 100T	100	1.20 mm	0,290	2006702
100 ATR 150T	150	1.20 mm	1,202	2006210
ATRK 150T	150	1.20 mm	0,530	2006703
100 ATR 200T	200	1.20 mm	1,559	2006211
ATRK 200T	200	1.20 mm	0,775	2006704

H150

Sipariş Kodu Order Code	W (mm)	T (mm)	Ağırlık (kg/ad) Weight (kg/pcs)	Barkod Kodu Barcode Code
150 ATR 150T	150	1.20 mm	1,803	2006212
ATRK 150T	150	1.20 mm	0,530	2006703
150 ATR 200T	200	1.20 mm	2,338	2006213
ATRK 200T	200	1.20 mm	0,775	2006704

H = YÜKSEKLİK = HEIGHT / W = GENİŞLİK = WIDTH / T = KALINLIK = THICKNESS

H ATR 100 T

Yükseklik Kanal Tipi Genişlik Modül
Height Type Width Module

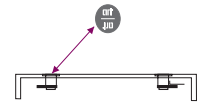
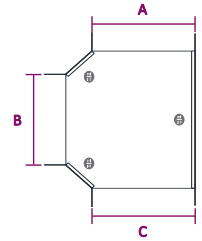
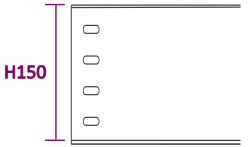
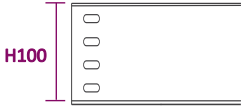
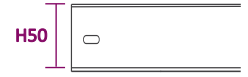

Dönüşlerde "A-B-C" ölçüleri esit olarak üretilmektedir. İsteğe bağlı olarak farklı ölçülerde üretim yapılır. Bends are produced same dimension for "A-B-C" as well as we can produce special dimensions regarding your inquiry.

ARTIM METAL ELEKTRİK A.Ş.

* Farklı kalınlık ve ölçülerde üretim yapılabılır.
* Malzeme ağırlıkları yaklaşık değerlerdir, ± %10 değişiklik gösterebilir.
* Malzeme kalınlık toleransı ± %10 dur.
* Lütfen siparişlerinizde sipariş kodu veya ürün kodu ve Kaplama şeklini belirtiniz.

* We can produce cable trays different thickness and dimensions
* Cable trays are shown approximately weight, they could change ± %10 difference.
* Cable trays thickness tolerances are shown ± %10 .
* Please indicate order code and coating type in your orders.

ATR SERIES

T BAGLANTI

T BEND

SICAK DALDIRMA (SD)

HOT DIP GALVANIZED (HDG)

TS EN ISO 1461



H50 = Tek delikli
H50 = One hole

H75 = İki delikli
H75 = Two holes

H100 = H150 = Dört delikli
H100 = H150 = Four holes



H50

Sipariş Kodu Order Code	W (mm)	T (mm)	Ağırlık (kg/ad) Weight (kg/pcs)	Barkod Kodu Barcode Code
50 ATR 050T	50	1.50 mm	0,332	2006200
ATRK 050T	50	1.50 mm	0,154	2006700
50 ATR 075T	75	1.50 mm	0,498	2006201
ATRK 075T	75	1.50 mm	0,231	2006701
50 ATR 100T	100	1.50 mm	0,788	2006202
ATRK 100T	100	1.50 mm	0,319	2006702
50 ATR 150T	150	1.50 mm	0,982	2006203
ATRK 150T	150	1.50 mm	0,583	2006703
50 ATR 200T	200	1.50 mm	1,322	2006204
ATRK 200T	200	1.50 mm	0,853	2006704

H75

Sipariş Kodu Order Code	W (mm)	T (mm)	Ağırlık (kg/ad) Weight (kg/pcs)	Barkod Kodu Barcode Code
75 ATR 075T	75	1.50 mm	0,734	2006205
ATRK 075T	75	1.50 mm	0,231	2006701
75 ATR 100T	100	1.50 mm	0,978	2006206
ATRK 100T	100	1.50 mm	0,319	2006702
75 ATR 150T	150	1.50 mm	1,172	2006207
ATRK 150T	150	1.50 mm	0,583	2006703
75 ATR 200T	200	1.50 mm	1,520	2006208
ATRK 200T	200	1.50 mm	0,853	2006704

H100

Sipariş Kodu Order Code	W (mm)	T (mm)	Ağırlık (kg/ad) Weight (kg/pcs)	Barkod Kodu Barcode Code
100 ATR 100T	100	1.50 mm	1,129	2006209
ATRK 100T	100	1.50 mm	0,319	2006702
100 ATR 150T	150	1.50 mm	1,322	2006210
ATRK 150T	150	1.50 mm	0,583	2006703
100 ATR 200T	200	1.50 mm	1,715	2006211
ATRK 200T	200	1.50 mm	0,853	2006704

H150

Sipariş Kodu Order Code	W (mm)	T (mm)	Ağırlık (kg/ad) Weight (kg/pcs)	Barkod Kodu Barcode Code
150 ATR 150T	150	1.50 mm	1,983	2006212
ATRK 150T	150	1.50 mm	0,583	2006703
150 ATR 200T	200	1.50 mm	2,572	2006213
ATRK 200T	200	1.50 mm	0,853	2006704

H = YÜKSEKLİK = HEIGHT / W = GENİŞLİK = WIDTH / T = KALINLIK = THICKNESS

H ATR 100 T

Yükseklik Kanal Tipi Genişlik Modül
Height Type Width Module

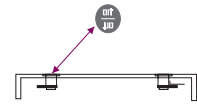
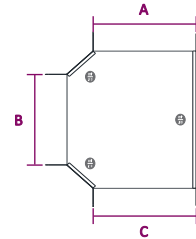
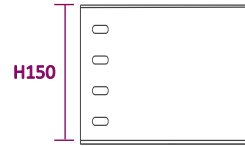
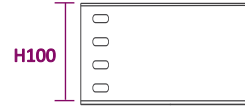
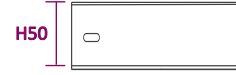

Dönüşlerde "A-B-C" ölçüleri eşit olarak üretilmektedir. İsteğe bağlı olarak farklı ölçülerde üretim yapılır. Bends are produced same dimension for "A-B-C" as well as we can produce special dimensions regarding your inquiry.

* Farklı kalınlık ve ölçülerde üretim yapılabılır.
* Malzeme ağırlıkları yaklaşık değerlerdir, ± %10 değişiklik gösterebilir.
* Malzeme kalınlık toleransı ± %10 dur.
* Lütfen siparişlerinizde sipariş kodu veya ürün kodu ve Kaplama şeklini belirtiniz.

* We can produce cable trays different thickness and dimensions
* Cable trays are shown approximately weight, they could change ± %10 difference.
* Cable trays thickness tolerances are shown ± %10 .
* Please indicate order code and coating type in your orders.

ATR SERIES

DÖRTLÜ BAGLANTI

FOUR WAY CROSSING

PREGALVANIZ (PG)
PREGALVANIZED (PG)
TS EN 10346



H50 = Tek delikli
H50 = One hole

H75 = İki delikli
H75 = Two holes

H100 = H150 = Dört delikli
H100 = H150 = Four holes



H50

Sipariş Kodu Order Code	W (mm)	T (mm)	Ağırlık (kg/ad) Weight (kg/pcs)	Barkod Kodu Barcode Code
50 ATR 050D	50	1.20 mm	0,342	2006300
ATRK 050D	50	1.20 mm	0,170	2006800
50 ATR 075D	75	1.20 mm	0,513	2006301
ATRK 075D	75	1.20 mm	0,255	2006801
50 ATR 100D	100	1.20 mm	0,828	2006302
ATRK 100D	100	1.20 mm	0,340	2006802
50 ATR 150D	150	1.20 mm	0,909	2006303
ATRK 150D	150	1.20 mm	0,595	2006803
50 ATR 200D	200	1.20 mm	1,303	2006304
ATRK 200D	200	1.20 mm	0,805	2006804

H75

Sipariş Kodu Order Code	W (mm)	T (mm)	Ağırlık (kg/ad) Weight (kg/pcs)	Barkod Kodu Barcode Code
75 ATR 075D	75	1.20 mm	0,756	2006305
ATRK 075D	75	1.20 mm	0,255	2006801
75 ATR 100D	100	1.20 mm	1,008	2006306
ATRK 100D	100	1.20 mm	0,340	2006802
75 ATR 150D	150	1.20 mm	1,166	2006307
ATRK 150D	150	1.20 mm	0,595	2006803
75 ATR 200D	200	1.20 mm	1,487	2006308
ATRK 200D	200	1.20 mm	0,805	2006804

H100

Sipariş Kodu Order Code	W (mm)	T (mm)	Ağırlık (kg/ad) Weight (kg/pcs)	Barkod Kodu Barcode Code
100 ATR 100D	100	1.20 mm	1,163	2006309
ATRK 100D	100	1.20 mm	0,340	2006802
100 ATR 150D	150	1.20 mm	1,296	2006310
ATRK 150D	150	1.20 mm	0,595	2006803
100 ATR 200D	200	1.20 mm	1,634	2006311
ATRK 200D	200	1.20 mm	0,805	2006804

H150

Sipariş Kodu Order Code	W (mm)	T (mm)	Ağırlık (kg/ad) Weight (kg/pcs)	Barkod Kodu Barcode Code
150 ATR 150D	150	1.20 mm	1,944	2006312
ATRK 150D	150	1.20 mm	0,595	2006803
150 ATR 200D	200	1.20 mm	2,451	2006313
ATRK 200D	200	1.20 mm	0,805	2006804

H = YÜKSEKLİK = HEIGHT / W = GENİŞLİK = WIDTH / T = KALINLIK = THICKNESS

H ATR 100 D

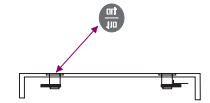
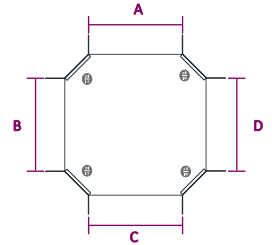
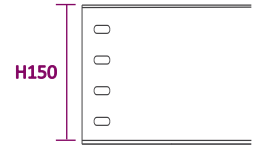
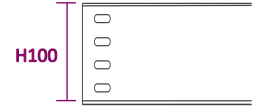
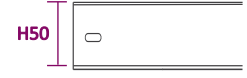

Dönüşlerde "A-B-C-D" ölçüleri esit olarak üretilmektedir. İsteğe bağlı olarak farklı ölçülerde üretim yapılır. Bends are produced same dimension for "A-B-C-D" as well as we can produce special dimensions regarding your inquiry.

ARTIM METAL ELEKTRİK A.Ş.

* Farklı kalınlık ve ölçülerde üretim yapılabılır.
* Malzeme ağırlıkları yaklaşık değerlerdir, \pm %10 değişiklik gösterebilir.
* Malzeme kalınlık toleransı \pm %10 dur.
* Lütfen siparişlerinizde sipariş kodu veya ürün kodu ve Kaplama şeklini belirtiniz.

* We can produce cable trays different thickness and dimensions
* Cable trays are shown approximately weight, they could change \pm %10 difference.
* Cable trays thickness tolerances are shown \pm %10 .
* Please indicate order code and coating type in your orders.

ATR SERIES

DÖRTLÜ BAGLANTI

FOUR WAY CROSSING

SICAK DALDIRMA (SD)

HOT DIP GALVANIZED (HDG)

TS EN ISO 1461



H50 = Tek delikli

H50 = One hole

H75 = İki delikli

H75 = Two holes

H100 = H150 = Dört delikli

H100 = H150 = Four holes



H50

Sipariş Kodu Order Code	W (mm)	T (mm)	Ağırlık (kg/ad) Weight (kg/pcs)	Barkod Kodu Barcode Code
50 ATR 050D	50	1.50 mm	0,376	2006300
ATRK 050D	50	1.50 mm	0,187	2006800
50 ATR 075D	75	1.50 mm	0,564	2006301
ATRK 075D	75	1.50 mm	0,281	2006801
50 ATR 100D	100	1.50 mm	0,911	2006302
ATRK 100D	100	1.50 mm	0,374	2006802
50 ATR 150D	150	1.50 mm	1,000	2006303
ATRK 150D	150	1.50 mm	0,655	2006803
50 ATR 200D	200	1.50 mm	1,433	2006304
ATRK 200D	200	1.50 mm	0,886	2006804

H75

Sipariş Kodu Order Code	W (mm)	T (mm)	Ağırlık (kg/ad) Weight (kg/pcs)	Barkod Kodu Barcode Code
75 ATR 075D	75	1.50 mm	0,832	2006305
ATRK 075D	75	1.50 mm	0,281	2006801
75 ATR 100D	100	1.50 mm	1,109	2006306
ATRK 100D	100	1.50 mm	0,374	2006802
75 ATR 150D	150	1.50 mm	1,283	2006307
ATRK 150D	150	1.50 mm	0,655	2006803
75 ATR 200D	200	1.50 mm	1,636	2006308
ATRK 200D	200	1.50 mm	0,886	2006804

H100

Sipariş Kodu Order Code	W (mm)	T (mm)	Ağırlık (kg/ad) Weight (kg/pcs)	Barkod Kodu Barcode Code
100 ATR 100D	100	1.50 mm	1,279	2006309
ATRK 100D	100	1.50 mm	0,374	2006802
100 ATR 150D	150	1.50 mm	1,426	2006310
ATRK 150D	150	1.50 mm	0,655	2006803
100 ATR 200D	200	1.50 mm	1,797	2006311
ATRK 200D	200	1.50 mm	0,886	2006804

H150

Sipariş Kodu Order Code	W (mm)	T (mm)	Ağırlık (kg/ad) Weight (kg/pcs)	Barkod Kodu Barcode Code
150 ATR 150D	150	1.50 mm	2,138	2006312
ATRK 150D	150	1.50 mm	0,655	2006803
150 ATR 200D	200	1.50 mm	2,696	2006313
ATRK 200D	200	1.50 mm	0,886	2006804

H = YÜKSEKLİK = HEIGHT / W = GENİŞLİK = WIDTH / T = KALINLIK = THICKNESS

H ATR 100 D

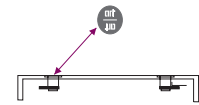
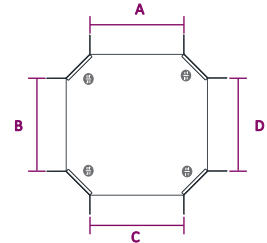
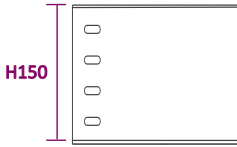
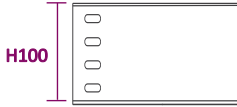
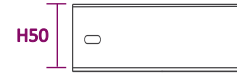

Dönüşlerde "A-B-C-D" ölçüleri esit olarak üretilmektedir. İsteğe bağlı olarak farklı ölçülerde üretim yapılır. Bends are produced same dimension for "A-B-C-D" as well as we can produce special dimensions regarding your inquiry.

* Farklı kalınlık ve ölçülerde üretim yapıla bilinir.
* Malzeme ağırlıkları yaklaşık değerlerdir, ± %10 değişiklik gösterebilir.
* Malzeme kalınlık toleransı ± %10 dur.
* Lütfen siparişlerinizde sipariş kodu veya ürün kodu ve Kaplama şeklini belirtiniz.

* We can produce cable trays different thickness and dimensions
* Cable trays are shown approximately weight, they could change ± %10 difference.
* Cable trays thickness tolerances are shown ± %10 .
* Please indicate order code and coating type in your orders.

ATR SERIES

REDÜKSİYON

REDUCING ANGLES

PREGALVANIZ (PG)
PREGALVANIZED (PG)
TS EN 10346



H50 = Tek delikli
H50 = One hole
H75 = İki delikli
H75 = Two holes

H100 = H150 = Dört delikli
H100 = H150 = Four holes

H50 x H50

Sipariş Kodu Order Code	W (mm)	T (mm)	Ağırlık (kg/ad) Weight (kg/pcs)	Barkod Kodu Barcode Code
ATR R1	50x75	1.20 mm	0,717	2006500

H50 x H75

Sipariş Kodu Order Code	W (mm)	T (mm)	Ağırlık (kg/ad) Weight (kg/pcs)	Barkod Kodu Barcode Code
ATR R2	75x75	1.20 mm	0,865	2006501
ATR R3	75x100	1.20 mm	0,925	2006502

H75 x H75

Sipariş Kodu Order Code	W (mm)	T (mm)	Ağırlık (kg/ad) Weight (kg/pcs)	Barkod Kodu Barcode Code
ATR R4	75x100	1.20 mm	0,987	2006503

H75 x H100

Sipariş Kodu Order Code	W (mm)	T (mm)	Ağırlık (kg/ad) Weight (kg/pcs)	Barkod Kodu Barcode Code
ATR R5	75x100	1.20 mm	1,148	2006504
ATR R6	100x100	1.20 mm	1,252	2006505
ATR R7	100x150	1.20 mm	1,257	2006506

H100 x H100

Sipariş Kodu Order Code	W (mm)	T (mm)	Ağırlık (kg/ad) Weight (kg/pcs)	Barkod Kodu Barcode Code
ATR R8	100x150	1.20 mm	1,395	2006507
ATR R9	100x200	1.20 mm	1,432	2006508
ATR R10	150x200	1.20 mm	1,631	2006509

H100 x H150

Sipariş Kodu Order Code	W (mm)	T (mm)	Ağırlık (kg/ad) Weight (kg/pcs)	Barkod Kodu Barcode Code
ATR R11	150x150	1.20 mm	1,486	2006510
ATR R12	150x200	1.20 mm	1,757	2006511

H150 x H150

Sipariş Kodu Order Code	W (mm)	T (mm)	Ağırlık (kg/ad) Weight (kg/pcs)	Barkod Kodu Barcode Code
ATR R13	150x200	1.20 mm	1,839	2006512

H = YÜKSEKLİK = HEIGHT / W = GENİŞLİK = WIDTH / T = KALINLIK = THICKNESS

1.20 mm

Sipariş Kodu Order Code	W (mm)	T (mm)	Ağırlık (kg/ad) Weight (kg/pcs)	Barkod Kodu Barcode Code
ATR R1 - K	50x75	1.20 mm	0,188	2006551
ATR R2 - K	75x75	1.20 mm	0,198	2006552
ATR R3 - K	75x100	1.20 mm	0,226	2006553
ATR R6 - K	100x100	1.20 mm	0,230	2006554
ATR R7 - K	100x150	1.20 mm	0,282	2006555
ATR R10 - K	100x200	1.20 mm	0,414	2006556
ATR R11 - K	150x200	1.20 mm	0,424	2006557

H = YÜKSEKLİK = HEIGHT / W = GENİŞLİK = WIDTH / T = KALINLIK = THICKNESS

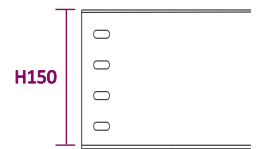
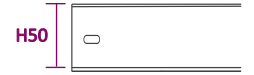
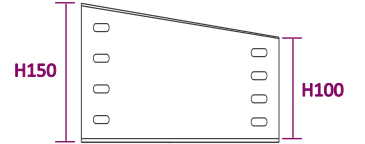
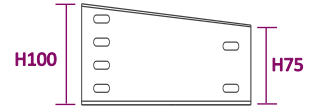
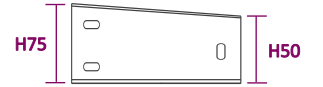
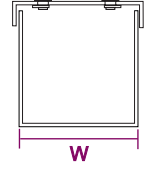
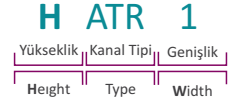

ARTIM METAL ELEKTRİK A.Ş.

* Farklı kalınlık ve ölçülerde üretim yapılabılır.
* Malzeme ağırlıkları yaklaşık değerlerdir, \pm %10 değişiklik gösterebilir.
* Malzeme kalınlık toleransı \pm %10 dur.
* Lütfen siparişlerinizde sipariş kodu veya ürün kodu ve Kaplama şeklini belirtiniz.

* We can produce cable trays different thickness and dimensions
* Cable trays are shown approximately weight, they could change \pm %10 difference.
* Cable trays thickness tolerances are shown \pm %10 .
* Please indicate order code and coating type in your orders.

ATR SERIES

REDÜKSİYON

REDUCING ANGLES

SICAK DALDIRMA (SD)

HOT DIP GALVANIZED (HDG)

TS EN ISO 1461



H50 = Tek delikli
H50 = One hole

H75 = İki delikli
H75 = Two holes

H100 = H150 = Dört delikli
H100 = H150 = Four holes



H50 x H50

Sipariş Kodu Order Code	W (mm)	T (mm)	Ağırlık (kg/ad) Weight (kg/pcs)	Barkod Kodu Barcode Code
ATR R1	50x75	1.20 mm	0,789	2006500

H50 x H75

Sipariş Kodu Order Code	W (mm)	T (mm)	Ağırlık (kg/ad) Weight (kg/pcs)	Barkod Kodu Barcode Code
ATR R2	75x75	1.20 mm	0,952	2006501
ATR R3	75x100	1.20 mm	1,018	2006502

H75 x H75

Sipariş Kodu Order Code	W (mm)	T (mm)	Ağırlık (kg/ad) Weight (kg/pcs)	Barkod Kodu Barcode Code
ATR R4	75x100	1.20 mm	1,086	2006503

H75 x H100

Sipariş Kodu Order Code	W (mm)	T (mm)	Ağırlık (kg/ad) Weight (kg/pcs)	Barkod Kodu Barcode Code
ATR R5	75x100	1.20 mm	1,263	2006504
ATR R6	100x100	1.20 mm	1,377	2006505
ATR R7	100x150	1.20 mm	1,383	2006506

H100 x H100

Sipariş Kodu Order Code	W (mm)	T (mm)	Ağırlık (kg/ad) Weight (kg/pcs)	Barkod Kodu Barcode Code
ATR R8	100x150	1.20 mm	1,535	2006507
ATR R9	100x200	1.20 mm	1,575	2006508
ATR R10	150x200	1.20 mm	1,794	2006509

H100 x H150

Sipariş Kodu Order Code	W (mm)	T (mm)	Ağırlık (kg/ad) Weight (kg/pcs)	Barkod Kodu Barcode Code
ATR R11	150x150	1.20 mm	1,635	2006510
ATR R12	150x200	1.20 mm	1,933	2006511

H150 x H150

Sipariş Kodu Order Code	W (mm)	T (mm)	Ağırlık (kg/ad) Weight (kg/pcs)	Barkod Kodu Barcode Code
ATR R13	150x200	1.20 mm	2,023	2006512

H = YÜKSEKLİK = HEIGHT / W = GENİŞLİK = WIDTH / T = KALINLIK = THICKNESS

1.20 mm

Sipariş Kodu Order Code	W (mm)	T (mm)	Ağırlık (kg/ad) Weight (kg/pcs)	Barkod Kodu Barcode Code
ATR R1 - K	50x75	1.20 mm	0,207	2006551
ATR R2 - K	75x75	1.20 mm	0,218	2006552
ATR R3 - K	75x100	1.20 mm	0,249	2006553
ATR R6 - K	100x100	1.20 mm	0,253	2006554
ATR R7 - K	100x150	1.20 mm	0,310	2006555
ATR R10 - K	100x200	1.20 mm	0,455	2006556
ATR R11 - K	150x200	1.20 mm	0,466	2006557

H = YÜKSEKLİK = HEIGHT / W = GENİŞLİK = WIDTH / T = KALINLIK = THICKNESS

H ATR 1

Yükseklik | Kanal Tipi | Genişlik
Height | Type | Width

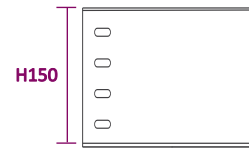
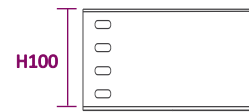
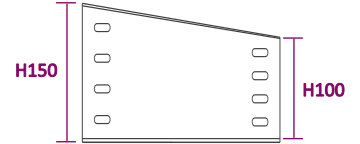
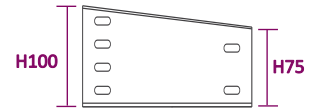
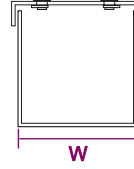

* Farklı kalınlık ve ölçülerde üretim yapılabılır.
* Malzeme ağırlıkları yaklaşık değerlerdir, \pm %10 değişiklik gösterebilir.
* Malzeme kalınlık toleransı \pm %10 dur.
* Lütfen siparişlerinizde sipariş kodu veya ürün kodu ve Kaplama şeklini belirtiniz.

* We can produce cable trays different thickness and dimensions
* Cable trays are shown approximately weight, they could change \pm %10 difference.
* Cable trays thickness tolerances are shown \pm %10 .
* Please indicate order code and coating type in your orders.

ATR SERIES

İÇ BÜKEY DÖNÜS (SABIT)

CONSTANT INSIDE VERTICAL BENDS

PREGALVANIZ (PG)
PREGALVANIZED (PG)
TS EN 10346



H50 = Tek delikli
H50 = One hole

H75 = İki delikli
H75 = Two holes

H100 = H150 = Dört delikli
H100 = H150 = Four holes

H50

Sipariş Kodu Order Code	W (mm)	T (mm)	Ağırlık (kg/ad) Weight (kg/pcs)	Barkod Kodu Barcode Code
50 ATR 050B S1	50	1.20 mm	1,235	2006400
ATRK 050B S1	50	1.20 mm	0,440	2006900
50 ATR 075B S1	75	1.20 mm	1,852	2006401
ATRK 075B S1	75	1.20 mm	0,660	2006901
50 ATR 100B S1	100	1.20 mm	1,575	2006402
ATRK 100B S1	100	1.20 mm	0,755	2006902
50 ATR 150B S1	150	1.20 mm	1,975	2006403
ATRK 150B S1	150	1.20 mm	1,130	2006903
50 ATR 200B S1	200	1.20 mm	2,265	2006404
ATRK 200B S1	200	1.20 mm	1,385	2006904

H75

Sipariş Kodu Order Code	W (mm)	T (mm)	Ağırlık (kg/ad) Weight (kg/pcs)	Barkod Kodu Barcode Code
75 ATR 07B S1	75	1.20 mm	1,388	2006405
ATRK 075B S1	75	1.20 mm	0,660	2006901
75 ATR 100B S1	100	1.20 mm	1,850	2006406
ATRK 100B S1	100	1.20 mm	0,755	2006902
75 ATR 150B S1	150	1.20 mm	2,250	2006407
ATRK 150B S1	150	1.20 mm	1,130	2006903
75 ATR 200B S1	200	1.20 mm	2,535	2006408
ATRK 200B S1	200	1.20 mm	1,385	2006904

H100

Sipariş Kodu Order Code	W (mm)	T (mm)	Ağırlık (kg/ad) Weight (kg/pcs)	Barkod Kodu Barcode Code
100 ATR 100B S1	100	1.20 mm	2,050	2006409
ATRK 100B S1	100	1.20 mm	0,755	2006902
100 ATR 150B S1	150	1.20 mm	2,455	2006410
ATRK 150B S1	150	1.20 mm	1,130	2006903
100 ATR 200B S1	200	1.20 mm	2,745	2006411
ATRK 200B S1	200	1.20 mm	1,385	2006904

H150

Sipariş Kodu Order Code	W (mm)	T (mm)	Ağırlık (kg/ad) Weight (kg/pcs)	Barkod Kodu Barcode Code
150 ATR 150B S1	150	1.20 mm	3,682	2006412
ATRK 150B S1	150	1.20 mm	1,130	2006903
150 ATR 200B S1	200	1.20 mm	4,117	2006413
ATRK 200B S1	200	1.20 mm	1,385	2006904

H = YÜKSEKLİK = HEIGHT / W = GENİŞLİK = WIDTH / T = KALINLIK = THICKNESS

H ATR 100 B S1

Yükseklik Kanal Tipi Genişlik Modül
Height Type Width Module

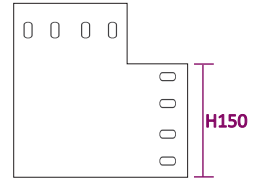
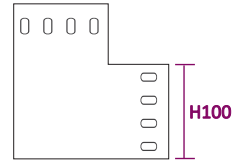
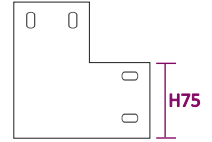
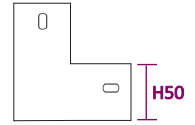
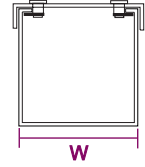

ARTIM METAL ELEKTRİK A.Ş.

* Farklı kalınlık ve ölçülerde üretim yapılabılır.
* Malzeme ağırlıkları yaklaşık değerlerdir, ± %10 değişiklik gösterebilir.
* Malzeme kalınlık toleransı ± %10 dur.
* Lütfen siparişlerinizde sipariş kodu veya ürün kodu ve Kaplama şeklini belirtiniz.

* We can produce cable trays different thickness and dimensions
* Cable trays are shown approximately weight, they could change ± %10 difference.
* Cable trays thickness tolerances are shown ± %10 .
* Please indicate order code and coating type in your orders.

ATR SERIES

İÇ BÜKEY DÖNÜS (SABIT)

CONSTANT INSIDE VERTICAL BENS

SICAK DALDIRMA (SD)

HOT DIP GALVANIZED (HDG)

TS EN ISO 1461



H50 = Tek delikli
H50 = One hole

H75 = İki delikli
H75 = Two holes

H100 = H150 = Dört delikli
H100 = H150 = Four holes

H50

Sipariş Kodu Order Code	W (mm)	T (mm)	Ağırlık (kg/ad) Weight (kg/pcs)	Barkod Kodu Barcode Code
50 ATR 050B S1	50	1.50 mm	1,359	2006400
ATRK 050B S1	50	1.50 mm	0,484	2006900
50 ATR 075B S1	75	1.50 mm	2,037	2006401
ATRK 075B S1	75	1.50 mm	0,726	2006901
50 ATR 100B S1	100	1.50 mm	1,733	2006402
ATRK 100B S1	100	1.50 mm	0,831	2006902
50 ATR 150B S1	150	1.50 mm	2,173	2006403
ATRK 150B S1	150	1.50 mm	1,243	2006903
50 ATR 200B S1	200	1.50 mm	2,492	2006404
ATRK 200B S1	200	1.50 mm	1,524	2006904

H75

Sipariş Kodu Order Code	W (mm)	T (mm)	Ağırlık (kg/ad) Weight (kg/pcs)	Barkod Kodu Barcode Code
75 ATR 07B S1	75	1.50 mm	1,527	2006405
ATRK 075B S1	75	1.50 mm	0,726	2006901
75 ATR 100B S1	100	1.50 mm	2,035	2006406
ATRK 100B S1	100	1.50 mm	0,831	2006902
75 ATR 150B S1	150	1.50 mm	2,475	2006407
ATRK 150B S1	150	1.50 mm	1,243	2006903
75 ATR 200B S1	200	1.50 mm	2,789	2006408
ATRK 200B S1	200	1.50 mm	1,524	2006904

H100

Sipariş Kodu Order Code	W (mm)	T (mm)	Ağırlık (kg/ad) Weight (kg/pcs)	Barkod Kodu Barcode Code
100 ATR 100B S1	100	1.50 mm	2,255	2006409
ATRK 100B S1	100	1.50 mm	0,831	2006902
100 ATR 150B S1	150	1.50 mm	2,701	2006410
ATRK 150B S1	150	1.50 mm	1,243	2006903
100 ATR 200B S1	200	1.50 mm	3,020	2006411
ATRK 200B S1	200	1.50 mm	1,524	2006904

H150

Sipariş Kodu Order Code	W (mm)	T (mm)	Ağırlık (kg/ad) Weight (kg/pcs)	Barkod Kodu Barcode Code
150 ATR 150B S1	150	1.50 mm	4,050	2006412
ATRK 150B S1	150	1.50 mm	1,243	2006903
150 ATR 200B S1	200	1.50 mm	4,529	2006413
ATRK 200B S1	200	1.50 mm	1,524	2006904

H = YÜKSEKLİK = HEIGHT / W = GENİŞLİK = WIDTH / T = KALINLIK = THICKNESS

H ATR 100 B S1

Yükseklik Kanal Tipi Genişlik Modül
Height Type Width Module

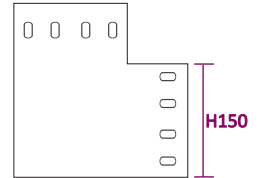
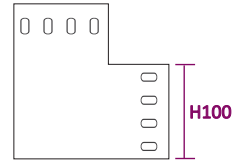
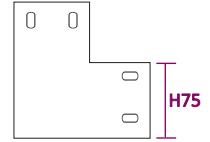
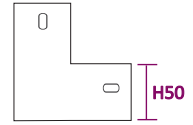
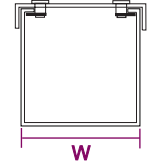

* Farklı kalınlık ve ölçülerde üretim yapıla bilinir.
* Malzeme ağırlıkları yaklaşık değerlerdir, ± %10 değişiklik gösterebilir.
* Malzeme kalınlık toleransı ± %10 dur.
* Lütfen siparişlerinizde sipariş kodu veya ürün kodu ve Kaplama şeklini belirtiniz.

* We can produce cable trays different thickness and dimensions
* Cable trays are shown approximately weight, they could change ± %10 difference.
* Cable trays thickness tolerances are shown ± %10 .
* Please indicate order code and coating type in your orders.

ATR SERIES

DIS BÜKEY DÖNÜS (SABIT)

CONSTANT OUTSIDE VERTICAL BENDS

PREGALVANIZ (PG)
PREGALVANIZED (PG)
TS EN 10346



H50 = Tek delikli
H50 = One hole

H75 = İki delikli
H75 = Two holes

H100 = H150 = Dört delikli
H100 = H150 = Four holes

H50

Sipariş Kodu Order Code	W (mm)	T (mm)	Ağırlık (kg/ad) Weight (kg/pcs)	Barkod Kodu Barcode Code
50 ATR 050B S2	50	1.20 mm	1,235	2006450
ATRK 050B S2	50	1.20 mm	0,440	2006950
50 ATR 075B S2	75	1.20 mm	1,852	2006451
ATRK 075B S2	75	1.20 mm	0,660	2006951
50 ATR 100B S2	100	1.20 mm	1,575	2006452
ATRK 100B S2	100	1.20 mm	0,755	2006952
50 ATR 150B S2	150	1.20 mm	1,975	2006453
ATRK 150B S2	150	1.20 mm	1,130	2006953
50 ATR 200B S2	200	1.20 mm	2,265	2006454
ATRK 200B S2	200	1.20 mm	1,385	2006954

H75

Sipariş Kodu Order Code	W (mm)	T (mm)	Ağırlık (kg/ad) Weight (kg/pcs)	Barkod Kodu Barcode Code
75 ATR 07B S2	75	1.20 mm	1,388	2006455
ATRK 075B S2	75	1.20 mm	0,660	2006951
75 ATR 100B S2	100	1.20 mm	1,850	2006456
ATRK 100B S2	100	1.20 mm	0,755	2006952
75 ATR 150B S2	150	1.20 mm	2,250	2006457
ATRK 150B S2	150	1.20 mm	1,130	2006953
75 ATR 200B S2	200	1.20 mm	2,535	2006458
ATRK 200B S2	200	1.20 mm	1,385	2006954

H100

Sipariş Kodu Order Code	W (mm)	T (mm)	Ağırlık (kg/ad) Weight (kg/pcs)	Barkod Kodu Barcode Code
100 ATR 100B S2	100	1.20 mm	2,050	2006459
ATRK 100B S2	100	1.20 mm	0,755	2006952
100 ATR 150B S2	150	1.20 mm	2,455	2006460
ATRK 150B S2	150	1.20 mm	1,130	2006953
100 ATR 200B S2	200	1.20 mm	2,745	2006461
ATRK 200B S2	200	1.20 mm	1,385	2006954

H150

Sipariş Kodu Order Code	W (mm)	T (mm)	Ağırlık (kg/ad) Weight (kg/pcs)	Barkod Kodu Barcode Code
150 ATR 150B S2	150	1.20 mm	3,682	2006462
ATRK 150B S2	150	1.20 mm	1,130	2006953
150 ATR 200B S2	200	1.20 mm	4,117	2006463
ATRK 200B S2	200	1.20 mm	1,385	2006954

H = YÜKSEKLİK = HEIGHT / W = GENİŞLİK = WIDTH / T = KALINLIK = THICKNESS

H ATR 100 B S2

Yükseklik Kanal Tipi Genişlik Modül
Height Type Width Module

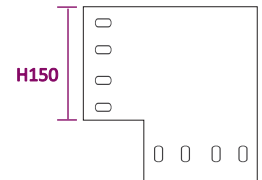
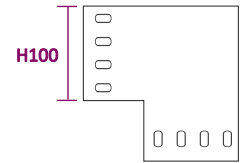
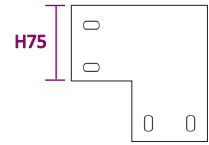
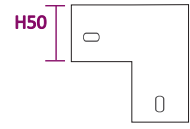
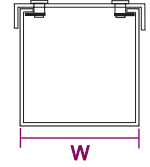

ARTIM METAL ELEKTRİK A.Ş.

* Farklı kalınlık ve ölçülerde üretim yapılabılır.
* Malzeme ağırlıkları yaklaşık değerlerdir, ± %10 değişiklik gösterebilir.
* Malzeme kalınlık toleransı ± %10 dur.
* Lütfen siparişlerinizde sipariş kodu veya ürün kodu ve Kaplama şeklini belirtiniz.

* We can produce cable trays different thickness and dimensions
* Cable trays are shown approximately weight, they could change ± %10 difference.
* Cable trays thickness tolerances are shown ± %10.
* Please indicate order code and coating type in your orders.

ATR SERIES

DIS BÜKEY DÖNÜS (SABIT)

CONSTANT OUTSIDE VERTICAL BENS

SICAK DALDIRMA (SD)

HOT DIP GALVANIZED (HDG)

TS EN ISO 1461



H50 = Tek delikli
H50 = One hole

H75 = İki delikli
H75 = Two holes

H100 = H150 = Dört delikli
H100 = H150 = Four holes

H50

Sipariş Kodu Order Code	W (mm)	T (mm)	Ağırlık (kg/ad) Weight (kg/pcs)	Barkod Kodu Barcode Code
50 ATR 050B S2	50	1.50 mm	1,359	2006450
ATRK 050B S2	50	1.50 mm	0,484	2006950
50 ATR 075B S2	75	1.50 mm	2,037	2006451
ATRK 075B S2	75	1.50 mm	0,726	2006951
50 ATR 100B S2	100	1.50 mm	1,733	2006452
ATRK 100B S2	100	1.50 mm	0,831	2006952
50 ATR 150B S2	150	1.50 mm	2,173	2006453
ATRK 150B S2	150	1.50 mm	1,243	2006953
50 ATR 200B S2	200	1.50 mm	2,492	2006454
ATRK 200B S2	200	1.50 mm	1,524	2006954

H75

Sipariş Kodu Order Code	W (mm)	T (mm)	Ağırlık (kg/ad) Weight (kg/pcs)	Barkod Kodu Barcode Code
75 ATR 07B S2	75	1.50 mm	1,527	2006455
ATRK 075B S2	75	1.50 mm	0,726	2006951
75 ATR 100B S2	100	1.50 mm	2,035	2006456
ATRK 100B S2	100	1.50 mm	0,831	2006952
75 ATR 150B S2	150	1.50 mm	2,475	2006457
ATRK 150B S2	150	1.50 mm	1,243	2006953
75 ATR 200B S2	200	1.50 mm	2,789	2006458
ATRK 200B S2	200	1.50 mm	1,524	2006954

H100

Sipariş Kodu Order Code	W (mm)	T (mm)	Ağırlık (kg/ad) Weight (kg/pcs)	Barkod Kodu Barcode Code
100 ATR 100B S2	100	1.50 mm	2,255	2006459
ATRK 100B S2	100	1.50 mm	0,831	2006952
100 ATR 150B S2	150	1.50 mm	2,701	2006460
ATRK 150B S2	150	1.50 mm	1,243	2006953
100 ATR 200B S2	200	1.50 mm	3,020	2006461
ATRK 200B S2	200	1.50 mm	1,524	2006954

H150

Sipariş Kodu Order Code	W (mm)	T (mm)	Ağırlık (kg/ad) Weight (kg/pcs)	Barkod Kodu Barcode Code
150 ATR 150B S2	150	1.50 mm	4,050	2006462
ATRK 150B S2	150	1.50 mm	1,243	2006953
150 ATR 200B S2	200	1.50 mm	4,529	2006463
ATRK 200B S2	200	1.50 mm	1,524	2006954

H = YÜKSEKLİK = HEIGHT / W = GENİŞLİK = WIDTH / T = KALINLIK = THICKNESS

H ATR 100 B S2

Yükseklik Kanal Tipi Genişlik Modül
Height Type Width Module

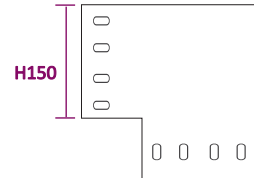
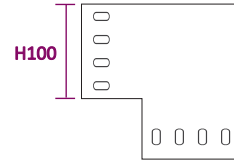
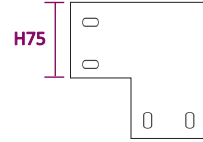
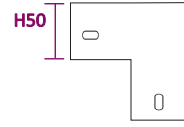
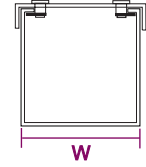

* Farklı kalınlık ve ölçülerde üretim yapılabılır.
* Malzeme ağırlıkları yaklaşık değerlerdir, ± %10 değişiklik gösterebilir.
* Malzeme kalınlık toleransı ± %10 dur.
* Lütfen siparişlerinizde sipariş kodu veya ürün kodu ve Kaplama şeklini belirtiniz.

* We can produce cable trays different thickness and dimensions
* Cable trays are shown approximately weight, they could change ± %10 difference.
* Cable trays thickness tolerances are shown ± %10 .
* Please indicate order code and coating type in your orders.

ATR SERIES

EK ELEMANI

STRAIGHT CONNECTION COUPLER

PREGALVANIZ (PG)
PREGALVANIZED (PG)
TS EN 10346



H50 = Tek delikli
H50 = One hole

H75 = İki delikli
H75 = Two holes

H100 = H150 = Dört delikli
H100 = H150 = Four holes

H50				
Sipariş Kodu Order Code	L (mm)	T (mm)	Ağırlık (kg/ad) Weight (kg/pcs)	Barkod Kodu Barcode Code
50 ATR 1	74 mm	1.20 mm	0,110	2006550

H75				
Sipariş Kodu Order Code	L (mm)	T (mm)	Ağırlık (kg/ad) Weight (kg/pcs)	Barkod Kodu Barcode Code
75 ATR 1	74 mm	1.20 mm	0,154	2006560

H100				
Sipariş Kodu Order Code	L (mm)	T (mm)	Ağırlık (kg/ad) Weight (kg/pcs)	Barkod Kodu Barcode Code
100 ATR 1	74 mm	1.20 mm	0,192	2006570

H150				
Sipariş Kodu Order Code	L (mm)	T (mm)	Ağırlık (kg/ad) Weight (kg/pcs)	Barkod Kodu Barcode Code
150 ATR 1	74 mm	1.20 mm	0,285	2006580

H = YÜKSEKLİK = HEIGHT / T = KALINLIK = THICKNESS / L = BOY = LENGTH

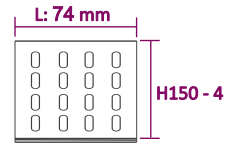
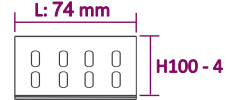
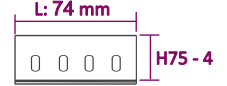
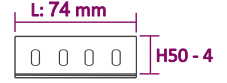

SICAK DALDIRMA (SD)
HOT DIP GALVANIZED (SD)
TS EN ISO 1461

H50				
Sipariş Kodu Order Code	L (mm)	T (mm)	Ağırlık (kg/ad) Weight (kg/pcs)	Barkod Kodu Barcode Code
50 ATR 1	74 mm	1.20 mm	0,121	2006550

H75				
Sipariş Kodu Order Code	L (mm)	T (mm)	Ağırlık (kg/ad) Weight (kg/pcs)	Barkod Kodu Barcode Code
75 ATR 1	74 mm	1.20 mm	0,172	2006560

H100				
Sipariş Kodu Order Code	L (mm)	T (mm)	Ağırlık (kg/ad) Weight (kg/pcs)	Barkod Kodu Barcode Code
100 ATR 1	74 mm	1.20 mm	0,215	2006570

H150				
Sipariş Kodu Order Code	L (mm)	T (mm)	Ağırlık (kg/ad) Weight (kg/pcs)	Barkod Kodu Barcode Code
150 ATR 1	74 mm	1.20 mm	0,319	2006580

H = YÜKSEKLİK = HEIGHT / T = KALINLIK = THICKNESS / L = BOY = LENGTH

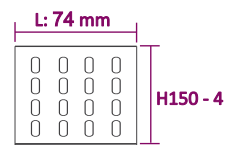
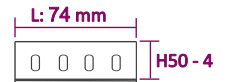

PLASTİK / PLASTIC

Sipariş Kodu Order Code	Ebat Size	T (mm)	Ağırlık (kg/ad) Weight (kg/pcs)	Barkod Kodu Barcode Code
ATR PLS KT	-	1.20 mm	0,030	2006590

ARTIM METAL ELEKTRİK A.Ş.

* Farklı kalınlık ve ölçülerde üretim yapılabılır.
* Malzeme ağırlıkları yaklaşık değerlerdir, \pm %10 değişiklik gösterebilir.
* Malzeme kalınlık toleransı \pm %10 dur.
* Lütfen siparişlerinizde sipariş kodu veya ürün kodu ve Kaplama şeklini belirtiniz.

* We can produce cable trays different thickness and dimensions
* Cable trays are shown approximately weight, they could change \pm %10 difference.
* Cable trays thickness tolerances are shown \pm %10 .
* Please indicate order code and coating type in your orders.

art

POWER CARRYING SOLUTIONS



KABLO MERDİVEN SİSTEMLERİ

CABLE LADDER SYSTEMS

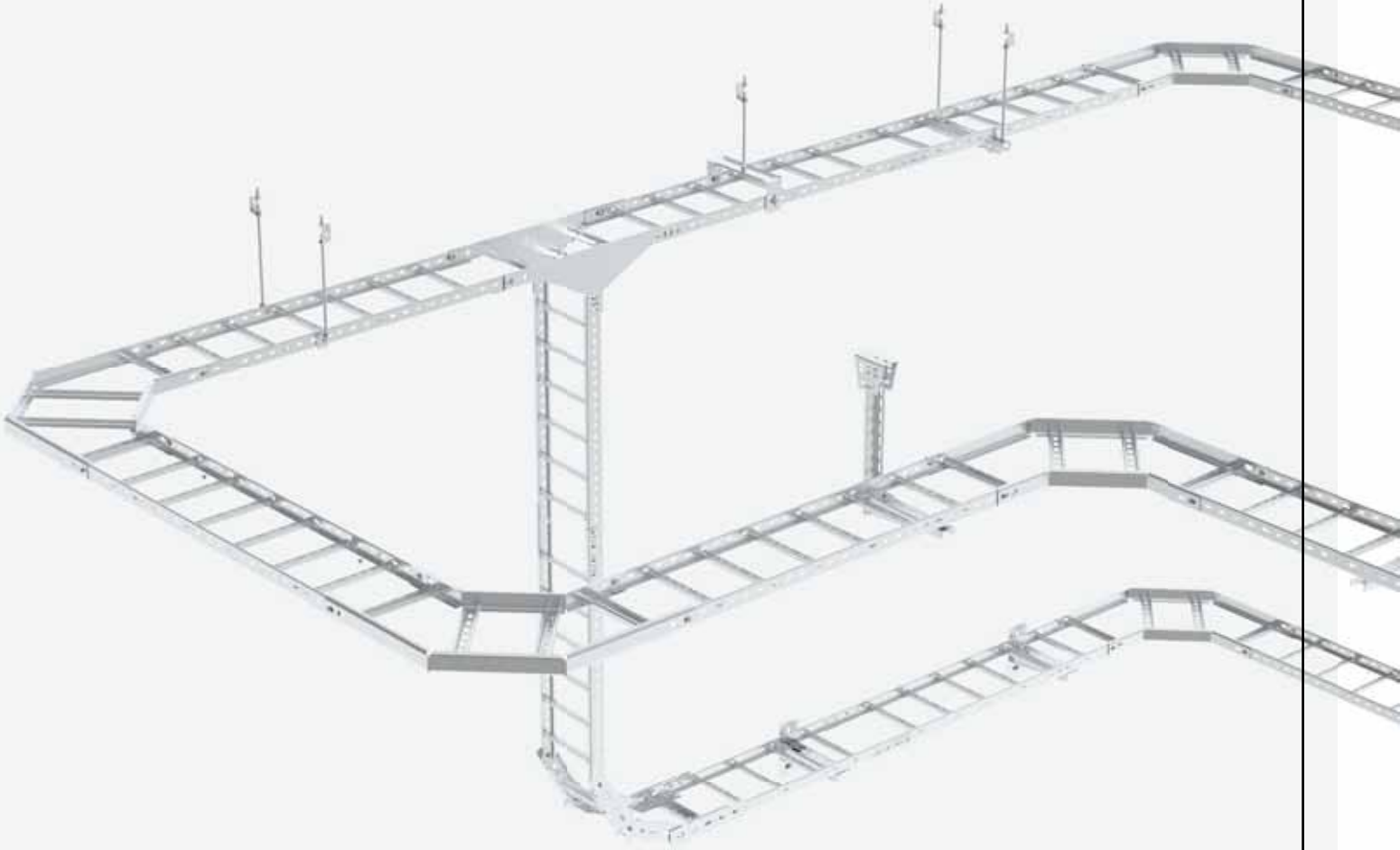

H40 AKM SERIES

PERÇİNLİ KABLO MERDİVENİ

CABLE LADDERS WITH RIVET

PREGALVANİZ (PG)
PREGALVANİZED (PG)
TS EN 10346



Sipariş Kodu Order Code	W (mm)	T (mm)	Ağırlık (kg/m) Weight (kg/m)	Barkod Kodu Barcode Code
40 AKM 100-10	100	1.00 mm	1,187	2002001
40 AKM 200-10	200	1.00 mm	1,325	2002002
40 AKM 300-10	300	1.00 mm	1,464	2002003
40 AKM 400-10	400	1.00 mm	1,602	2002004
40 AKM 500-10	500	1.00 mm	1,741	2002005
40 AKM 600-10	600	1.00 mm	1,879	2002006

Sipariş Kodu Order Code	W (mm)	T (mm)	Ağırlık (kg/m) Weight (kg/m)	Barkod Kodu Barcode Code
40 AKM 100-12	100	1.20 mm	1,535	2002007
40 AKM 200-12	200	1.20 mm	1,674	2002008
40 AKM 300-12	300	1.20 mm	1,812	2002009
40 AKM 400-12	400	1.20 mm	1,951	2002010
40 AKM 500-12	500	1.20 mm	2,089	2002011
40 AKM 600-12	600	1.20 mm	2,228	2002012

H = YÜKSEKLİK = HEIGHT / W = GENİŞLİK = WIDTH / T = KALINLIK = THICKNESS

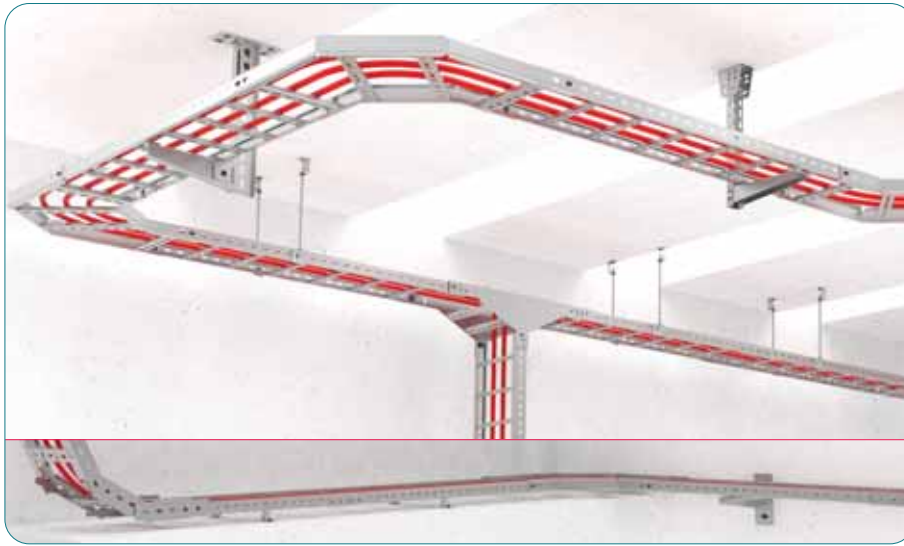

7 basamak (standart üretim)
7 rungs (standart product)

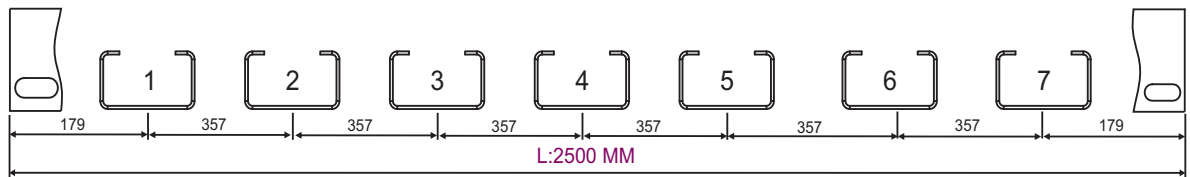

ARTIM METAL ELEKTRİK A.Ş.

- * Farklı kalınlık ve ölçülerde üretim yapılabılır.
- * Malzeme ağırlıkları yaklaşık değerlerdir, \pm %10 değişiklik gösterebilir.
- * Malzeme kalınlık toleransı \pm %10 dur.
- * Lütfen siparişlerinizde sipariş kodu veya ürün kodu ve kaplama şeklini belirtiniz.

- * We can produce cable trays different thickness and dimensions
- * Cable trays are shown approximately weight, they could change \pm %10 difference.
- * Cable trays thickness tolerances are shown \pm %10 .
- * Please indicate order code and coating type in your orders.

40 AKM100-10

Yükseklik Kanal Tipi Genişlik Kalınlık
Height Type Width Thickness

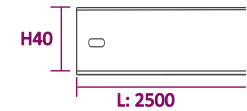
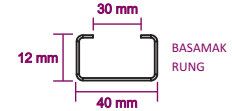
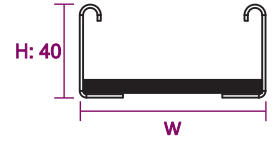
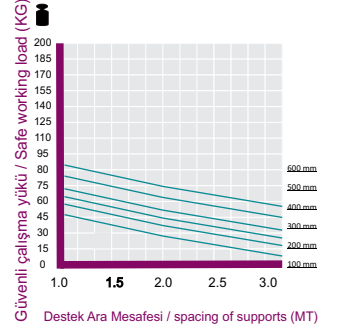

H40 AKM SERIES

KAYNAKLI KABLO MERDİVENİ

CABLE LADDERS WELDED

SICAK DALDIRMA (SD)

HOT DIP GALVANIZED (HDG)

TS EN ISO 1461



1.20 mm

Sipariş Kodu Order Code	W (mm)	T1/T2 (mm)	Ağırlık (kg/m) Weight (kg/m)	Barkod Kodu Barcode Code
40 AKM 100-12	100	1.20 mm	1,728	2002007
40 AKM 200-12	200	1.20 mm	1,932	2002008
40 AKM 300-12	300	1.20 mm	2,137	2002009
40 AKM 400-12	400	1.20 mm	2,341	2002010
40 AKM 500-12	500	1.20 mm	2,546	2002011
40 AKM 600-12	600	1.20 mm	2,750	2002012

1.50 mm

Sipariş Kodu Order Code	W (mm)	T1/T2 (mm)	Ağırlık (kg/m) Weight (kg/m)	Barkod Kodu Barcode Code
40 AKM 100-15	100	1.50 mm	2,016	2002017
40 AKM 200-15	200	1.50 mm	2,254	2002018
40 AKM 300-15	300	1.50 mm	2,493	2002019
40 AKM 400-15	400	1.50 mm	2,731	2002020
40 AKM 500-15	500	1.50 mm	2,970	2002021
40 AKM 600-15	600	1.50 mm	3,209	2002022
40 AKM 700-15	700	1.50 mm	3,447	2002023
40 AKM 800-15	800	1.50 mm	3,686	2002024
40 AKM 900-15	900	1.50 mm	3,924	2002025
40 AKM 1000-15	1.000	1.50 mm	4,163	2002026

2.00 mm

Sipariş Kodu Order Code	W (mm)	T1/T2 (mm)	Ağırlık (kg/m) Weight (kg/m)	Barkod Kodu Barcode Code
40 AKM 100-20	100	2.00 / 1.50 mm	2,655	2002027
40 AKM 200-20	200	2.00 / 1.50 mm	2,893	2002028
40 AKM 300-20	300	2.00 / 1.50 mm	3,132	2002029
40 AKM 400-20	400	2.00 / 1.50 mm	3,370	2002030
40 AKM 500-20	500	2.00 / 1.50 mm	3,609	2002031
40 AKM 600-20	600	2.00 / 1.50 mm	3,848	2002032
40 AKM 700-20	700	2.00 / 1.50 mm	4,086	2002033
40 AKM 800-20	800	2.00 / 1.50 mm	4,325	2002034
40 AKM 900-20	900	2.00 / 1.50 mm	4,563	2002035
40 AKM 1000-20	1.000	2.00 / 1.50 mm	4,802	2002036

H = YÜKSEKLİK = HEIGHT / W = GENİŞLİK = WIDTH / T = KALINLIK = THICKNESS

8 basamak (standart üretim)
8 rungs (standart product)

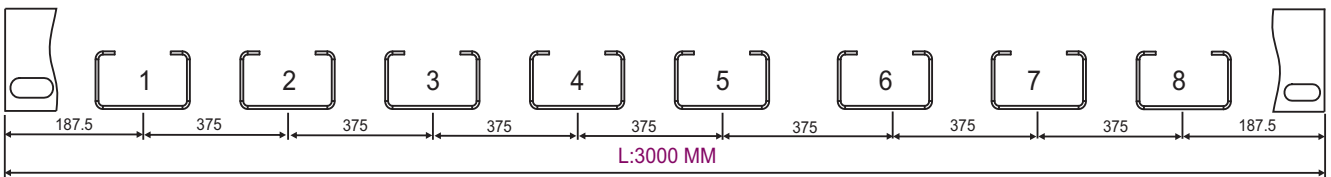

40 AKM 100-12

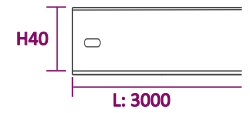
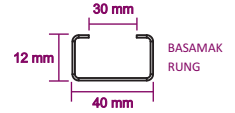
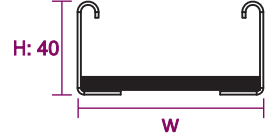
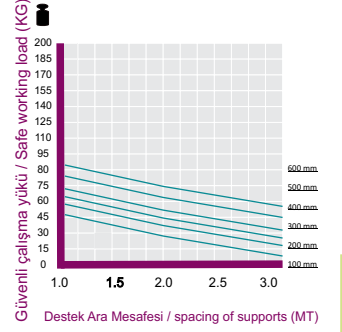

* Farklı kalınlık ve ölçülerde üretim yapılabılır.
* Malzeme ağırlıkları yaklaşık değerlerdir, \pm %10 değişiklik gösterebilir.
* Malzeme kalınlık toleransı \pm %10 dur.
* Lütfen siparişlerinizde sipariş kodu veya ürün kodu ve kaplama şeklini belirtiniz.

* We can produce cable trays different thickness and dimensions
* Cable trays are shown approximately weight, they could change \pm %10 difference.
* Cable trays thickness tolerances are shown \pm %10 .
* Please indicate order code and coating type in your orders.

H60 AKM SERIES

PERÇİNLİ KABLO MERDİVENİ

CABLE LADDERS WITH RIVET

PREGALVANİZ (PG)
PREGALVANIZED (PG)
TS EN 10346



Sipariş Kodu Order Code	W (mm)	T (mm)	Ağırlık (kg/m) Weight (kg/m)	Barkod Kodu Barcode Code
60 AKM 100-10	100	1.00 mm	1,469	2002013
60 AKM 200-10	200	1.00 mm	1,608	2002014
60 AKM 300-10	300	1.00 mm	1,746	2002015
60 AKM 400-10	400	1.00 mm	1,885	2002016
60 AKM 500-10	500	1.00 mm	2,023	2002017
60 AKM 600-10	600	1.00 mm	2,162	2002018

Sipariş Kodu Order Code	W (mm)	T (mm)	Ağırlık (kg/m) Weight (kg/m)	Barkod Kodu Barcode Code
60 AKM 100-12	100	1.20 mm	1,912	2002019
60 AKM 200-12	200	1.20 mm	2,051	2002020
60 AKM 300-12	300	1.20 mm	2,189	2002021
60 AKM 400-12	400	1.20 mm	2,328	2002022
60 AKM 500-12	500	1.20 mm	2,466	2002023
60 AKM 600-12	600	1.20 mm	2,605	2002024

H = YÜKSEKLİK = HEIGHT / W = GENİŞLİK = WIDTH / T = KALINLIK = THICKNESS

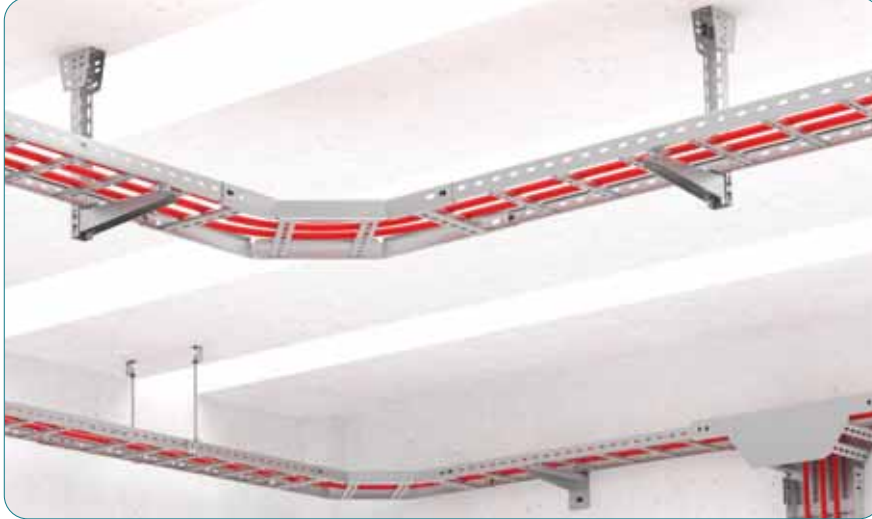

7 basamak (standart üretim)
7 rungs (standart product)

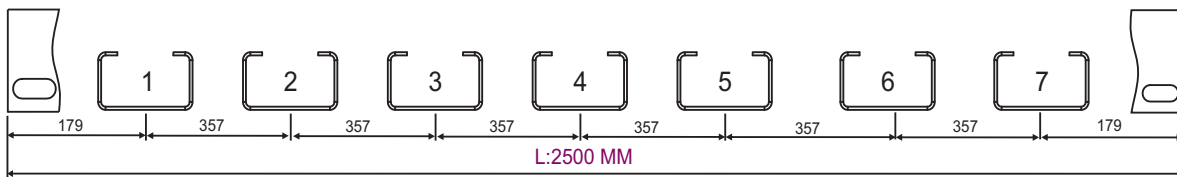

ARTIM METAL ELEKTRİK A.Ş.

60 AKM100-10

Yükseklik Kanal Tipi Genişlik Kalınlık
Height Type Width Thickness

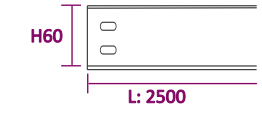
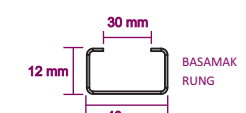
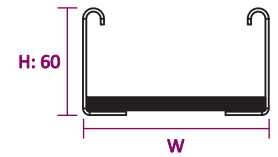
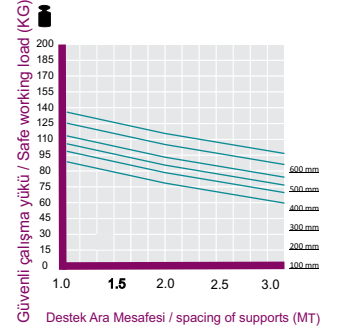

* Farklı kalınlık ve ölçülerde üretim yapılabılır.
* Malzeme ağırlıkları yaklaşık değerlerdir, \pm %10 değişiklik gösterebilir.
* Malzeme kalınlık toleransı \pm %10 dur.
* Lütfen siparişlerinizde sipariş kodu veya ürün kodu ve Kaplama şeklini belirtiniz.

* We can produce cable trays different thickness and dimensions
* Cable trays are shown approximately weight, they could change \pm %10 difference.
* Cable trays thickness tolerances are shown \pm %10 .
* Please indicate order code and coating type in your orders.

H60 AKM SERIES

KAYNAKLI KABLO MERDİVENİ

CABLE LADDERS WELDED

SICAK DALDIRMA (SD)

HOT DIP GALVANIZED (HDG)

TS EN ISO 1461



1.20 mm

Sipariş Kodu Order Code	W (mm)	T1/T2 (mm)	Ağırlık (kg/m) Weight (kg/m)	Barkod Kodu Barcode Code
60 AKM 100-12	100	1.20 mm	2,142	2002037
60 AKM 200-12	200	1.20 mm	2,347	2002038
60 AKM 300-12	300	1.20 mm	2,551	2002039
60 AKM 400-12	400	1.20 mm	2,756	2002040
60 AKM 500-12	500	1.20 mm	2,960	2002041
60 AKM 600-12	600	1.20 mm	3,165	2002042
60 AKM 700-12	700	1.20 mm	3,369	2002043
60 AKM 800-12	800	1.20 mm	3,574	2002044
60 AKM 900-12	900	1.20 mm	3,778	2002045
60 AKM 1000-12	1.000	1.20 mm	3,983	2002046

1.50 mm

Sipariş Kodu Order Code	W (mm)	T1/T2 (mm)	Ağırlık (kg/m) Weight (kg/m)	Barkod Kodu Barcode Code
60 AKM 100-15	100	1.50 mm	2,499	2002047
60 AKM 200-15	200	1.50 mm	2,738	2002048
60 AKM 300-15	300	1.50 mm	2,976	2002049
60 AKM 400-15	400	1.50 mm	3,215	2002050
60 AKM 500-15	500	1.50 mm	3,454	2002051
60 AKM 600-15	600	1.50 mm	3,692	2002052
60 AKM 700-15	700	1.50 mm	3,931	2002053
60 AKM 800-15	800	1.50 mm	4,169	2002054
60 AKM 900-15	900	1.50 mm	4,408	2002055
60 AKM 1000-15	1.000	1.50 mm	4,646	2002056

2.00 mm

Sipariş Kodu Order Code	W (mm)	T1/T2 (mm)	Ağırlık (kg/m) Weight (kg/m)	Barkod Kodu Barcode Code
60 AKM 100-20	100	2.00 /1.50 mm	3,311	2002057
60 AKM 200-20	200	2.00 /1.50 mm	3,550	2002058
60 AKM 300-20	300	2.00 /1.50 mm	3,788	2002059
60 AKM 400-20	400	2.00 /1.50 mm	4,027	2002060
60 AKM 500-20	500	2.00 /1.50 mm	4,265	2002061
60 AKM 600-20	600	2.00 /1.50 mm	4,504	2002062
60 AKM 700-20	700	2.00 /1.50 mm	4,742	2002063
60 AKM 800-20	800	2.00 /1.50 mm	4,981	2002064
60 AKM 900-20	900	2.00 /1.50 mm	5,220	2002065
60 AKM 1000-20	1.000	2.00 /1.50 mm	5,458	2002066

H = YÜKSEKLİK = HEIGHT / W = GENİŞLİK = WIDTH / T = KALINLIK = THICKNESS

60 AKM 100-12

Yükseklik Kanal Tipi Genişlik Kalınlık
Height Type Width Thickness

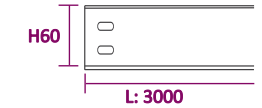
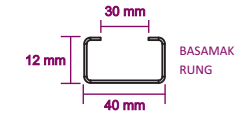
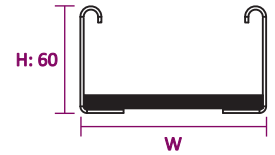
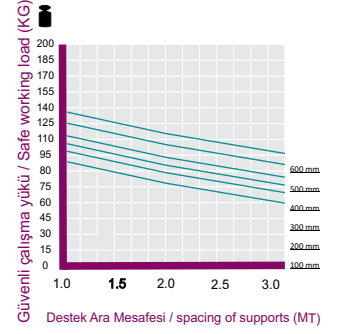

* Farklı kalınlık ve ölçülerde üretim yapıla bilinir.
* Malzeme ağırlıkları yaklaşık değerlerdir, ± %10 değişiklik gösterebilir.
* Malzeme kalınlık toleransı ± %10 dur.
* Lütfen siparişlerinizde sipariş kodu veya ürün kodu ve Kaplama şeklini belirtiniz.

* We can produce cable trays different thickness and dimensions
* Cable trays are shown approximately weight, they could change ± %10 difference.
* Cable trays thickness tolerances are shown ± %10 .
* Please indicate order code and coating type in your orders.

H100 AKM SERIES

KAYNAKLI KABLO MERDİVENİ

CABLE LADDERS WELDED

SICAK DALDIRMA (SD)
HOT DIP GALVANIZED (HDG)
TS EN ISO 1461



1.50 mm

60 AKM100-10

Sipariş Kodu Order Code	W (mm)	T1/T2 (mm)	Ağırlık (kg/m) Weight (kg/m)	Barkod Kodu Barcode Code
100 AKM 100-15	100	1.50 mm	3,495	2002067
100 AKM 200-15	200	1.50 mm	3,814	2002068
100 AKM 300-15	300	1.50 mm	4,133	2002069
100 AKM 400-15	400	1.50 mm	4,452	2002070
100 AKM 500-15	500	1.50 mm	4,771	2002071
100 AKM 600-15	600	1.50 mm	5,090	2002072
100 AKM 700-15	700	1.50 mm	5,410	2002073
100 AKM 800-15	800	1.50 mm	5,729	2002074
100 AKM 900-15	900	1.50 mm	6,048	2002075
100 AKM 1000-15	1.000	1.50 mm	6,367	2002076

Yükseklik Kanal Tipi Genişlik Kalınlık
Height Type Width Thickness

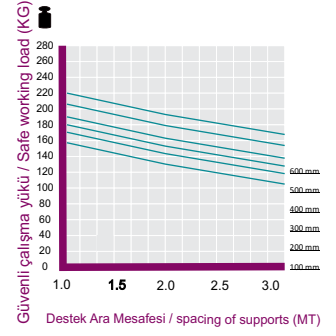

2.00 mm

Sipariş Kodu Order Code	W (mm)	T1/T2 (mm)	Ağırlık (kg/m) Weight (kg/m)	Barkod Kodu Barcode Code
100 AKM 100-20	100	2.00 /1.50 mm	4,635	2002077
100 AKM 200-20	200	2.00 /1.50 mm	4,954	2002078
100 AKM 300-20	300	2.00 /1.50 mm	5,273	2002079
100 AKM 400-20	400	2.00 /1.50 mm	5,592	2002080
100 AKM 500-20	500	2.00 /1.50 mm	5,911	2002081
100 AKM 600-20	600	2.00 /1.50 mm	6,230	2002082
100 AKM 700-20	700	2.00 /1.50 mm	6,549	2002083
100 AKM 800-20	800	2.00 /1.50 mm	6,869	2002084
100 AKM 900-20	900	2.00 /1.50 mm	7,188	2002085
100 AKM 1000-20	1.000	2.00 /1.50 mm	7,507	2002086

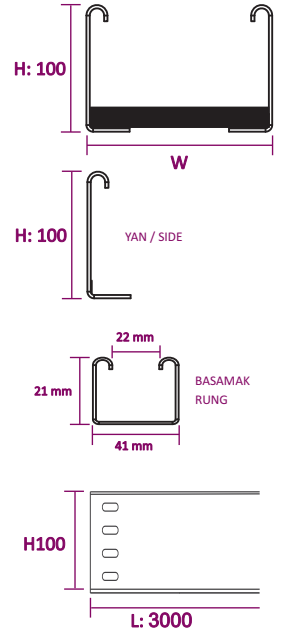

H = YÜKSEKLİK = HEIGHT / W = GENİŞLİK = WIDTH / T = KALINLIK = THICKNESS

8 basamak (standart üretim)
8 rungs (standart product)

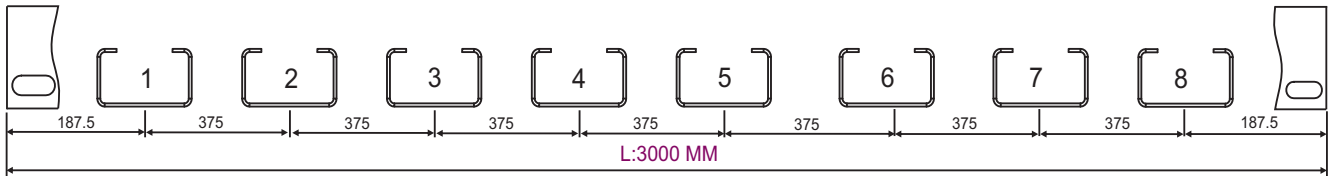

ARTIM METAL ELEKTRİK A.Ş.

- * Farklı kalınlık ve ölçülerde üretim yapılabılır.
- * Malzeme ağırlıkları yaklaşık değerlerdir, \pm %10 değişiklik gösterebilir.
- * Malzeme kalınlık toleransı \pm %10 dur.
- * Lütfen siparişlerinizde sipariş kodu veya ürün kodu ve Kaplama şeklini belirtiniz.

- * We can produce cable trays different thickness and dimensions
- * Cable trays are shown approximately weight, they could change \pm %10 difference.
- * Cable trays thickness tolerances are shown \pm %10 .
- * Please indicate order code and coating type in your orders.

H150 AKM SERIES

KAYNAKLI KABLO MERDİVENİ

CABLE LADDERS WELDED

SICAK DALDIRMA (SD)

HOT DIP GALVANIZED (HDG)

TS EN ISO 1461



Sipariş Kodu Order Code	W (mm)	T1/T2 (mm)	Ağırlık (kg/m) Weight (kg/m)	Barkod Kodu Barcode Code
150 AKM 200-15	200	1.50 mm	5,023	2002150
150 AKM 300-15	300	1.50 mm	5,342	2002151
150 AKM 400-15	400	1.50 mm	5,661	2002152
150 AKM 500-15	500	1.50 mm	5,980	2002153
150 AKM 600-15	600	1.50 mm	6,299	2002154
150 AKM 700-15	700	1.50 mm	6,618	2002155
150 AKM 800-15	800	1.50 mm	6,938	2002156
150 AKM 900-15	900	1.50 mm	7,257	2002157
150 AKM 1000-15	1.000	1.50 mm	7,576	2002158

1.50 mm

150 AKM100-10

Yükseklik Kanal Tipi Genişlik Kalınlık
Height Type Width Thickness

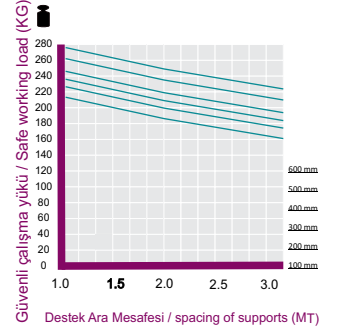

Sipariş Kodu Order Code	W (mm)	T1/T2 (mm)	Ağırlık (kg/m) Weight (kg/m)	Barkod Kodu Barcode Code
150 AKM 200-20	200	2.00 / 1.50 mm	6,594	2002159
150 AKM 300-20	300	2.00 / 1.50 mm	6,913	2002160
150 AKM 400-20	400	2.00 / 1.50 mm	7,233	2002161
150 AKM 500-20	500	2.00 / 1.50 mm	7,552	2002162
150 AKM 600-20	600	2.00 / 1.50 mm	7,871	2002163
150 AKM 700-20	700	2.00 / 1.50 mm	8,190	2002164
150 AKM 800-20	800	2.00 / 1.50 mm	8,509	2002165
150 AKM 900-20	900	2.00 / 1.50 mm	8,828	2002166
150 AKM 1000-20	1.000	2.00 / 1.50 mm	9,148	2002167

2.00 mm

H = YÜKSEKLİK = HEIGHT / W = GENİŞLİK = WIDTH / T = KALINLIK = THICKNESS

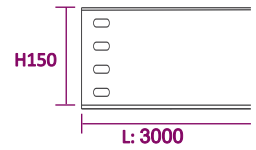
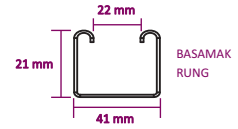
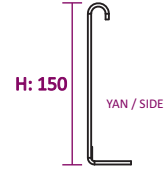
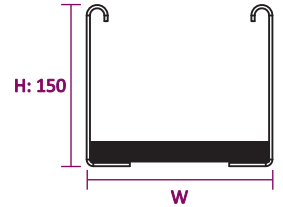

8 basamak (standart üretim)
8 rungs (standart product)

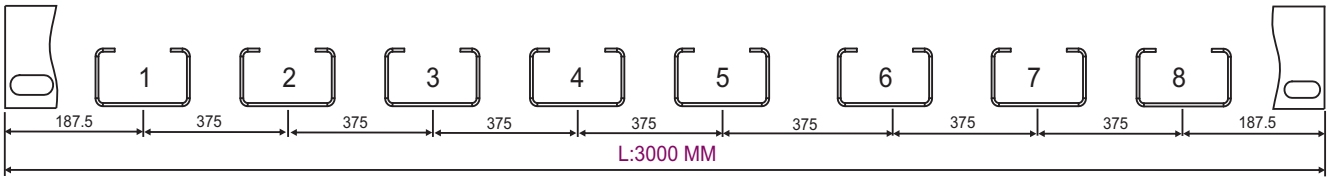

* Farklı kalınlık ve ölçülerde üretim yapılabılır.
* Malzeme ağırlıkları yaklaşık değerlerdir, \pm %10 değişiklik gösterebilir.
* Malzeme kalınlık toleransı \pm %10 dur.
* Lütfen siparişlerinizde sipariş kodu veya ürün kodu ve kaplama şeklini belirtiniz.

* We can produce cable trays different thickness and dimensions
* Cable trays are shown approximately weight, they could change \pm %10 difference.
* Cable trays thickness tolerances are shown \pm %10 .
* Please indicate order code and coating type in your orders.

AKM SERIES

90° YATAY DÖNÜS

90° BEND

SICAK DALDIRMA (SD)
HOT DIP GALVANIZED (HDG)
TS EN ISO 1461



H40 = Tek delikli
H40 = One hole

H60 = İki delikli
H60 = Two holes

H100 = H150 = Dört delikli
H100 = H150 = Four holes



ARTIM METAL ELEKTRİK A.Ş.

H40

Sipariş Kodu Order Code	W (mm)	T1/T2 (mm)	Ağırlık (kg/ad) Weight (kg/pcs)	Barkod Kodu Barcode Code
40 AKM 100Y	100	1.50 mm	1,381	2002100
40 AKM 200Y	200	1.50 mm	1,780	2002101
40 AKM 300Y	300	1.50 mm	2,390	2002102
40 AKM 400Y	400	2.00 mm	3,738	2002103
40 AKM 500Y	500	2.00 mm	4,338	2002104
40 AKM 600Y	600	2.00 mm	4,938	2002105

H60

Sipariş Kodu Order Code	W (mm)	T1/T2 (mm)	Ağırlık (kg/ad) Weight (kg/pcs)	Barkod Kodu Barcode Code
60 AKM 100Y	100	1.50 mm	1,706	2002116
60 AKM 200Y	200	1.50 mm	2,236	2002117
60 AKM 300Y	300	1.50 mm	2,748	2002118
60 AKM 400Y	400	2.00 mm	4,250	2002119
60 AKM 500Y	500	2.00 mm	4,910	2002120
60 AKM 600Y	600	2.00 mm	5,561	2002121
60 AKM 700Y	700	2.00 mm	6,235	2002122
60 AKM 800Y	800	2.00 mm	6,891	2002123
60 AKM 900Y	900	2.00 mm	7,547	2002124
60 AKM 1000Y	1.000	2.00 mm	8,202	2002125

H100

Sipariş Kodu Order Code	W (mm)	T1/T2 (mm)	Ağırlık (kg/ad) Weight (kg/pcs)	Barkod Kodu Barcode Code
100 AKM 100Y	100	1.50 mm	2,350	2002136
100 AKM 200Y	200	1.50 mm	3,240	2002137
100 AKM 300Y	300	1.50 mm	4,080	2002138
100 AKM 400Y	400	2.00 mm	5,860	2002139
100 AKM 500Y	500	2.00 mm	6,800	2002140
100 AKM 600Y	600	2.00 mm	7,745	2002141
100 AKM 700Y	700	2.00 mm	8,720	2002142
100 AKM 800Y	800	2.00 mm	9,660	2002143
100 AKM 900Y	900	2.00 mm	10,605	2002144
100 AKM 1000Y	1.000	2.00 mm	11,545	2002145

H150

Sipariş Kodu Order Code	W (mm)	T1/T2 (mm)	Ağırlık (kg/ad) Weight (kg/pcs)	Barkod Kodu Barcode Code
150 AKM 200Y	200	1.50 mm	3,970	2002146
150 AKM 300Y	300	1.50 mm	4,920	2002147
150 AKM 400Y	400	2.00 mm	7,125	2002148
150 AKM 500Y	500	2.00 mm	8,210	2002149
150 AKM 600Y	600	2.00 mm	9,305	2002150
150 AKM 700Y	700	2.00 mm	10,420	2002151
150 AKM 800Y	800	2.00 mm	11,505	2002152
150 AKM 900Y	900	2.00 mm	12,600	2002153
150 AKM 1000Y	1.000	2.00 mm	13,685	2002154

H = YÜKSEKLİK = HEIGHT / W = GENİŞLİK = WIDTH / T = KALINLIK = THICKNESS

H AKM100 Y

Yükseklik Kanal Tipi Genişlik Modül
Height Type Width Module

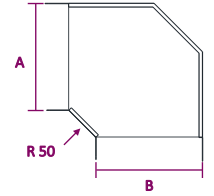
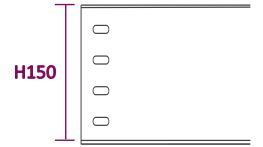
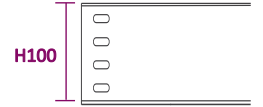
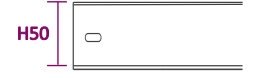

Dönüşlerde "A-B" ölçüleri eşit olarak üretilmektedir. İsteğe bağlı olarak farklı ölçülerde üretim yapılır.

Bends are produced same dimension for "A-B" as well as we can produce special dimensions regarding your inquiry.

* Farklı kalınlık ve ölçülerde üretim yapılabılır.
* Malzeme ağırlıkları yaklaşık değerlerdir, ± %10 değişiklik gösterebilir.
* Malzeme kalınlık toleransı ± %10 dur.
* Lütfen siparişlerinizde sipariş kodu veya ürün kodu ve Kaplama şeklini belirtiniz.

* We can produce cable trays different thickness and dimensions
* Cable trays are shown approximately weight, they could change ± %10 difference.
* Cable trays thickness tolerances are shown ± %10 .
* Please indicate order code and coating type in your orders.

AKM SERIES

90° YATAY DÖNÜS R300

90° BEND R300

SICAK DALDIRMA (SD)

HOT DIP GALVANIZED (HDG)

TS EN ISO 1461



H40 = Tek delikli
H40 = One hole

H60 = İki delikli
H60 = Two holes

H100 = H150 = Dört delikli
H100 = H150 = Four holes

H40

Sipariş Kodu Order Code	W (mm)	T1/T2 (mm)	Ağırlık (kg/ad) Weight (kg/pcs)	Barkod Kodu Barcode Code
40 AKM 100Y	100	1.50 mm	1,464	2002100
40 AKM 200Y	200	1.50 mm	1,887	2002101
40 AKM 300Y	300	1.50 mm	2,533	2002102
40 AKM 400Y	400	2.00 mm	3,962	2002103
40 AKM 500Y	500	2.00 mm	4,598	2002104
40 AKM 600Y	600	2.00 mm	5,234	2002105

H60

Sipariş Kodu Order Code	W (mm)	T1/T2 (mm)	Ağırlık (kg/ad) Weight (kg/pcs)	Barkod Kodu Barcode Code
60 AKM 100Y	100	1.50 mm	1,808	2002116
60 AKM 200Y	200	1.50 mm	2,370	2002117
60 AKM 300Y	300	1.50 mm	2,913	2002118
60 AKM 400Y	400	2.00 mm	4,505	2002119
60 AKM 500Y	500	2.00 mm	5,205	2002120
60 AKM 600Y	600	2.00 mm	5,895	2002121
60 AKM 700Y	700	2.00 mm	6,609	2002122
60 AKM 800Y	800	2.00 mm	7,304	2002123
60 AKM 900Y	900	2.00 mm	8,000	2002124
60 AKM 1000Y	1.000	2.00 mm	8,694	2002125

H100

Sipariş Kodu Order Code	W (mm)	T1/T2 (mm)	Ağırlık (kg/ad) Weight (kg/pcs)	Barkod Kodu Barcode Code
100 AKM 100Y	100	1.50 mm	2,491	2002136
100 AKM 200Y	200	1.50 mm	3,434	2002137
100 AKM 300Y	300	1.50 mm	4,325	2002138
100 AKM 400Y	400	2.00 mm	6,212	2002139
100 AKM 500Y	500	2.00 mm	7,208	2002140
100 AKM 600Y	600	2.00 mm	8,210	2002141
100 AKM 700Y	700	2.00 mm	9,243	2002142
100 AKM 800Y	800	2.00 mm	10,240	2002143
100 AKM 900Y	900	2.00 mm	11,241	2002144
100 AKM 1000Y	1.000	2.00 mm	12,238	2002145

H150

Sipariş Kodu Order Code	W (mm)	T1/T2 (mm)	Ağırlık (kg/ad) Weight (kg/pcs)	Barkod Kodu Barcode Code
150 AKM 200Y	200	1.50 mm	4,208	2002146
150 AKM 300Y	300	1.50 mm	5,215	2002147
150 AKM 400Y	400	2.00 mm	7,553	2002148
150 AKM 500Y	500	2.00 mm	8,703	2002149
150 AKM 600Y	600	2.00 mm	9,863	2002150
150 AKM 700Y	700	2.00 mm	11,045	2002151
150 AKM 800Y	800	2.00 mm	12,195	2002152
150 AKM 900Y	900	2.00 mm	13,356	2002153
150 AKM 1000Y	1.000	2.00 mm	14,506	2002154

H = YÜKSEKLİK = HEIGHT / W = GENİŞLİK = WIDTH / T = KALINLIK = THICKNESS

H AKM100 Y

Yükseklik | Kanal Tipi | Genişlik | Modül
Height | Type | Width | Module

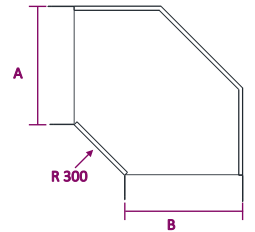
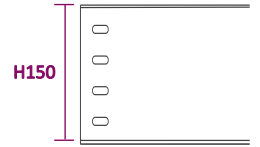
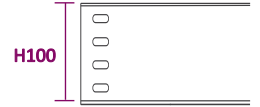
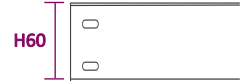
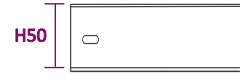

* Farklı kalınlık ve ölçülerde üretim yapılabılır.
* Malzeme ağırlıkları yaklaşık değerlerdir, ± %10 değişiklik gösterebilir.
* Malzeme kalınlık toleransı ± %10 dur.
* Lütfen siparişlerinizde sipariş kodu veya ürün kodu ve Kaplama şeklini belirtiniz.

* We can produce cable trays different thickness and dimensions
* Cable trays are shown approximately weight, they could change ± %10 difference.
* Cable trays thickness tolerances are shown ± %10 .
* Please indicate order code and coating type in your orders.

AKM SERIES

90° YATAY DÖNÜS R450

90° BEND R450

SICAK DALDIRMA (SD)
HOT DIP GALVANIZED (HDG)
TS EN ISO 1461



H40 = Tek delikli
H40 = One hole

H60 = İki delikli
H60 = Two holes

H100 = H150 = Dört delikli
H100 = H150 = Four holes

Sipariş Kodu Order Code	W (mm)	T1/T2 (mm)	Ağırlık (kg/ad) Weight (kg/pcs)	Barkod Kodu Barcode Code
40 AKM 100Y	100	1.50 mm	1,610	2002100
40 AKM 200Y	200	1.50 mm	2,075	2002101
40 AKM 300Y	300	1.50 mm	2,787	2002102
40 AKM 400Y	400	2.00 mm	4,359	2002103
40 AKM 500Y	500	2.00 mm	5,058	2002104
40 AKM 600Y	600	2.00 mm	5,758	2002105

Sipariş Kodu Order Code	W (mm)	T1/T2 (mm)	Ağırlık (kg/ad) Weight (kg/pcs)	Barkod Kodu Barcode Code
60 AKM 100Y	100	1.50 mm	1,989	2002116
60 AKM 200Y	200	1.50 mm	2,607	2002117
60 AKM 300Y	300	1.50 mm	3,204	2002118
60 AKM 400Y	400	2.00 mm	4,956	2002119
60 AKM 500Y	500	2.00 mm	5,725	2002120
60 AKM 600Y	600	2.00 mm	6,484	2002121
60 AKM 700Y	700	2.00 mm	7,270	2002122
60 AKM 800Y	800	2.00 mm	8,035	2002123
60 AKM 900Y	900	2.00 mm	8,800	2002124
60 AKM 1000Y	1.000	2.00 mm	9,564	2002125

Sipariş Kodu Order Code	W (mm)	T1/T2 (mm)	Ağırlık (kg/ad) Weight (kg/pcs)	Barkod Kodu Barcode Code
100 AKM 100Y	100	1.50 mm	2,740	2002136
100 AKM 200Y	200	1.50 mm	3,778	2002137
100 AKM 300Y	300	1.50 mm	4,757	2002138
100 AKM 400Y	400	2.00 mm	6,833	2002139
100 AKM 500Y	500	2.00 mm	7,929	2002140
100 AKM 600Y	600	2.00 mm	9,031	2002141
100 AKM 700Y	700	2.00 mm	10,168	2002142
100 AKM 800Y	800	2.00 mm	11,264	2002143
100 AKM 900Y	900	2.00 mm	12,365	2002144
100 AKM 1000Y	1.000	2.00 mm	13,461	2002145

Sipariş Kodu Order Code	W (mm)	T1/T2 (mm)	Ağırlık (kg/ad) Weight (kg/pcs)	Barkod Kodu Barcode Code
150 AKM 200Y	200	1.50 mm	4,629	2002146
150 AKM 300Y	300	1.50 mm	5,737	2002147
150 AKM 400Y	400	2.00 mm	8,308	2002148
150 AKM 500Y	500	2.00 mm	9,573	2002149
150 AKM 600Y	600	2.00 mm	10,850	2002150
150 AKM 700Y	700	2.00 mm	12,150	2002151
150 AKM 800Y	800	2.00 mm	13,415	2002152
150 AKM 900Y	900	2.00 mm	14,692	2002153
150 AKM 1000Y	1.000	2.00 mm	15,957	2002154

H = YÜKSEKLİK = HEIGHT / W = GENİŞLİK = WIDTH / T = KALINLIK = THICKNESS

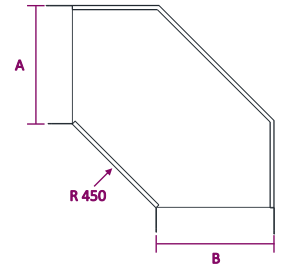
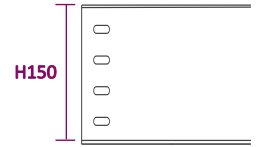
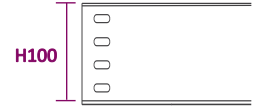
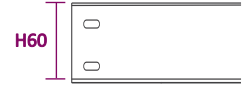
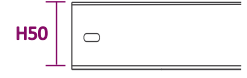
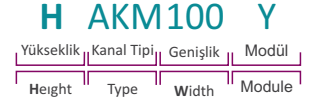

ARTIM METAL ELEKTRİK A.Ş.

* Farklı kalınlık ve ölçülerde üretim yapılabılır.
* Malzeme ağırlıkları yaklaşık değerlerdir, ± %10 değişiklik gösterebilir.
* Malzeme kalınlık toleransı ± %10 dur.
* Lütfen siparişlerinizde sipariş kodu veya ürün kodu ve Kaplama şeklini belirtiniz.

* We can produce cable trays different thickness and dimensions
* Cable trays are shown approximately weight, they could change ± %10 difference.
* Cable trays thickness tolerances are shown ± %10 .
* Please indicate order code and coating type in your orders.

AKM SERIES

90° YATAY DÖNÜS R600

90° BEND R600

SICAK DALDIRMA (SD)

HOT DIP GALVANIZED (HDG)

TS EN ISO 1461



H40 = Tek delikli

H40 = One hole

H60 = İki delikli

H60 = Two holes

H100 = H150 = Dört delikli

H100 = H150 = Four holes

H40

Sipariş Kodu Order Code	W (mm)	T1/T2 (mm)	Ağırlık (kg/ad) Weight (kg/pcs)	Barkod Kodu Barcode Code
40 AKM 100Y	100	1.50 mm	1,771	2002100
40 AKM 200Y	200	1.50 mm	2,283	2002101
40 AKM 300Y	300	1.50 mm	3,065	2002102
40 AKM 400Y	400	2.00 mm	4,794	2002103
40 AKM 500Y	500	2.00 mm	5,564	2002104
40 AKM 600Y	600	2.00 mm	6,333	2002105

H60

Sipariş Kodu Order Code	W (mm)	T1/T2 (mm)	Ağırlık (kg/ad) Weight (kg/pcs)	Barkod Kodu Barcode Code
60 AKM 100Y	100	1.50 mm	2,188	2002116
60 AKM 200Y	200	1.50 mm	2,868	2002117
60 AKM 300Y	300	1.50 mm	3,525	2002118
60 AKM 400Y	400	2.00 mm	5,451	2002119
60 AKM 500Y	500	2.00 mm	6,298	2002120
60 AKM 600Y	600	2.00 mm	7,133	2002121
60 AKM 700Y	700	2.00 mm	7,997	2002122
60 AKM 800Y	800	2.00 mm	8,838	2002123
60 AKM 900Y	900	2.00 mm	9,680	2002124
60 AKM 1000Y	1.000	2.00 mm	10,520	2002125

H100

Sipariş Kodu Order Code	W (mm)	T1/T2 (mm)	Ağırlık (kg/ad) Weight (kg/pcs)	Barkod Kodu Barcode Code
100 AKM 100Y	100	1.50 mm	3,014	2002136
100 AKM 200Y	200	1.50 mm	4,156	2002137
100 AKM 300Y	300	1.50 mm	5,233	2002138
100 AKM 400Y	400	2.00 mm	7,516	2002139
100 AKM 500Y	500	2.00 mm	8,722	2002140
100 AKM 600Y	600	2.00 mm	9,934	2002141
100 AKM 700Y	700	2.00 mm	11,184	2002142
100 AKM 800Y	800	2.00 mm	12,390	2002143
100 AKM 900Y	900	2.00 mm	13,602	2002144
100 AKM 1000Y	1.000	2.00 mm	14,808	2002145

H150

Sipariş Kodu Order Code	W (mm)	T1/T2 (mm)	Ağırlık (kg/ad) Weight (kg/pcs)	Barkod Kodu Barcode Code
150 AKM 200Y	200	1.50 mm	5,092	2002146
150 AKM 300Y	300	1.50 mm	6,310	2002147
150 AKM 400Y	400	2.00 mm	9,139	2002148
150 AKM 500Y	500	2.00 mm	10,530	2002149
150 AKM 600Y	600	2.00 mm	11,935	2002150
150 AKM 700Y	700	2.00 mm	13,365	2002151
150 AKM 800Y	800	2.00 mm	14,756	2002152
150 AKM 900Y	900	2.00 mm	16,161	2002153
150 AKM 1000Y	1.000	2.00 mm	17,552	2002154

H = YÜKSEKLİK = HEIGHT / W = GENİŞLİK = WIDTH / T = KALINLIK = THICKNESS

H AKM100 Y

Yükseklik Kanal Tipi Genişlik Modül
Height Type Width Module

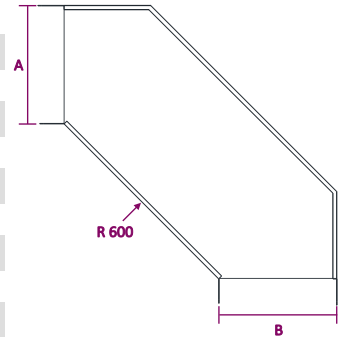
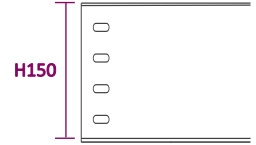
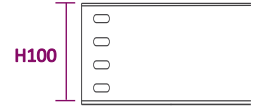
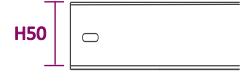

* Farklı kalınlık ve ölçülerde üretim yapıla bilinir.
* Malzeme ağırlıkları yaklaşık değerlerdir, ± %10 değişiklik gösterebilir.
* Malzeme kalınlık toleransı ± %10 dur.
* Lütfen siparişinizde sipariş kodu veya ürün kodu ve Kaplama şeklini belirtiniz.

* We can produce cable trays different thickness and dimensions
* Cable trays are shown approximately weight, they could change ± %10 difference.
* Cable trays thickness tolerances are shown ± %10 .
* Please indicate order code and coating type in your orders.

AKM SERIES

T BAĞLANTI

T BEND

SICAK DALDIRMA (SD)
HOT DIP GALVANIZED (HDG)
TS EN ISO 1461



H40 = Tek delikli
H40 = One hole

H60 = İki delikli
H60 = Two holes

H100 = H150 = Dört delikli
H100 = H150 = Four holes

Sipariş Kodu Order Code	W (mm)	T1/T2 (mm)	Ağırlık (kg/ad) Weight (kg/pcs)	Barkod Kodu Barcode Code
40 AKM 100T	100	1.50 mm	2,064	2002200
40 AKM 200T	200	1.50 mm	2,408	2002201
40 AKM 300T	300	1.50 mm	3,027	2002202
40 AKM 400T	400	2.00 mm	4,482	2002203
40 AKM 500T	500	2.00 mm	5,003	2002204
40 AKM 600T	600	2.00 mm	5,524	2002205

Sipariş Kodu Order Code	W (mm)	T1/T2 (mm)	Ağırlık (kg/ad) Weight (kg/pcs)	Barkod Kodu Barcode Code
60 AKM 100T	100	1.50 mm	2,604	2002216
60 AKM 200T	200	1.50 mm	3,031	2002217
60 AKM 300T	300	1.50 mm	3,464	2002218
60 AKM 400T	400	2.00 mm	5,073	2002219
60 AKM 500T	500	2.00 mm	5,621	2002220
60 AKM 600T	600	2.00 mm	6,166	2002221
60 AKM 700T	700	2.00 mm	6,714	2002222
60 AKM 800T	800	2.00 mm	7,258	2002223
60 AKM 900T	900	2.00 mm	7,807	2002224
60 AKM 1000T	1.000	2.00 mm	8,351	2002225

Sipariş Kodu Order Code	W (mm)	T1/T2 (mm)	Ağırlık (kg/ad) Weight (kg/pcs)	Barkod Kodu Barcode Code
100 AKM 100T	100	1.50 mm	3,675	2002236
100 AKM 200T	200	1.50 mm	4,435	2002237
100 AKM 300T	300	1.50 mm	5,200	2002238
100 AKM 400T	400	2.00 mm	7,025	2002239
100 AKM 500T	500	2.00 mm	8,835	2002240
100 AKM 600T	600	2.00 mm	8,645	2002241
100 AKM 700T	700	2.00 mm	9,455	2002242
100 AKM 800T	800	2.00 mm	10,265	2002243
100 AKM 900T	900	2.00 mm	11,080	2002244
100 AKM 1000T	1.000	2.00 mm	11,890	2002245

Sipariş Kodu Order Code	W (mm)	T1/T2 (mm)	Ağırlık (kg/ad) Weight (kg/pcs)	Barkod Kodu Barcode Code
150 AKM 200T	200	1.50 mm	5,350	2002246
150 AKM 300T	300	1.50 mm	6,165	2002247
150 AKM 400T	400	2.00 mm	8,380	2002248
150 AKM 500T	500	2.00 mm	9,265	2002249
150 AKM 600T	600	2.00 mm	10,145	2002250
150 AKM 700T	700	2.00 mm	11,025	2002251
150 AKM 800T	800	2.00 mm	11,910	2002252
150 AKM 900T	900	2.00 mm	12,890	2002253
150 AKM 1000T	1.000	2.00 mm	13,670	2002254

H = YÜKSEKLİK = HEIGHT / W = GENİŞLİK = WIDTH / T = KALINLIK = THICKNESS



ARTIM METAL ELEKTRİK A.Ş.

H AKM100 T

Yükseklik Kanal Tipi Genişlik Modül
Height Type Width Module

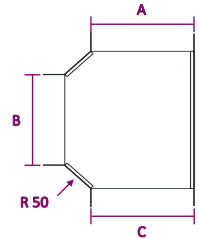
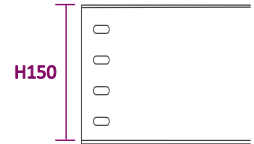
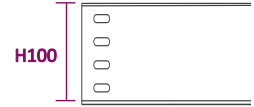
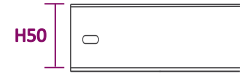

Dönüşlerde "A-B-C" ölçüleri esit olarak üretilmektedir. İsteğe bağlı olarak farklı ölçülerde üretim yapılır. Bends are produced same dimension for "A-B-C" as well as we can produce special dimensions regarding your inquiry.

* Farklı kalınlık ve ölçülerde üretim yapılabılır.
* Malzeme ağırlıkları yaklaşık değerlerdir, ± %10 değişiklik gösterebilir.
* Malzeme kalınlık toleransı ± %10 dur.
* Lütfen siparişlerinizde sipariş kodu veya ürün kodu ve Kaplama şeklini belirtiniz.

* We can produce cable trays different thickness and dimensions
* Cable trays are shown approximately weight, they could change ± %10 difference.
* Cable trays thickness tolerances are shown ± %10 .
* Please indicate order code and coating type in your orders.

AKM SERIES

T BAGLANTI R300

T BEND R300

SICAK DALDIRMA (SD)

HOT DIP GALVANIZED (HDG)

TS EN ISO 1461



H40 = Tek delikli
H40 = One hole

H60 = İki delikli
H60 = Two holes

H100 = H150 = Dört delikli
H100 = H150 = Four holes

H40

Sipariş Kodu Order Code	W (mm)	T1/T2 (mm)	Ağırlık (kg/ad) Weight (kg/pcs)	Barkod Kodu Barcode Code
40 AKM 100T	100	1.50 mm	2,188	2002200
40 AKM 200T	200	1.50 mm	2,552	2002201
40 AKM 300T	300	1.50 mm	3,209	2002202
40 AKM 400T	400	2.00 mm	4,751	2002203
40 AKM 500T	500	2.00 mm	5,303	2002204
40 AKM 600T	600	2.00 mm	5,855	2002205

H60

Sipariş Kodu Order Code	W (mm)	T1/T2 (mm)	Ağırlık (kg/ad) Weight (kg/pcs)	Barkod Kodu Barcode Code
60 AKM 100T	100	1.50 mm	2,760	2002216
60 AKM 200T	200	1.50 mm	3,213	2002217
60 AKM 300T	300	1.50 mm	3,672	2002218
60 AKM 400T	400	2.00 mm	5,377	2002219
60 AKM 500T	500	2.00 mm	5,958	2002220
60 AKM 600T	600	2.00 mm	6,536	2002221
60 AKM 700T	700	2.00 mm	7,117	2002222
60 AKM 800T	800	2.00 mm	7,693	2002223
60 AKM 900T	900	2.00 mm	8,275	2002224
60 AKM 1000T	1.000	2.00 mm	8,852	2002225

H100

Sipariş Kodu Order Code	W (mm)	T1/T2 (mm)	Ağırlık (kg/ad) Weight (kg/pcs)	Barkod Kodu Barcode Code
100 AKM 100T	100	1.50 mm	3,896	2002236
100 AKM 200T	200	1.50 mm	4,701	2002237
100 AKM 300T	300	1.50 mm	5,512	2002238
100 AKM 400T	400	2.00 mm	7,447	2002239
100 AKM 500T	500	2.00 mm	9,365	2002240
100 AKM 600T	600	2.00 mm	9,164	2002241
100 AKM 700T	700	2.00 mm	10,022	2002242
100 AKM 800T	800	2.00 mm	10,881	2002243
100 AKM 900T	900	2.00 mm	11,745	2002244
100 AKM 1000T	1.000	2.00 mm	12,603	2002245

H150

Sipariş Kodu Order Code	W (mm)	T1/T2 (mm)	Ağırlık (kg/ad) Weight (kg/pcs)	Barkod Kodu Barcode Code
150 AKM 200T	200	1.50 mm	5,671	2002246
150 AKM 300T	300	1.50 mm	6,535	2002247
150 AKM 400T	400	2.00 mm	8,883	2002248
150 AKM 500T	500	2.00 mm	9,821	2002249
150 AKM 600T	600	2.00 mm	10,754	2002250
150 AKM 700T	700	2.00 mm	11,687	2002251
150 AKM 800T	800	2.00 mm	12,625	2002252
150 AKM 900T	900	2.00 mm	13,663	2002253
150 AKM 1000T	1.000	2.00 mm	14,490	2002254

H = YÜKSEKLİK = HEIGHT / W = GENİŞLİK = WIDTH / T = KALINLIK = THICKNESS

H AKM100 T

Yükseklik Kanal Tipi Genişlik Modül
Height Type Width Module

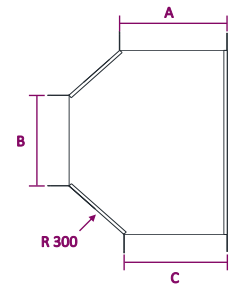
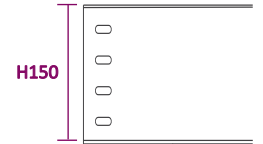
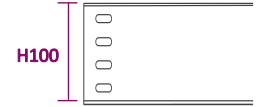
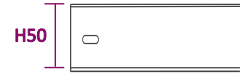

* Farklı kalınlık ve ölçülerde üretim yapıla bilinir.
* Malzeme ağırlıkları yaklaşık değerlerdir, ± %10 değişiklik gösterebilir.
* Malzeme kalınlık toleransı ± %10 dur.
* Lütfen siparişlerinizde sipariş kodu veya ürün kodu ve Kaplama şeklini belirtiniz.

* We can produce cable trays different thickness and dimensions
* Cable trays are shown approximately weight, they could change ± %10 difference.
* Cable trays thickness tolerances are shown ± %10 .
* Please indicate order code and coating type in your orders.

AKM SERIES

T BAGLANTI R450

T BEND R450

SICAK DALDIRMA (SD)
HOT DIP GALVANIZED (HDG)
TS EN ISO 1461



H40 = Tek delikli
H40 = One hole

H60 = İki delikli
H60 = Two holes

H100 = H150 = Dört delikli
H100 = H150 = Four holes

H40

Sipariş Kodu Order Code	W (mm)	T1/T2 (mm)	Ağırlık (kg/ad) Weight (kg/pcs)	Barkod Kodu Barcode Code
40 AKM 100T	100	1.50 mm	2,407	2002200
40 AKM 200T	200	1.50 mm	2,808	2002201
40 AKM 300T	300	1.50 mm	3,529	2002202
40 AKM 400T	400	2.00 mm	5,226	2002203
40 AKM 500T	500	2.00 mm	5,833	2002204
40 AKM 600T	600	2.00 mm	6,441	2002205

H60

Sipariş Kodu Order Code	W (mm)	T1/T2 (mm)	Ağırlık (kg/ad) Weight (kg/pcs)	Barkod Kodu Barcode Code
60 AKM 100T	100	1.50 mm	3,036	2002216
60 AKM 200T	200	1.50 mm	3,534	2002217
60 AKM 300T	300	1.50 mm	4,039	2002218
60 AKM 400T	400	2.00 mm	5,915	2002219
60 AKM 500T	500	2.00 mm	6,554	2002220
60 AKM 600T	600	2.00 mm	7,190	2002221
60 AKM 700T	700	2.00 mm	7,829	2002222
60 AKM 800T	800	2.00 mm	8,463	2002223
60 AKM 900T	900	2.00 mm	9,103	2002224
60 AKM 1000T	1.000	2.00 mm	9,737	2002225

H100

Sipariş Kodu Order Code	W (mm)	T1/T2 (mm)	Ağırlık (kg/ad) Weight (kg/pcs)	Barkod Kodu Barcode Code
100 AKM 100T	100	1.50 mm	4,285	2002236
100 AKM 200T	200	1.50 mm	5,171	2002237
100 AKM 300T	300	1.50 mm	6,063	2002238
100 AKM 400T	400	2.00 mm	8,191	2002239
100 AKM 500T	500	2.00 mm	10,302	2002240
100 AKM 600T	600	2.00 mm	10,080	2002241
100 AKM 700T	700	2.00 mm	11,025	2002242
100 AKM 800T	800	2.00 mm	11,969	2002243
100 AKM 900T	900	2.00 mm	12,919	2002244
100 AKM 1000T	1.000	2.00 mm	13,864	2002245

H150

Sipariş Kodu Order Code	W (mm)	T1/T2 (mm)	Ağırlık (kg/ad) Weight (kg/pcs)	Barkod Kodu Barcode Code
150 AKM 200T	200	1.50 mm	6,238	2002246
150 AKM 300T	300	1.50 mm	7,188	2002247
150 AKM 400T	400	2.00 mm	9,771	2002248
150 AKM 500T	500	2.00 mm	10,803	2002249
150 AKM 600T	600	2.00 mm	11,829	2002250
150 AKM 700T	700	2.00 mm	12,855	2002251
150 AKM 800T	800	2.00 mm	13,887	2002252
150 AKM 900T	900	2.00 mm	15,030	2002253
150 AKM 1000T	1.000	2.00 mm	15,939	2002254

H = YÜKSEKLİK = HEIGHT / W = GENİŞLİK = WIDTH / T = KALINLIK = THICKNESS

H AKM100 T

Yükseklik Kanal Tipi Genişlik Modül
Height Type Width Module

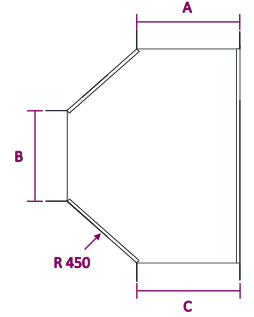
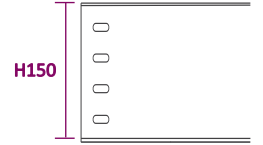
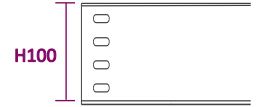
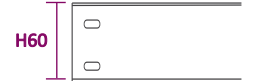
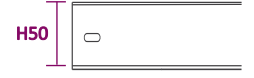

ARTIM METAL ELEKTRİK A.Ş.

* Farklı kalınlık ve ölçülerde üretim yapılabılır.
* Malzeme ağırlıkları yaklaşık değerlerdir, ± %10 değişiklik gösterebilir.
* Malzeme kalınlık toleransı ± %10 dur.
* Lütfen siparişlerinizde sipariş kodu veya ürün kodu ve Kaplama şeklini belirtiniz.

* We can produce cable trays different thickness and dimensions
* Cable trays are shown approximately weight, they could change ± %10 difference.
* Cable trays thickness tolerances are shown ± %10 .
* Please indicate order code and coating type in your orders.

AKM SERIES

T BAGLANTI R600

T BEND R600

SICAK DALDIRMA (SD)

HOT DIP GALVANIZED (HDG)

TS EN ISO 1461



H40 = Tek delikli
H40 = One hole

H60 = İki delikli
H60 = Two holes

H100 = H150 = Dört delikli
H100 = H150 = Four holes

H40

Sipariş Kodu Order Code	W (mm)	T1/T2 (mm)	Ağırlık (kg/ad) Weight (kg/pcs)	Barkod Kodu Barcode Code
40 AKM 100T	100	1.50 mm	2,647	2002200
40 AKM 200T	200	1.50 mm	3,089	2002201
40 AKM 300T	300	1.50 mm	3,882	2002202
40 AKM 400T	400	2.00 mm	5,749	2002203
40 AKM 500T	500	2.00 mm	6,417	2002204
40 AKM 600T	600	2.00 mm	7,085	2002205

H60

Sipariş Kodu Order Code	W (mm)	T1/T2 (mm)	Ağırlık (kg/ad) Weight (kg/pcs)	Barkod Kodu Barcode Code
60 AKM 100T	100	1.50 mm	3,340	2002216
60 AKM 200T	200	1.50 mm	3,888	2002217
60 AKM 300T	300	1.50 mm	4,443	2002218
60 AKM 400T	400	2.00 mm	6,507	2002219
60 AKM 500T	500	2.00 mm	7,209	2002220
60 AKM 600T	600	2.00 mm	7,909	2002221
60 AKM 700T	700	2.00 mm	8,611	2002222
60 AKM 800T	800	2.00 mm	9,309	2002223
60 AKM 900T	900	2.00 mm	10,013	2002224
60 AKM 1000T	1.000	2.00 mm	10,711	2002225

H100

Sipariş Kodu Order Code	W (mm)	T1/T2 (mm)	Ağırlık (kg/ad) Weight (kg/pcs)	Barkod Kodu Barcode Code
100 AKM 100T	100	1.50 mm	4,714	2002236
100 AKM 200T	200	1.50 mm	5,688	2002237
100 AKM 300T	300	1.50 mm	6,670	2002238
100 AKM 400T	400	2.00 mm	9,010	2002239
100 AKM 500T	500	2.00 mm	11,332	2002240
100 AKM 600T	600	2.00 mm	11,088	2002241
100 AKM 700T	700	2.00 mm	12,127	2002242
100 AKM 800T	800	2.00 mm	13,166	2002243
100 AKM 900T	900	2.00 mm	14,211	2002244
100 AKM 1000T	1.000	2.00 mm	15,250	2002245

H150

Sipariş Kodu Order Code	W (mm)	T1/T2 (mm)	Ağırlık (kg/ad) Weight (kg/pcs)	Barkod Kodu Barcode Code
150 AKM 200T	200	1.50 mm	6,862	2002246
150 AKM 300T	300	1.50 mm	7,907	2002247
150 AKM 400T	400	2.00 mm	10,748	2002248
150 AKM 500T	500	2.00 mm	11,883	2002249
150 AKM 600T	600	2.00 mm	13,012	2002250
150 AKM 700T	700	2.00 mm	14,141	2002251
150 AKM 800T	800	2.00 mm	15,276	2002252
150 AKM 900T	900	2.00 mm	16,533	2002253
150 AKM 1000T	1.000	2.00 mm	17,533	2002254

H = YÜKSEKLİK = HEIGHT / W = GENİŞLİK = WIDTH / T = KALINLIK = THICKNESS

H AKM100 T

Yükseklik Kanal Tipi Genişlik Modül
Height Type Width Module

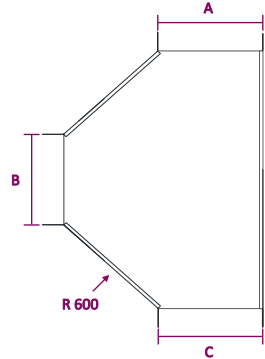
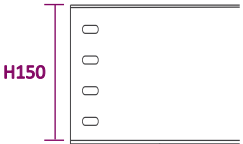
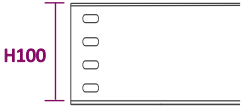
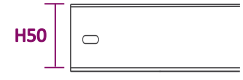

* Farklı kalınlık ve ölçülerde üretim yapıla bilinir.
* Malzeme ağırlıkları yaklaşık değerlerdir, ± %10 değişiklik gösterebilir.
* Malzeme kalınlık toleransı ± %10 dur.
* Lütfen siparişinizde sipariş kodu veya ürün kodu ve Kaplama şeklini belirtiniz.

* We can produce cable trays different thickness and dimensions
* Cable trays are shown approximately weight, they could change ± %10 difference.
* Cable trays thickness tolerances are shown ± %10 .
* Please indicate order code and coating type in your orders.

AKM SERIES

DÖRTLÜ BAGLANTI

FOUR WAY CROSSING

SICAK DALDIRMA (SD)
HOT DIP GALVANIZED (HDG)
TS EN ISO 1461



H40 = Tek delikli
H40 = One hole

H60 = İki delikli
H60 = Two holes

H100 = H150 = Dört delikli
H100 = H150 = Four holes

H40

Sipariş Kodu Order Code	W (mm)	T1/T2 (mm)	Ağırlık (kg/ad) Weight (kg/pcs)	Barkod Kodu Barcode Code
40 AKM 100D	100	1.50 mm	2,595	2002300
40 AKM 200D	200	1.50 mm	2,910	2002301
40 AKM 300D	300	1.50 mm	3,589	2002302
40 AKM 400D	400	2.00 mm	5,138	2002303
40 AKM 500D	500	2.00 mm	5,607	2002304
40 AKM 600D	600	2.00 mm	6,082	2002305

H60

Sipariş Kodu Order Code	W (mm)	T1/T2 (mm)	Ağırlık (kg/ad) Weight (kg/pcs)	Barkod Kodu Barcode Code
60 AKM 100D	100	1.50 mm	3,310	2002316
60 AKM 200D	200	1.50 mm	3,692	2002317
60 AKM 300D	300	1.50 mm	4,068	2002318
60 AKM 400D	400	2.00 mm	5,775	2002319
60 AKM 500D	500	2.00 mm	6,249	2002320
60 AKM 600D	600	2.00 mm	6,723	2002321
60 AKM 700D	700	2.00 mm	7,965	2002322
60 AKM 800D	800	2.00 mm	8,518	2002323
60 AKM 900D	900	2.00 mm	9,072	2002324
60 AKM 1000D	1.000	2.00 mm	9,625	2002325

H100

Sipariş Kodu Order Code	W (mm)	T1/T2 (mm)	Ağırlık (kg/ad) Weight (kg/pcs)	Barkod Kodu Barcode Code
100 AKM 100D	100	1.50 mm	4,745	2002336
100 AKM 200D	200	1.50 mm	5,485	2002337
100 AKM 300D	300	1.50 mm	6,225	2002338
100 AKM 400D	400	2.00 mm	8,080	2002339
100 AKM 500D	500	2.00 mm	8,815	2002340
100 AKM 600D	600	2.00 mm	9,555	2002341
100 AKM 700D	700	2.00 mm	11,495	2002342
100 AKM 800D	800	2.00 mm	12,355	2002343
100 AKM 900D	900	2.00 mm	13,220	2002344
100 AKM 1000D	1.000	2.00 mm	14,080	2002345

H150

Sipariş Kodu Order Code	W (mm)	T1/T2 (mm)	Ağırlık (kg/ad) Weight (kg/pcs)	Barkod Kodu Barcode Code
150 AKM 200D	200	1.50 mm	6,435	2002346
150 AKM 300D	300	1.50 mm	7,175	2002347
150 AKM 400D	400	2.00 mm	9,345	2002348
150 AKM 500D	500	2.00 mm	10,085	2002349
150 AKM 600D	600	2.00 mm	10,821	2002350
150 AKM 700D	700	2.00 mm	12,765	2002351
150 AKM 800D	800	2.00 mm	13,625	2002352
150 AKM 900D	900	2.00 mm	14,485	2002353
150 AKM 1000D	1.000	2.00 mm	15,345	2002354

H = YÜKSEKLİK = HEIGHT / W = GENİŞLİK = WIDTH / T = KALINLIK = THICKNESS

H AKM100 D

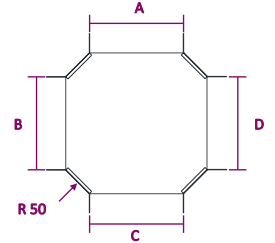
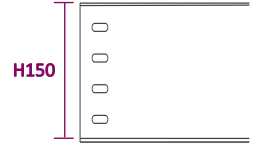
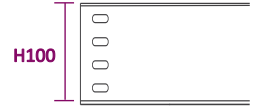
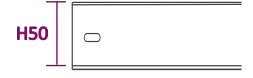

Dönüşlerde "A-B-C-D" ölçüleri eşit olarak üretilmektedir. İsteğe bağlı olarak farklı ölçülerde üretim yapılır. Bends are produced same dimension for "A-B-C-D" as well as we can produce special dimensions regarding your inquiry.

ARTIM METAL ELEKTRİK A.Ş.

* Farklı kalınlık ve ölçülerde üretim yapılabılır.
* Malzeme ağırlıkları yaklaşık değerlerdir, ± %10 değişiklik gösterebilir.
* Malzeme kalınlık toleransı ± %10 dur.
* Lütfen siparişlerinizde sipariş kodu veya ürün kodu ve Kaplama şeklini belirtiniz.

* We can produce cable trays different thickness and dimensions
* Cable trays are shown approximately weight, they could change ± %10 difference.
* Cable trays thickness tolerances are shown ± %10 .
* Please indicate order code and coating type in your orders.

AKM SERIES

DÖRTLÜ BAGLANTI R300

FOUR WAY CROSSING R300

SICAK DALDIRMA (SD)

HOT DIP GALVANIZED (HDG)

TS EN ISO 1461



H40 = Tek delikli
H40 = One hole

H60 = İki delikli
H60 = Two holes

H100 = H150 = Dört delikli
H100 = H150 = Four holes

H40

Sipariş Kodu Order Code	W (mm)	T1/T2 (mm)	Ağırlık (kg/ad) Weight (kg/pcs)	Barkod Kodu Barcode Code
40 AKM 100D	100	1.50 mm	2,751	2002300
40 AKM 200D	200	1.50 mm	3,085	2002301
40 AKM 300D	300	1.50 mm	3,804	2002302
40 AKM 400D	400	2.00 mm	5,446	2002303
40 AKM 500D	500	2.00 mm	5,943	2002304
40 AKM 600D	600	2.00 mm	6,447	2002305

H60

Sipariş Kodu Order Code	W (mm)	T1/T2 (mm)	Ağırlık (kg/ad) Weight (kg/pcs)	Barkod Kodu Barcode Code
60 AKM 100D	100	1.50 mm	3,509	2002316
60 AKM 200D	200	1.50 mm	3,914	2002317
60 AKM 300D	300	1.50 mm	4,312	2002318
60 AKM 400D	400	2.00 mm	6,122	2002319
60 AKM 500D	500	2.00 mm	6,624	2002320
60 AKM 600D	600	2.00 mm	7,126	2002321
60 AKM 700D	700	2.00 mm	8,443	2002322
60 AKM 800D	800	2.00 mm	9,029	2002323
60 AKM 900D	900	2.00 mm	9,616	2002324
60 AKM 1000D	1.000	2.00 mm	10,203	2002325

H100

Sipariş Kodu Order Code	W (mm)	T1/T2 (mm)	Ağırlık (kg/ad) Weight (kg/pcs)	Barkod Kodu Barcode Code
100 AKM 100D	100	1.50 mm	5,030	2002336
100 AKM 200D	200	1.50 mm	5,814	2002337
100 AKM 300D	300	1.50 mm	6,599	2002338
100 AKM 400D	400	2.00 mm	8,565	2002339
100 AKM 500D	500	2.00 mm	9,344	2002340
100 AKM 600D	600	2.00 mm	10,128	2002341
100 AKM 700D	700	2.00 mm	12,185	2002342
100 AKM 800D	800	2.00 mm	13,096	2002343
100 AKM 900D	900	2.00 mm	14,013	2002344
100 AKM 1000D	1.000	2.00 mm	14,925	2002345

H150

Sipariş Kodu Order Code	W (mm)	T1/T2 (mm)	Ağırlık (kg/ad) Weight (kg/pcs)	Barkod Kodu Barcode Code
150 AKM 200D	200	1.50 mm	6,821	2002346
150 AKM 300D	300	1.50 mm	7,606	2002347
150 AKM 400D	400	2.00 mm	9,906	2002348
150 AKM 500D	500	2.00 mm	10,690	2002349
150 AKM 600D	600	2.00 mm	11,470	2002350
150 AKM 700D	700	2.00 mm	13,531	2002351
150 AKM 800D	800	2.00 mm	14,443	2002352
150 AKM 900D	900	2.00 mm	15,354	2002353
150 AKM 1000D	1.000	2.00 mm	16,266	2002354

H = YÜKSEKLİK = HEIGHT / W = GENİŞLİK = WIDTH / T = KALINLIK = THICKNESS

H AKM100 D

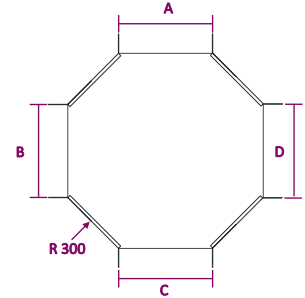
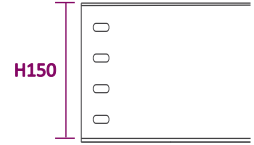
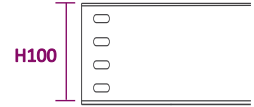
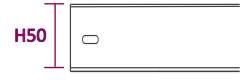

* Farklı kalınlık ve ölçülerde üretim yapılabılır.
* Malzeme ağırlıkları yaklaşık değerlerdir, ± %10 değişiklik gösterebilir.
* Malzeme kalınlık toleransı ± %10 dur.
* Lütfen siparişlerinizde sipariş kodu veya ürün kodu ve Kaplama şeklini belirtiniz.

* We can produce cable trays different thickness and dimensions
* Cable trays are shown approximately weight, they could change ± %10 difference.
* Cable trays thickness tolerances are shown ± %10 .
* Please indicate order code and coating type in your orders.

AKM SERIES

DÖRTLÜ BAGLANTI R450

FOUR WAY CROSSING R450

SICAK DALDIRMA (SD)
HOT DIP GALVANIZED (HDG)
TS EN ISO 1461



H40 = Tek delikli
H40 = One hole

H60 = İki delikli
H60 = Two holes

H100 = H150 = Dört delikli
H100 = H150 = Four holes

H40

Sipariş Kodu Order Code	W (mm)	T1/T2 (mm)	Ağırlık (kg/ad) Weight (kg/pcs)	Barkod Kodu Barcode Code
40 AKM 100D	100	1.50 mm	3,026	2002300
40 AKM 200D	200	1.50 mm	3,393	2002301
40 AKM 300D	300	1.50 mm	4,185	2002302
40 AKM 400D	400	2.00 mm	5,991	2002303
40 AKM 500D	500	2.00 mm	6,538	2002304
40 AKM 600D	600	2.00 mm	7,092	2002305

H60

Sipariş Kodu Order Code	W (mm)	T1/T2 (mm)	Ağırlık (kg/ad) Weight (kg/pcs)	Barkod Kodu Barcode Code
60 AKM 100D	100	1.50 mm	3,859	2002316
60 AKM 200D	200	1.50 mm	4,305	2002317
60 AKM 300D	300	1.50 mm	4,743	2002318
60 AKM 400D	400	2.00 mm	6,734	2002319
60 AKM 500D	500	2.00 mm	7,286	2002320
60 AKM 600D	600	2.00 mm	7,839	2002321
60 AKM 700D	700	2.00 mm	9,287	2002322
60 AKM 800D	800	2.00 mm	9,932	2002323
60 AKM 900D	900	2.00 mm	10,578	2002324
60 AKM 1000D	1.000	2.00 mm	11,223	2002325

H100

Sipariş Kodu Order Code	W (mm)	T1/T2 (mm)	Ağırlık (kg/ad) Weight (kg/pcs)	Barkod Kodu Barcode Code
100 AKM 100D	100	1.50 mm	5,533	2002336
100 AKM 200D	200	1.50 mm	6,396	2002337
100 AKM 300D	300	1.50 mm	7,258	2002338
100 AKM 400D	400	2.00 mm	9,421	2002339
100 AKM 500D	500	2.00 mm	10,278	2002340
100 AKM 600D	600	2.00 mm	11,141	2002341
100 AKM 700D	700	2.00 mm	13,403	2002342
100 AKM 800D	800	2.00 mm	14,406	2002343
100 AKM 900D	900	2.00 mm	15,415	2002344
100 AKM 1000D	1.000	2.00 mm	16,417	2002345

H150

Sipariş Kodu Order Code	W (mm)	T1/T2 (mm)	Ağırlık (kg/ad) Weight (kg/pcs)	Barkod Kodu Barcode Code
150 AKM 200D	200	1.50 mm	7,503	2002346
150 AKM 300D	300	1.50 mm	8,366	2002347
150 AKM 400D	400	2.00 mm	10,896	2002348
150 AKM 500D	500	2.00 mm	11,759	2002349
150 AKM 600D	600	2.00 mm	12,617	2002350
150 AKM 700D	700	2.00 mm	14,884	2002351
150 AKM 800D	800	2.00 mm	15,887	2002352
150 AKM 900D	900	2.00 mm	16,890	2002353
150 AKM 1000D	1.000	2.00 mm	17,892	2002354

H = YÜKSEKLİK = HEIGHT / W = GENİŞLİK = WIDTH / T = KALINLIK = THICKNESS

H AKM100 D

Yükseklik | Kanal Tipi | Genişlik | Modül
Height | Type | Width | Module

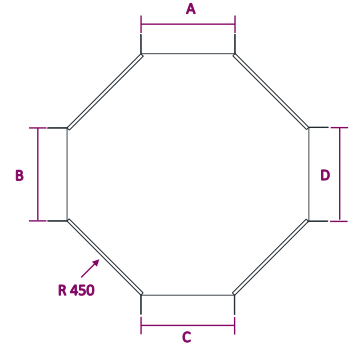
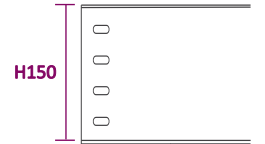
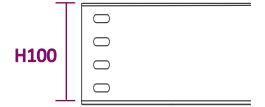
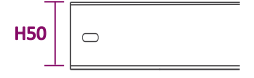

ARTIM METAL ELEKTRİK A.Ş.

* Farklı kalınlık ve ölçülerde üretim yapılabılır.
* Malzeme ağırlıkları yaklaşık değerlerdir, ± %10 değişiklik gösterebilir.
* Malzeme kalınlık toleransı ± %10 dur.
* Lütfen siparişlerinizde sipariş kodu veya ürün kodu ve Kaplama şeklini belirtiniz.

* We can produce cable trays different thickness and dimensions
* Cable trays are shown approximately weight, they could change ± %10 difference.
* Cable trays thickness tolerances are shown ± %10 .
* Please indicate order code and coating type in your orders.

AKM SERIES

DÖRTLÜ BAGLANTI R600

FOUR WAY CROSSING R600

SICAK DALDIRMA (SD)

HOT DIP GALVANIZED (HDG)

TS EN ISO 1461



H40 = Tek delikli

H40 = One hole

H60 = İki delikli

H60 = Two holes

H100 = H150 = Dört delikli

H100 = H150 = Four holes

H40

Sipariş Kodu Order Code	W (mm)	T1/T2 (mm)	Ağırlık (kg/ad) Weight (kg/pcs)	Barkod Kodu Barcode Code
40 AKM 100D	100	1.50 mm	3,328	2002300
40 AKM 200D	200	1.50 mm	3,732	2002301
40 AKM 300D	300	1.50 mm	4,603	2002302
40 AKM 400D	400	2.00 mm	6,590	2002303
40 AKM 500D	500	2.00 mm	7,192	2002304
40 AKM 600D	600	2.00 mm	7,801	2002305

H60

Sipariş Kodu Order Code	W (mm)	T1/T2 (mm)	Ağırlık (kg/ad) Weight (kg/pcs)	Barkod Kodu Barcode Code
60 AKM 100D	100	1.50 mm	4,245	2002316
60 AKM 200D	200	1.50 mm	4,735	2002317
60 AKM 300D	300	1.50 mm	5,218	2002318
60 AKM 400D	400	2.00 mm	7,407	2002319
60 AKM 500D	500	2.00 mm	8,015	2002320
60 AKM 600D	600	2.00 mm	8,623	2002321
60 AKM 700D	700	2.00 mm	10,216	2002322
60 AKM 800D	800	2.00 mm	10,925	2002323
60 AKM 900D	900	2.00 mm	11,636	2002324
60 AKM 1000D	1.000	2.00 mm	12,345	2002325

H100

Sipariş Kodu Order Code	W (mm)	T1/T2 (mm)	Ağırlık (kg/ad) Weight (kg/pcs)	Barkod Kodu Barcode Code
100 AKM 100D	100	1.50 mm	6,086	2002336
100 AKM 200D	200	1.50 mm	7,035	2002337
100 AKM 300D	300	1.50 mm	7,984	2002338
100 AKM 400D	400	2.00 mm	10,363	2002339
100 AKM 500D	500	2.00 mm	11,306	2002340
100 AKM 600D	600	2.00 mm	12,255	2002341
100 AKM 700D	700	2.00 mm	14,743	2002342
100 AKM 800D	800	2.00 mm	15,847	2002343
100 AKM 900D	900	2.00 mm	16,956	2002344
100 AKM 1000D	1.000	2.00 mm	18,059	2002345

H150

Sipariş Kodu Order Code	W (mm)	T1/T2 (mm)	Ağırlık (kg/ad) Weight (kg/pcs)	Barkod Kodu Barcode Code
150 AKM 200D	200	1.50 mm	8,254	2002346
150 AKM 300D	300	1.50 mm	9,203	2002347
150 AKM 400D	400	2.00 mm	11,986	2002348
150 AKM 500D	500	2.00 mm	12,935	2002349
150 AKM 600D	600	2.00 mm	13,879	2002350
150 AKM 700D	700	2.00 mm	16,372	2002351
150 AKM 800D	800	2.00 mm	17,475	2002352
150 AKM 900D	900	2.00 mm	18,578	2002353
150 AKM 1000D	1.000	2.00 mm	19,681	2002354

H = YÜKSEKLİK = HEIGHT / W = GENİŞLİK = WIDTH / T = KALINLIK = THICKNESS

H AKM100 D

Yükseklik Kanal Tipi Genişlik Modül
Height Type Width Module

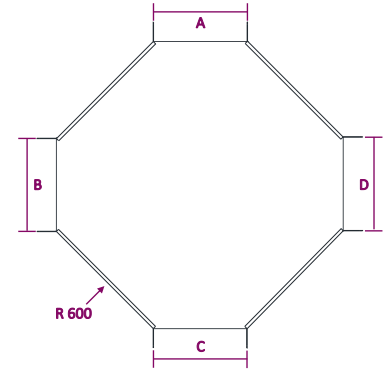
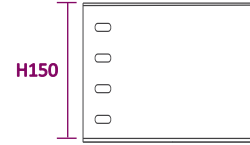
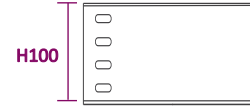
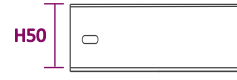

* Farklı kalınlık ve ölçülerde üretim yapılabılır.
* Malzeme ağırlıkları yaklaşık değerlerdir, \pm %10 değişiklik gösterebilir.
* Malzeme kalınlık toleransı \pm %10 dur.
* Lütfen siparişlerinizde sipariş kodu veya ürün kodu ve kaplama şeklini belirtiniz.

* We can produce cable trays different thickness and dimensions
* Cable trays are shown approximately weight, they could change \pm %10 difference.
* Cable trays thickness tolerances are shown \pm %10 .
* Please indicate order code and coating type in your orders.

AKM SERIES

45° YATAY DÖNÜS

45° BEND

SICAK DALDIRMA (SD)
HOT DIP GALVANIZED (HDG)
TS EN ISO 1461



H40 = Tek delikli
H40 = One hole

H60 = İki delikli
H60 = Two holes

H100 = H150 = Dört delikli
H100 = H150 = Four holes

H40

Sipariş Kodu Order Code	W (mm)	T1/T2 (mm)	Ağırlık (kg/ad) Weight (kg/pcs)	Barkod Kodu Barcode Code
40 AKM 100Y (45°)	100	1.50 mm	1,093	2002160
40 AKM 200Y (45°)	200	1.50 mm	1,232	2002161
40 AKM 300Y (45°)	300	1.50 mm	1,445	2002162
40 AKM 400Y (45°)	400	2.00 mm	2,146	2002163
40 AKM 500Y (45°)	500	2.00 mm	2,347	2002164
40 AKM 600Y (45°)	600	2.00 mm	2,548	2002165

H60

Sipariş Kodu Order Code	W (mm)	T1/T2 (mm)	Ağırlık (kg/ad) Weight (kg/pcs)	Barkod Kodu Barcode Code
60 AKM 100Y (45°)	100	1.50 mm	1,381	2002166
60 AKM 200Y (45°)	200	1.50 mm	1,543	2002167
60 AKM 300Y (45°)	300	1.50 mm	1,706	2002168
60 AKM 400Y (45°)	400	2.00 mm	2,511	2002169
60 AKM 500Y (45°)	500	2.00 mm	2,729	2002170
60 AKM 600Y (45°)	600	2.00 mm	2,948	2002171

H100

Sipariş Kodu Order Code	W (mm)	T1/T2 (mm)	Ağırlık (kg/ad) Weight (kg/pcs)	Barkod Kodu Barcode Code
100 AKM 100Y (45°)	100	1.50 mm	1,875	2002172
100 AKM 200Y (45°)	200	1.50 mm	2,110	2002173
100 AKM 300Y (45°)	300	1.50 mm	2,340	2002174
100 AKM 400Y (45°)	400	2.00 mm	3,450	2002175
100 AKM 500Y (45°)	500	2.00 mm	3,765	2002176
100 AKM 600Y (45°)	600	2.00 mm	4,075	2002177

H150

Sipariş Kodu Order Code	W (mm)	T1/T2 (mm)	Ağırlık (kg/ad) Weight (kg/pcs)	Barkod Kodu Barcode Code
150 AKM 200Y (45°)	200	1.50 mm	2,925	2002178
150 AKM 300Y (45°)	300	1.50 mm	3,240	2002179
150 AKM 400Y (45°)	400	2.00 mm	4,585	2002180
150 AKM 500Y (45°)	500	2.00 mm	4,965	2002181
150 AKM 600Y (45°)	600	2.00 mm	5,350	2002182

H = YÜKSEKLİK = HEIGHT / W = GENİŞLİK = WIDTH / T = KALINLIK = THICKNESS

H AKM100 Y (45°)

Yükseklik Kanal Tipi Genişlik Modül
Height Type Width Module

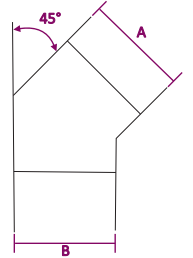
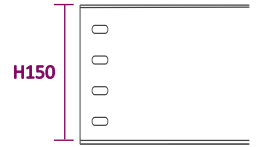
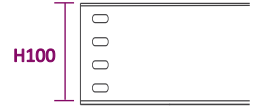
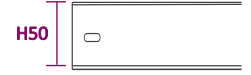

ARTIM METAL ELEKTRİK A.Ş.

* Farklı kalınlık ve ölçülerde üretim yapılabılır.
* Malzeme ağırlıkları yaklaşık değerlerdir, ± %10 değişiklik gösterebilir.
* Malzeme kalınlık toleransı ± %10 dur.
* Lütfen siparişlerinizde sipariş kodu veya ürün kodu ve Kaplama şeklini belirtiniz.

* We can produce cable trays different thickness and dimensions
* Cable trays are shown approximately weight, they could change ± %10 difference.
* Cable trays thickness tolerances are shown ± %10 .
* Please indicate order code and coating type in your orders.

AKM SERIES

REDÜKSİYON (PARÇALI)

REDUCING ANGLES (PIECE)

SICAK DALDIRMA (SD)

HOT DIP GALVANIZED (HDG)

TS EN ISO 1461



H40

Sipariş Kodu Order Code	W (mm)	T (mm)	Ağırlık (kg/ad) Weight (kg/pcs)	Barkod Kodu Barcode Code
40 AGH 050R	50	1.50 mm	0,195	2001400
40 AGH 100R	100	1.50 mm	0,240	2001401
40 AGH 150R	150	1.50 mm	0,275	2001402
40 AGH 200R	200	1.50 mm	0,315	2001403
40 AGH 300R	300	1.50 mm	0,395	2001404

H60

Sipariş Kodu Order Code	W (mm)	T (mm)	Ağırlık (kg/ad) Weight (kg/pcs)	Barkod Kodu Barcode Code
60 AGH 050R	50	1.50 mm	0,260	2001410
60 AGH 100R	100	1.50 mm	0,315	2001411
60 AGH 150R	150	1.50 mm	0,370	2001412
60 AGH 200R	200	1.50 mm	0,420	2001413
60 AGH 300R	300	1.50 mm	0,525	2001414

H100

Sipariş Kodu Order Code	W (mm)	T (mm)	Ağırlık (kg/ad) Weight (kg/pcs)	Barkod Kodu Barcode Code
100 AGH 050R	50	1.50 mm	0,380	2001415
100 AGH 100R	100	1.50 mm	0,465	2001416
100 AGH 150R	150	1.50 mm	0,540	2001417
100 AGH 200R	200	1.50 mm	0,625	2001418
100 AGH 300R	300	1.50 mm	0,785	2001419

H = YÜKSEKLİK = HEIGHT / W = GENİŞLİK = WIDTH / T = KALINLIK = THICKNESS

H AGH 100 R

Yükseklik Height	Kanal Tipi Type	Genişlik Width	Modül Module
---------------------	--------------------	-------------------	-----------------

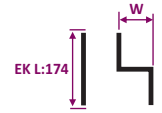

SOLA / LEFT

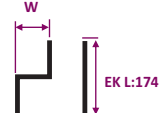

SAĞA / RIGHT

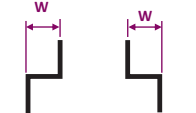

ORTADAN / FROM MIDDLE



Ürün tek olarak satılmaktadır.
The product is sold single.

* Farklı kalınlık ve ölçülerde üretim yapılabilmektedir.
* Malzeme ağırlıkları yaklaşık değerlerdir, \pm %10 değişiklik gösterebilir.
* Malzeme kalınlık toleransı \pm %10 dur.
* Lütfen siparişlerinizde sipariş kodu veya ürün kodu ve kaplama şeklini belirtiniz.

* We can produce cable trays different thickness and dimensions
* Cable trays are shown approximately weight, they could change \pm %10 difference.
* Cable trays thickness tolerances are shown \pm %10 .
* Please indicate order code and coating type in your orders.

AKM SERIES

MERDIVEN SEVIYE DEĞİSTİRME

LEVEL CHANGE UNITS

SICAK DALDIRMA (SD)
HOT DIP GALVANIZED (HDG)
TS EN ISO 1461



H40 = Tek delikli
H40 = One hole

H60 = İki delikli
H60 = Two holes

H100 = H150 = Dört delikli
H100 = H150 = Four holes



H40

Sipariş Kodu Order Code	W (mm)	T1/T2 (mm)	Ağırlık (kg/ad) Weight (kg/pcs)	Barkod Kodu Barcode Code
40 AKM 100S	100	1.50 mm	0,451	2002800
40 AKM 200S	200	1.50 mm	0,506	2002801
40 AKM 300S	300	1.50 mm	0,567	2002802
40 AKM 400S	400	2.00 mm	0,827	2002803
40 AKM 500S	500	2.00 mm	0,916	2002804
40 AKM 600S	600	2.00 mm	0,995	2002805

H60

Sipariş Kodu Order Code	W (mm)	T1/T2 (mm)	Ağırlık (kg/ad) Weight (kg/pcs)	Barkod Kodu Barcode Code
60 AKM 100S	100	1.50 mm	0,562	2002812
60 AKM 200S	200	1.50 mm	0,623	2002813
60 AKM 300S	300	1.50 mm	0,678	2002814
60 AKM 400S	400	2.00 mm	0,985	2002815
60 AKM 500S	500	2.00 mm	1,064	2002816
60 AKM 600S	600	2.00 mm	1,143	2002817

H100

Sipariş Kodu Order Code	W (mm)	T1/T2 (mm)	Ağırlık (kg/ad) Weight (kg/pcs)	Barkod Kodu Barcode Code
100 AKM 100S	100	1.50 mm	0,830	2002824
100 AKM 200S	200	1.50 mm	0,920	2002825
100 AKM 300S	300	1.50 mm	1,015	2002826
100 AKM 400S	400	2.00 mm	1,470	2002827
100 AKM 500S	500	2.00 mm	1,595	2002828
100 AKM 600S	600	2.00 mm	1,715	2002829

H150

Sipariş Kodu Order Code	W (mm)	T1/T2 (mm)	Ağırlık (kg/ad) Weight (kg/pcs)	Barkod Kodu Barcode Code
150 AKM 200S	200	1.50 mm	1,305	2002830
150 AKM 300S	300	1.50 mm	1,430	2002831
150 AKM 400S	400	2.00 mm	1,905	2002832
150 AKM 500S	500	2.00 mm	2,030	2002833
150 AKM 600S	600	2.00 mm	2,150	2002834

H = YÜKSEKLİK = HEIGHT / W = GENİŞLİK = WIDTH / T = KALINLIK = THICKNESS

H AKM100 S

Yükseklik Kanal Tipi Genişlik Modül
Height Type Width Module

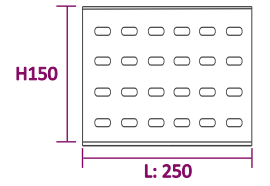
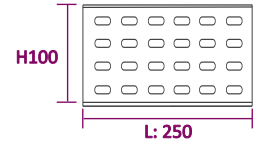
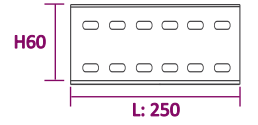
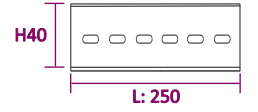

ARTIM METAL ELEKTRİK A.Ş.

* Farklı kalınlık ve ölçülerde üretim yapılabılır.
* Malzeme ağırlıkları yaklaşık değerlerdir, ± %10 değişiklik gösterebilir.
* Malzeme kalınlık toleransı ± %10 dur.
* Lütfen siparişlerinizde sipariş kodu veya ürün kodu ve Kaplama şeklini belirtiniz.

* We can produce cable trays different thickness and dimensions
* Cable trays are shown approximately weight, they could change ± %10 difference.
* Cable trays thickness tolerances are shown ± %10 .
* Please indicate order code and coating type in your orders.

AKM SERIES

İÇ-DİS BÜKEY DÖNÜS (HAREKETLİ)

ADJUSTABLE INSIDE-OUTSIDE VERTICAL BENDS

SICAK DALDIRMA (SD)

HOT DIP GALVANIZED (HDG)

TS EN ISO 1461



H40 = Tek delikli
H40 = One hole

H60 = İki delikli
H60 = Two holes

H100 = H150 = Dört delikli
H100 = H150 = Four holes

H40

Sipariş Kodu Order Code	W (mm)	T1/T2 (mm)	Ağırlık (kg/ad) Weight (kg/pcs)	Barkod Kodu Barcode Code
40 AKM 100B	100	1.50 mm	1,613	2002500
40 AKM 200B	200	1.50 mm	1,803	2002501
40 AKM 300B	300	1.50 mm	1,994	2002502
40 AKM 400B	400	2.00 mm	2,696	2002503
40 AKM 500B	500	2.00 mm	2,887	2002504
40 AKM 600B	600	2.00 mm	3,078	2002505

H60

Sipariş Kodu Order Code	W (mm)	T1/T2 (mm)	Ağırlık (kg/ad) Weight (kg/pcs)	Barkod Kodu Barcode Code
60 AKM 100B	100	1.50 mm	1,999	2002516
60 AKM 200B	200	1.50 mm	2,190	2002517
60 AKM 300B	300	1.50 mm	2,381	2002518
60 AKM 400B	400	2.00 mm	3,221	2002519
60 AKM 500B	500	2.00 mm	3,412	2002520
60 AKM 600B	600	2.00 mm	3,603	2002521
60 AKM 700B	700	2.00 mm	3,794	2002522
60 AKM 800B	800	2.00 mm	3,985	2002523
60 AKM 900B	900	2.00 mm	4,176	2002524
60 AKM 1000B	1.000	2.00 mm	4,366	2002525

H100

Sipariş Kodu Order Code	W (mm)	T1/T2 (mm)	Ağırlık (kg/ad) Weight (kg/pcs)	Barkod Kodu Barcode Code
100 AKM 100B	100	1.50 mm	2,796	2002536
100 AKM 200B	200	1.50 mm	3,051	2002537
100 AKM 300B	300	1.50 mm	3,306	2002538
100 AKM 400B	400	2.00 mm	4,474	2002539
100 AKM 500B	500	2.00 mm	4,729	2002540
100 AKM 600B	600	2.00 mm	4,984	2002541
100 AKM 700B	700	2.00 mm	5,240	2002542
100 AKM 800B	800	2.00 mm	5,495	2002543
100 AKM 900B	900	2.00 mm	5,750	2002544
100 AKM 1000B	1.000	2.00 mm	6,005	2002545

H150

Sipariş Kodu Order Code	W (mm)	T1/T2 (mm)	Ağırlık (kg/ad) Weight (kg/pcs)	Barkod Kodu Barcode Code
150 AKM 200B	200	1.50 mm	4,018	2002546
150 AKM 300B	300	1.50 mm	4,274	2002547
150 AKM 400B	400	2.00 mm	5,786	2002548
150 AKM 500B	500	2.00 mm	6,041	2002549
150 AKM 600B	600	2.00 mm	6,297	2002550
150 AKM 700B	700	2.00 mm	6,552	2002551
150 AKM 800B	800	2.00 mm	6,807	2002552
150 AKM 900B	900	2.00 mm	7,063	2002553
150 AKM 1000B	1.000	2.00 mm	7,318	2002554

H = YÜKSEKLİK = HEIGHT / W = GENİŞLİK = WIDTH / T = KALINLIK = THICKNESS

H AKM 100 B

Yükseklik Kanal Tipi Genişlik Modül
Height Type Width Module

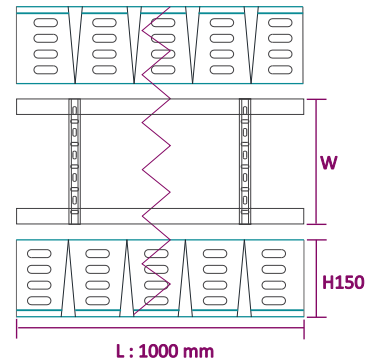
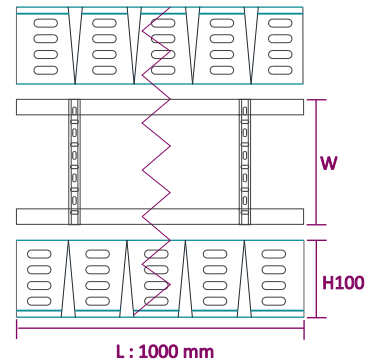
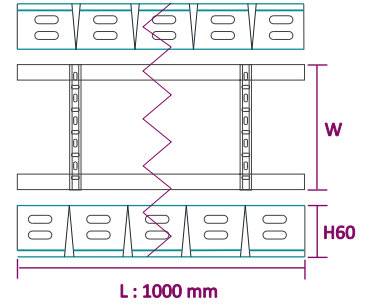
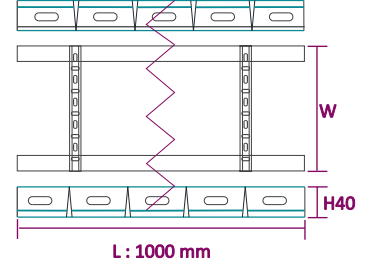

* Farklı kalınlık ve ölçülerde üretim yapılabılır.
* Malzeme ağırlıkları yaklaşık değerlerdir, ± %10 değişiklik gösterebilir.
* Malzeme kalınlık toleransı ± %10 dur.
* Lütfen siparişlerinizde sipariş kodu veya ürün kodu ve kaplama şeklini belirtiniz.

* We can produce cable trays different thickness and dimensions
* Cable trays are shown approximately weight, they could change ± %10 difference.
* Cable trays thickness tolerances are shown ± %10 .
* Please indicate order code and coating type in your orders.

AKM SERIES

İÇ BÜKEY DÖNÜS (SABIT)

CONSTANT INSIDE VERTICAL BENDS

SICAK DALDIRMA (SD)
HOT DIP GALVANIZED (HDG)
TS EN ISO 1461



H40 = Tek delikli
H40 = One hole

H60 = İki delikli
H60 = Two holes

H100 = H150 = Dört delikli
H100 = H150 = Four holes



H40

Sipariş Kodu Order Code	W (mm)	T1/T2 (mm)	Ağırlık (kg/ad) Weight (kg/pcs)	Barkod Kodu Barcode Code
40 AKM 100B S1	100	1.50 mm	1,935	2002600
40 AKM 200B S1	200	1.50 mm	2,164	2002601
40 AKM 300B S1	300	1.50 mm	2,393	2002602
40 AKM 400B S1	400	2.00 mm	3,236	2002603
40 AKM 500B S1	500	2.00 mm	3,465	2002604
40 AKM 600B S1	600	2.00 mm	3,694	2002605

H60

Sipariş Kodu Order Code	W (mm)	T1/T2 (mm)	Ağırlık (kg/ad) Weight (kg/pcs)	Barkod Kodu Barcode Code
60 AKM 100B S1	100	1.50 mm	2,399	2002612
60 AKM 200B S1	200	1.50 mm	2,628	2002613
60 AKM 300B S1	300	1.50 mm	2,857	2002614
60 AKM 400B S1	400	2.00 mm	3,866	2002615
60 AKM 500B S1	500	2.00 mm	4,095	2002616
60 AKM 600B S1	600	2.00 mm	4,324	2002617

H100

Sipariş Kodu Order Code	W (mm)	T1/T2 (mm)	Ağırlık (kg/ad) Weight (kg/pcs)	Barkod Kodu Barcode Code
100 AKM 100B S1	100	1.50 mm	3,355	2002624
100 AKM 200B S1	200	1.50 mm	3,661	2002625
100 AKM 300B S1	300	1.50 mm	3,968	2002626
100 AKM 400B S1	400	2.00 mm	5,368	2002627
100 AKM 500B S1	500	2.00 mm	5,675	2002628
100 AKM 600B S1	600	2.00 mm	5,981	2002629

H150

Sipariş Kodu Order Code	W (mm)	T1/T2 (mm)	Ağırlık (kg/ad) Weight (kg/pcs)	Barkod Kodu Barcode Code
150 AKM 200B S1	200	1.50 mm	4,822	2002630
150 AKM 300B S1	300	1.50 mm	5,128	2002631
150 AKM 400B S1	400	2.00 mm	6,943	2002632
150 AKM 500B S1	500	2.00 mm	7,250	2002633
150 AKM 600B S1	600	2.00 mm	7,556	2002634

H = YÜKSEKLİK = HEIGHT / W = GENİŞLİK = WIDTH / T = KALINLIK = THICKNESS

H AKM100 B S1

Yükseklik Kanal Tipi Genişlik Modül
Height Type Width Module

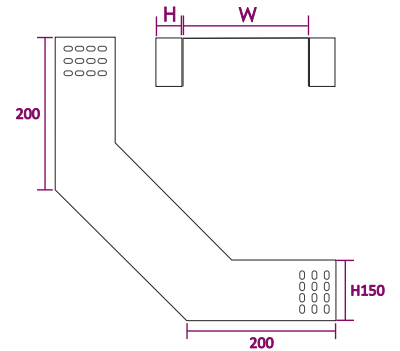
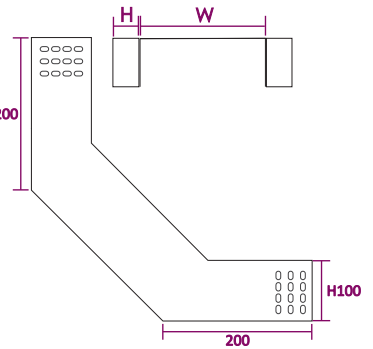
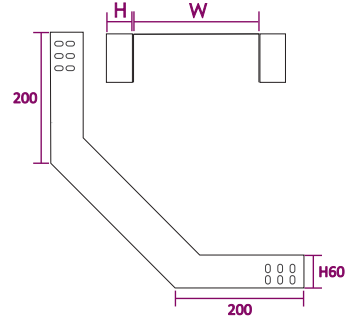
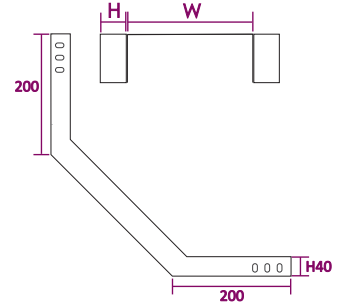

ARTIM METAL ELEKTRİK A.Ş.

* Farklı kalınlık ve ölçülerde üretim yapılabılır.
* Malzeme ağırlıkları yaklaşık değerlerdir, \pm %10 değişiklik gösterebilir.
* Malzeme kalınlık toleransı \pm %10 dur.
* Lütfen siparişlerinizde sipariş kodu veya ürün kodu ve Kaplama şeklini belirtiniz.

* We can produce cable trays different thickness and dimensions
* Cable trays are shown approximately weight, they could change \pm %10 difference.
* Cable trays thickness tolerances are shown \pm %10 .
* Please indicate order code and coating type in your orders.

AKM SERIES

DIS BÜKEY DÖNÜS (SABIT)

CONSTANT OUTSIDE VERTICAL BENDS

SICAK DALDIRMA (SD)

HOT DIP GALVANIZED (HDG)

TS EN ISO 1461



H40 = Tek delikli
H40 = One hole

H60 = İki delikli
H60 = Two holes

H100 = H150 = Dört delikli
H100 = H150 = Four holes



H40

Sipariş Kodu Order Code	W (mm)	T1/T2 (mm)	Ağırlık (kg/ad) Weight (kg/pcs)	Barkod Kodu Barcode Code
40 AKM 100B S2	100	1.50 mm	1,935	2002650
40 AKM 200B S2	200	1.50 mm	2,164	2002651
40 AKM 300B S2	300	1.50 mm	2,393	2002652
40 AKM 400B S2	400	2.00 mm	3,236	2002653
40 AKM 500B S2	500	2.00 mm	3,465	2002654
40 AKM 600B S2	600	2.00 mm	3,694	2002655

H60

Sipariş Kodu Order Code	W (mm)	T1/T2 (mm)	Ağırlık (kg/ad) Weight (kg/pcs)	Barkod Kodu Barcode Code
60 AKM 100B S2	100	1.50 mm	2,399	2002662
60 AKM 200B S2	200	1.50 mm	2,628	2002663
60 AKM 300B S2	300	1.50 mm	2,857	2002664
60 AKM 400B S2	400	2.00 mm	3,866	2002665
60 AKM 500B S2	500	2.00 mm	4,095	2002666
60 AKM 600B S2	600	2.00 mm	4,324	2002667

H100

Sipariş Kodu Order Code	W (mm)	T1/T2 (mm)	Ağırlık (kg/ad) Weight (kg/pcs)	Barkod Kodu Barcode Code
100 AKM 100B S2	100	1.50 mm	3,355	2002674
100 AKM 200B S2	200	1.50 mm	3,661	2002675
100 AKM 300B S2	300	1.50 mm	3,968	2002676
100 AKM 400B S2	400	2.00 mm	5,368	2002677
100 AKM 500B S2	500	2.00 mm	5,675	2002678
100 AKM 600B S2	600	2.00 mm	5,981	2002679

H150

Sipariş Kodu Order Code	W (mm)	T1/T2 (mm)	Ağırlık (kg/ad) Weight (kg/pcs)	Barkod Kodu Barcode Code
150 AKM 200B S2	200	1.50 mm	4,822	2002680
150 AKM 300B S2	300	1.50 mm	5,128	2002681
150 AKM 400B S2	400	2.00 mm	6,943	2002682
150 AKM 500B S2	500	2.00 mm	7,250	2002683
150 AKM 600B S2	600	2.00 mm	7,556	2002684

H = YÜKSEKLİK = HEIGHT / W = GENİŞLİK = WIDTH / T = KALINLIK = THICKNESS

H AKM 100 B S2

Yükseklik Kanal Tipi Genişlik Modül
Height Type Width Module

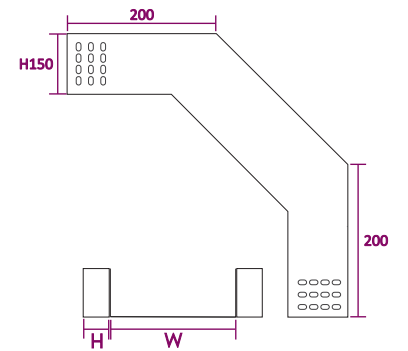
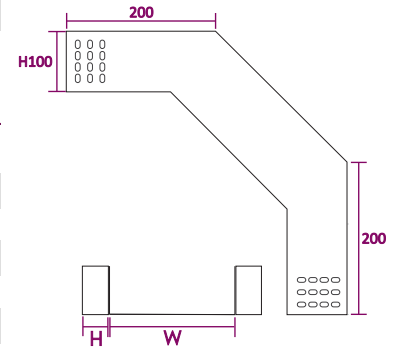
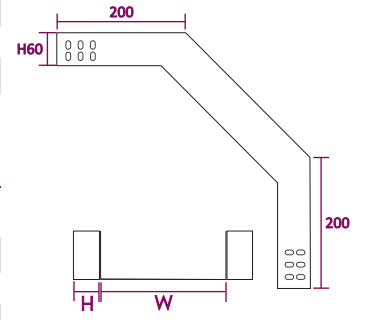
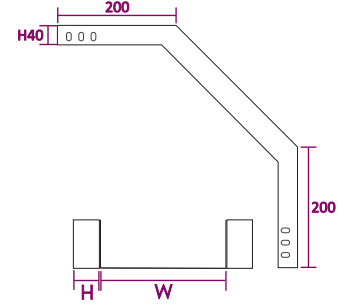

* Farklı kalınlık ve ölçülerde üretim yapıla bilinir.
* Malzeme ağırlıkları yaklaşık değerlerdir, ± %10 değişiklik gösterebilir.
* Malzeme kalınlık toleransı ± %10 dur.
* Lütfen siparişlerinizde sipariş kodu veya ürün kodu ve Kaplama şeklini belirtiniz.

* We can produce cable trays different thickness and dimensions
* Cable trays are shown approximately weight, they could change ± %10 difference.
* Cable trays thickness tolerances are shown ± %10 .
* Please indicate order code and coating type in your orders.

AKM SERIES

DIKEY T BAGLANTI

VERTICAL TEES

SICAK DALDIRMA (SD)
HOT DIP GALVANIZED (HDG)
TS EN ISO 1461



H40 = Tek delikli
H40 = One hole

H60 = İki delikli
H60 = Two holes

H100 = H150 = Dört delikli
H100 = H150 = Four holes



H40

Sipariş Kodu Order Code	W (mm)	T1/T2 (mm)	Ağırlık (kg/ad) Weight (kg/pcs)	Barkod Kodu Barcode Code
40 AKM 100DD	100	1.50 mm	2,910	2002700
40 AKM 200DD	200	1.50 mm	3,868	2002701
40 AKM 300DD	300	1.50 mm	4,822	2002702
40 AKM 400DD	400	2.00 mm	7,719	2002703
40 AKM 500DD	500	2.00 mm	8,997	2002704
40 AKM 600DD	600	2.00 mm	10,276	2002705

H60

Sipariş Kodu Order Code	W (mm)	T1/T2 (mm)	Ağırlık (kg/ad) Weight (kg/pcs)	Barkod Kodu Barcode Code
60 AKM 100DD	100	1.50 mm	3,329	2002712
60 AKM 200DD	200	1.50 mm	4,338	2002713
60 AKM 300DD	300	1.50 mm	5,342	2002714
60 AKM 400DD	400	2.00 mm	8,486	2002715
60 AKM 500DD	500	2.00 mm	9,839	2002716
60 AKM 600DD	600	2.00 mm	11,187	2002717

H100

Sipariş Kodu Order Code	W (mm)	T1/T2 (mm)	Ağırlık (kg/ad) Weight (kg/pcs)	Barkod Kodu Barcode Code
100 AKM 100DD	100	1.50 mm	4,260	2002724
100 AKM 200DD	200	1.50 mm	5,925	2002725
100 AKM 300DD	300	1.50 mm	6,815	2002726
100 AKM 400DD	400	2.00 mm	10,785	2002727
100 AKM 500DD	500	2.00 mm	12,490	2002728
100 AKM 600DD	600	2.00 mm	14,195	2002729

H150

Sipariş Kodu Order Code	W (mm)	T1/T2 (mm)	Ağırlık (kg/ad) Weight (kg/pcs)	Barkod Kodu Barcode Code
150 AKM 200DD	200	1.50 mm	7,260	2002730
150 AKM 300DD	300	1.50 mm	8,850	2002731
150 AKM 400DD	400	2.00 mm	13,280	2002732
150 AKM 500DD	500	2.00 mm	15,240	2002733
150 AKM 600DD	600	2.00 mm	17,200	2002734

H = YÜKSEKLİK = HEIGHT / W = GENİŞLİK = WIDTH / T = KALINLIK = THICKNESS

H AKM100 DD

Yükseklik Kanal Tipi Genişlik Modül
Height Type Width Module

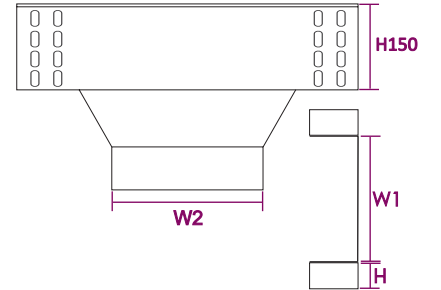
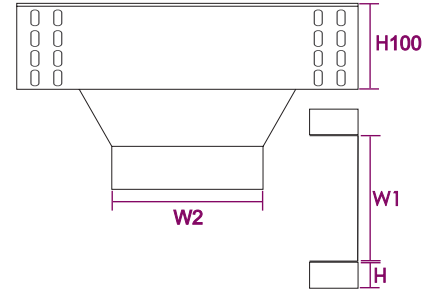
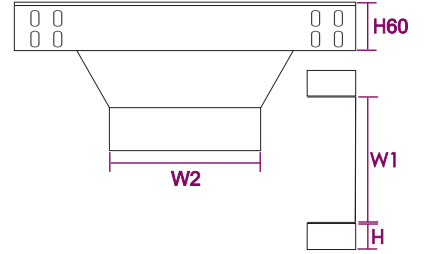
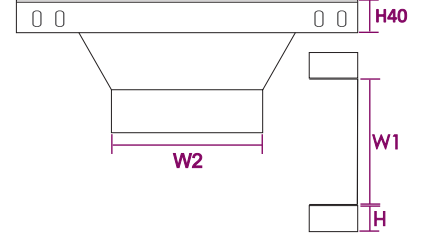

ARTIM METAL ELEKTRİK A.Ş.

* Farklı kalınlık ve ölçülerde üretim yapılabilmektedir.
* Malzeme ağırlıkları yaklaşık değerlerdir, \pm %10 değişiklik gösterebilir.
* Malzeme kalınlık toleransı \pm %10 dur.
* Lütfen siparişlerinizde sipariş kodu veya ürün kodu ve kaplama şeklini belirtiniz.

* We can produce cable trays different thickness and dimensions
* Cable trays are shown approximately weight, they could change \pm %10 difference.
* Cable trays thickness tolerances are shown \pm %10 .
* Please indicate order code and coating type in your orders.

AKM SERIES

ORTADAN T BAĞLANTI

FROM MIDDLE VERTICAL TEES

SICAK DALDIRMA (SD)

HOT DIP GALVANIZED (HDG)

TS EN ISO 1461



H40 = Tek delikli
H40 = One hole

H60 = İki delikli
H60 = Two holes

H100 = H150 = Dört delikli
H100 = H150 = Four holes



H40

Sipariş Kodu Order Code	W (mm)	T1/T2 (mm)	Ağırlık (kg/ad) Weight (kg/pcs)	Barkod Kodu Barcode Code
40 AKM 100DO	100	1.50 mm	3,282	2002750
40 AKM 200DO	200	1.50 mm	3,515	2002751
40 AKM 300DO	300	1.50 mm	3,743	2002752
40 AKM 400DO	400	2.00 mm	5,319	2002753
40 AKM 500DO	500	2.00 mm	5,635	2002754
40 AKM 600DO	600	2.00 mm	5,947	2002755

H60

Sipariş Kodu Order Code	W (mm)	T1/T2 (mm)	Ağırlık (kg/ad) Weight (kg/pcs)	Barkod Kodu Barcode Code
60 AKM 100DO	100	1.50 mm	3,906	2002762
60 AKM 200DO	200	1.50 mm	4,138	2002763
60 AKM 300DO	300	1.50 mm	4,371	2002764
60 AKM 400DO	400	2.00 mm	6,151	2002765
60 AKM 500DO	500	2.00 mm	6,468	2002766
60 AKM 600DO	600	2.00 mm	6,779	2002767

H100

Sipariş Kodu Order Code	W (mm)	T1/T2 (mm)	Ağırlık (kg/ad) Weight (kg/pcs)	Barkod Kodu Barcode Code
100 AKM 100DO	100	1.50 mm	5,135	2002774
100 AKM 200DO	200	1.50 mm	5,505	2002775
100 AKM 300DO	300	1.50 mm	5,870	2002776
100 AKM 400DO	400	2.00 mm	8,315	2002777
100 AKM 500DO	500	2.00 mm	8,805	2002778
100 AKM 600DO	600	2.00 mm	9,295	2002779

H150

Sipariş Kodu Order Code	W (mm)	T1/T2 (mm)	Ağırlık (kg/ad) Weight (kg/pcs)	Barkod Kodu Barcode Code
150 AKM 200DO	200	1.50 mm	7,470	2002780
150 AKM 300DO	300	1.50 mm	7,960	2002781
150 AKM 400DO	400	2.00 mm	10,620	2002782
150 AKM 500DO	500	2.00 mm	11,110	2002783
150 AKM 600DO	600	2.00 mm	15,595	2002784

H = YÜKSEKLİK = HEIGHT / W = GENİŞLİK = WIDTH / T = KALINLIK = THICKNESS

H AKM100 DD

Yükseklik Kanal Tipi Genişlik Modül
Height Type Width Module

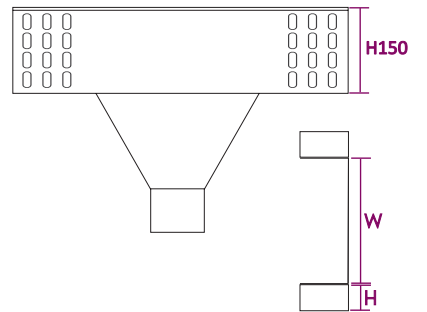
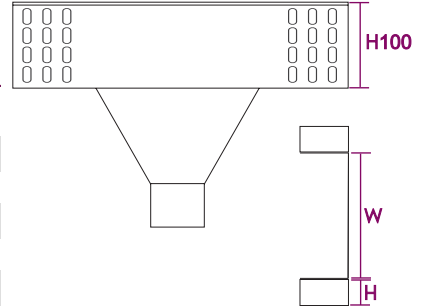
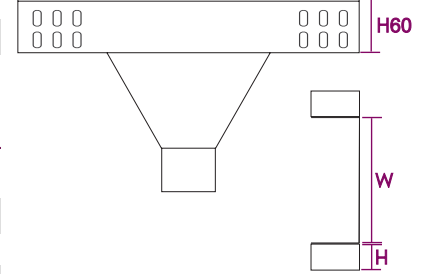
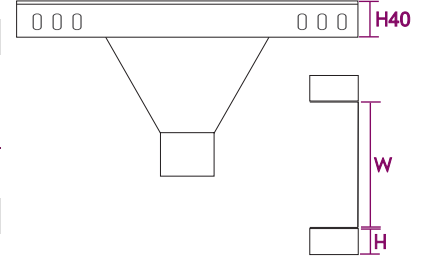

* Farklı kalınlık ve ölçülerde üretim yapıla bilinir.
* Malzeme ağırlıkları yaklaşık değerlerdir, ± %10 değişiklik gösterebilir.
* Malzeme kalınlık toleransı ± %10 dur.
* Lütfen siparişlerinizde sipariş kodu veya ürün kodu ve Kaplama şeklini belirtiniz.

* We can produce cable trays different thickness and dimensions
* Cable trays are shown approximately weight, they could change ± %10 difference.
* Cable trays thickness tolerances are shown ± %10 .
* Please indicate order code and coating type in your orders.

AKM SERIES

EK ELEMANI

STRAIGHT CONNECTION COUPLER

PREGALVANIZ (PG)
PREGALVANIZED (PG)
TS EN 10346



H40 = Tek delikli
H40 = One hole

H60 = İki delikli
H60 = Two holes

H100 = H150 = Dört delikli
H100 = H150 = Four holes

H40

Sipariş Kodu Order Code	T (mm)	Ağırlık (kg/ad) Weight (kg/pcs)	Paket İçi(ad) In Package(Pcs)	Barkod Kodu Barcode Code
40 AST 1	1.20 mm	0,088	300	2001001
40 AST 2	1.50 mm	0,108	250	2001002
40 AST 3	2.00 mm	0,142	200	2001003

H60

Sipariş Kodu Order Code	T (mm)	Ağırlık (kg/ad) Weight (kg/pcs)	Paket İçi(ad) In Package(Pcs)	Barkod Kodu Barcode Code
60 AST 1	1.20 mm	0,125	200	2001015
60 AST 2	1.50 mm	0,157	-	2001016
60 AST 3	2.00 mm	0,205	-	2001017

H = YÜKSEKLİK = HEIGHT / T = KALINLIK = THICKNESS / L = BOY = LENGTH = 175 mm

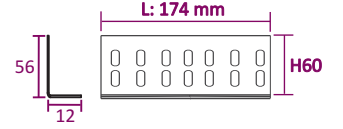
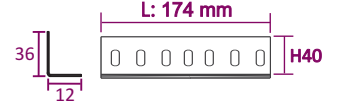

1 Adet H40 - H50 Ek montajı için;
M8x15 Civata 4 Adet M8 Somun 4 Adet kullanılmalıdır.
1 Adet H60 - H75 - H100 Ek montajı için;
M8x15 Civata 8 Adet M8 Somun 8 Adet kullanılmalıdır.

For the installation of 1 H40 - H50 Splice;
M8x15 Bolts 4 Pieces M8 Nuts 4 Pieces must be used.
1 piece H60 - H75 - H100 for additional assembly;
M8x15 Bolts 8 Pieces M8 Nuts 8 Pieces should be used.

H40

Sipariş Kodu Order Code	T (mm)	Ağırlık (kg/ad) Weight (kg/pcs)	Paket İçi(ad) In Package(Pcs)	Barkod Kodu Barcode Code
40 AST 2A	1.50 mm	0,135	-	2001007

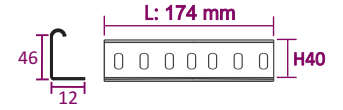

H60

Sipariş Kodu Order Code	T (mm)	Ağırlık (kg/ad) Weight (kg/pcs)	Paket İçi(ad) In Package(Pcs)	Barkod Kodu Barcode Code
60 AST 2A	1.50 mm	0,180	-	2001018

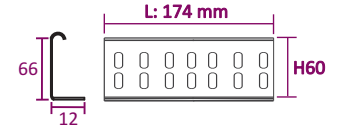

H = YÜKSEKLİK = HEIGHT / T = KALINLIK = THICKNESS / L = BOY = LENGTH = 175 mm

SICAK DALDIRMA (SD)
HOT DIP GALVANIZED (SD)
TS EN ISO 1461



AMR

Sipariş Kodu Order Code	T (mm)	Ağırlık (kg/ad) Weight (kg/pcs)	Paket İçi(ad) In Package(Pcs)	Barkod Kodu Barcode Code
AMR	3.00 mm	0,050	-	2002840

T = KALINLIK = THICKNESS / L = BOY = LENGTH = 74 mm

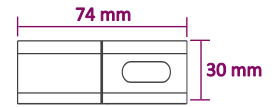

ARTIM METAL ELEKTRİK A.Ş.

* Farklı kalınlık ve ölçülerde üretim yapılabılır.
* Malzeme ağırlıkları yaklaşık değerlerdir, ± %10 değişiklik gösterebilir.
* Malzeme kalınlık toleransı ± %10 dur.
* Lütfen siparişlerinizde sipariş kodu veya ürün kodu ve Kaplama şeklini belirtiniz.

* We can produce cable trays different thickness and dimensions
* Cable trays are shown approximately weight, they could change ± %10 difference.
* Cable trays thickness tolerances are shown ± %10 .
* Please indicate order code and coating type in your orders.

AKM SERIES

EK ELEMANI

STRAIGHT CONNECTION COUPLER

SICAK DALDIRMA (SD)

HOT DIP GALVANIZED (HDG)

TS EN ISO 1461



H40 = Tek delikli
H40 = One hole

H60 = İki delikli
H60 = Two holes

H100 = H150 = Dört delikli
H100 = H150 = Four holes

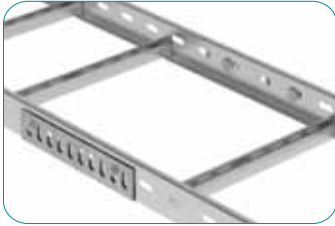

H40				
Sipariş Kodu Order Code	T (mm)	Ağırlık (kg/ad) Weight (kg/pcs)	Paket İçi(ad) In Package(Pcs)	Barkod Kodu Barcode Code
40 AST 1	1.20 mm	0,096	300	2001001
40 AST 2	1.50 mm	0,120	250	2001002
40 AST 3	2.00 mm	0,160	200	2001003

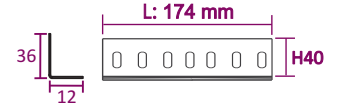

H60				
Sipariş Kodu Order Code	T (mm)	Ağırlık (kg/ad) Weight (kg/pcs)	Paket İçi(ad) In Package(Pcs)	Barkod Kodu Barcode Code
60 AST 1	1.20 mm	0,135	200	2001015
60 AST 2	1.50 mm	0,169	-	2001016
60 AST 3	2.00 mm	0,225	-	2001017

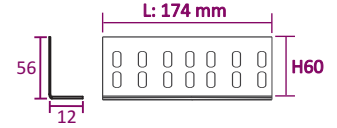

H100				
Sipariş Kodu Order Code	T (mm)	Ağırlık (kg/ad) Weight (kg/pcs)	Paket İçi(ad) In Package(Pcs)	Barkod Kodu Barcode Code
100 AST 1	1.20 mm	0,212	-	2001019
100 AST 2	1.50 mm	0,265	-	2001020
100 AST 3	2.00 mm	0,350	-	2001021

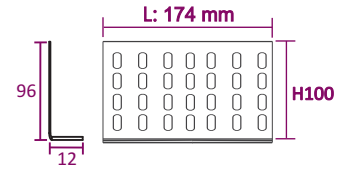

H150				
Sipariş Kodu Order Code	T (mm)	Ağırlık (kg/ad) Weight (kg/pcs)	Paket İçi(ad) In Package(Pcs)	Barkod Kodu Barcode Code
150 AST 2	1.50 mm	0,371	-	2001023
150 AST 3	2.00 mm	0,493	-	2001024

H = YÜKSEKLİK = HEIGHT / T = KALINLIK = THICKNESS / L = BOY = LENGTH = 175 mm

1 Adet H40 - H50 Ek montajı için;
M8x15 Civata 4 Adet M8 Somun 4 Adet kullanılmalıdır.
1 Adet H60 - H75 - H100 Ek montajı için;
M8x15 Civata 8 Adet M8 Somun 8 Adet kullanılmalıdır.

For the installation of 1 H40 - H50 Splice;
M8x15 Bolts 4 Pieces M8 Nuts 4 Pieces must be used.
1 piece H60 - H75 - H100 for additional assembly;
M8x15 Bolts 8 Pieces M8 Nuts 8 Pieces should be used.

H40				
Sipariş Kodu Order Code	T (mm)	Ağırlık (kg/ad) Weight (kg/pcs)	Paket İçi(ad) In Package(Pcs)	Barkod Kodu Barcode Code
40 AST 2A	1.50 mm	0,150	-	2001007

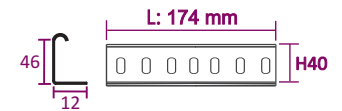

H60				
Sipariş Kodu Order Code	T (mm)	Ağırlık (kg/ad) Weight (kg/pcs)	Paket İçi(ad) In Package(Pcs)	Barkod Kodu Barcode Code
60 AST 2A	1.50 mm	0,195	-	2001018

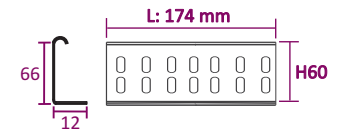

H100				
Sipariş Kodu Order Code	T (mm)	Ağırlık (kg/ad) Weight (kg/pcs)	Paket İçi(ad) In Package(Pcs)	Barkod Kodu Barcode Code
100 AST 2A	1.50 mm	0,390	-	2001022

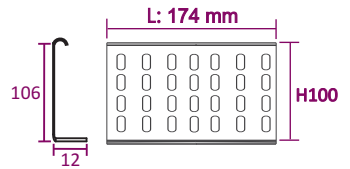

H150				
Sipariş Kodu Order Code	T (mm)	Ağırlık (kg/ad) Weight (kg/pcs)	Paket İçi(ad) In Package(Pcs)	Barkod Kodu Barcode Code
150 AST 2A	1.50 mm	0,449	-	2001025

H = YÜKSEKLİK = HEIGHT / T = KALINLIK = THICKNESS / L = BOY = LENGTH = 175 mm

H40 = Tek delikli
H40 = One hole

H60 = İki delikli
H60 = Two holes

H100 = H150 = Dört delikli
H100 = H150 = Four holes

* Farklı kalınlık ve ölçülerde üretim yapılabılır.
* Malzeme ağırlıkları yaklaşık değerlerdir, ± %10 değişiklik gösterebilir.
* Malzeme kalınlık toleransı ± %10 dur.
* Lütfen siparişlerinizde sipariş kodu veya ürün kodu ve Kaplama şeklini belirtiniz.

* We can produce cable trays different thickness and dimensions
* Cable trays are shown approximately weight, they could change ± %10 difference.
* Cable trays thickness tolerances are shown ± %10 .
* Please indicate order code and coating type in your orders.

AKM SERIES

MERDİVEN SEPERATÖRÜ

SEPARATOR

PREGALVANİZ (PG)
PREGALVANIZED (PG)
TS EN 10346



H40 = H60 = H100 = H150 Tek delikli
H40 = H60 = H100 = H150 One hole

H40

Sipariş Kodu Order Code	L (mm)	T (mm)	Ağırlık (kg/m) Weight (kg/m)	Barkod Kodu Barcode Code
40 AKM SP-12	3.000	1.20 mm	0,398	2002850
40 AKM SP-15	3.000	1.50 mm	0,497	2002851

H60

Sipariş Kodu Order Code	L (mm)	T (mm)	Ağırlık (kg/m) Weight (kg/m)	Barkod Kodu Barcode Code
60 AKM SP-15	3.000	1.50 mm	0,720	2002854

H100

Sipariş Kodu Order Code	L (mm)	T (mm)	Ağırlık (kg/m) Weight (kg/m)	Barkod Kodu Barcode Code
100 AKM SP-15	3.000	1.50 mm	1,185	2002858

H150

Sipariş Kodu Order Code	L (mm)	T (mm)	Ağırlık (kg/m) Weight (kg/m)	Barkod Kodu Barcode Code
150 AKM SP-15	3.000	1.50 mm	1,679	2002861

H = YÜKSEKLİK = HEIGHT / L = BOY = LENGTH / T = KALINLIK = THICKNESS

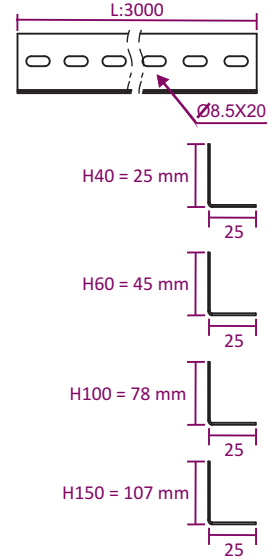
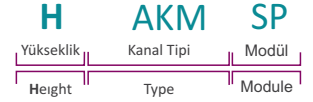

H40 = H60 = H100 = H150 Tek delikli
H40 = H60 = H100 = H150 One hole

H40

Sipariş Kodu Order Code	L (mm)	T (mm)	Ağırlık (kg/m) Weight (kg/m)	Barkod Kodu Barcode Code
40 AKM SP-15A	3.000	1.50 mm	0,607	2002862

H60

Sipariş Kodu Order Code	L (mm)	T (mm)	Ağırlık (kg/m) Weight (kg/m)	Barkod Kodu Barcode Code
60 AKM SP-15A	3.000	1.50 mm	0,827	2002864

H100

Sipariş Kodu Order Code	L (mm)	T (mm)	Ağırlık (kg/m) Weight (kg/m)	Barkod Kodu Barcode Code
100 AKM SP-15A	3.000	1.50 mm	1,301	2002866

H50

Sipariş Kodu Order Code	L (mm)	T (mm)	Ağırlık (kg/m) Weight (kg/m)	Barkod Kodu Barcode Code
150 AKM SP-15A	3.000	1.50 mm	1,845	2002867

H = YÜKSEKLİK = HEIGHT / L = BOY = LENGTH / T = KALINLIK = THICKNESS

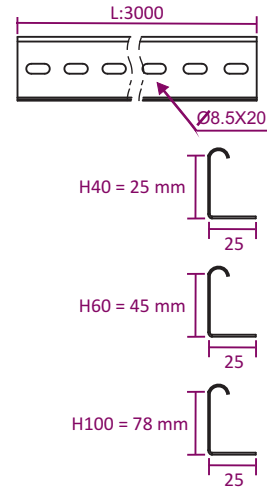

ARTIM METAL ELEKTRİK A.Ş.

- * Farklı kalınlık ve ölçülerde üretim yapılabılır.
- * Malzeme ağırlıkları yaklaşık değerlerdir, \pm %10 değişiklik gösterebilir.
- * Malzeme kalınlık toleransı \pm %10 dur.
- * Lütfen siparişlerinizde sipariş kodu veya ürün kodu ve Kaplama şeklini belirtiniz.

- * We can produce cable trays different thickness and dimensions
- * Cable trays are shown approximately weight, they could change \pm %10 difference.
- * Cable trays thickness tolerances are shown \pm %10 .
- * Please indicate order code and coating type in your orders.

AKM SERIES MERDİVEN SEPERATÖRÜ SEPARATOR

SICAK DALDIRMA (SD)

HOT DIP GALVANIZED (HDG)

TS EN ISO 1461



H40 = H60 = H100 = H150 Tek delikli
H40 = H60 = H100 = H150 One hole

H40

Sipariş Kodu Order Code	L (mm)	T (mm)	Ağırlık (kg/m) Weight (kg/m)	Barkod Kodu Barcode Code
40 AKM SP-12	3.000	1.20 mm	0,430	2002850
40 AKM SP-15	3.000	1.50 mm	0,537	2002851

H60

Sipariş Kodu Order Code	L (mm)	T (mm)	Ağırlık (kg/m) Weight (kg/m)	Barkod Kodu Barcode Code
60 AKM SP-15	3.000	1.50 mm	0,778	2002854

H100

Sipariş Kodu Order Code	L (mm)	T (mm)	Ağırlık (kg/m) Weight (kg/m)	Barkod Kodu Barcode Code
100 AKM SP-15	3.000	1.50 mm	1,280	2002858

H150

Sipariş Kodu Order Code	L (mm)	T (mm)	Ağırlık (kg/m) Weight (kg/m)	Barkod Kodu Barcode Code
150 AKM SP-15	3.000	1.50 mm	1,813	2002861

H = YÜKSEKLİK = HEIGHT / L = BOY = LENGTH / T = KALINLIK = THICKNESS

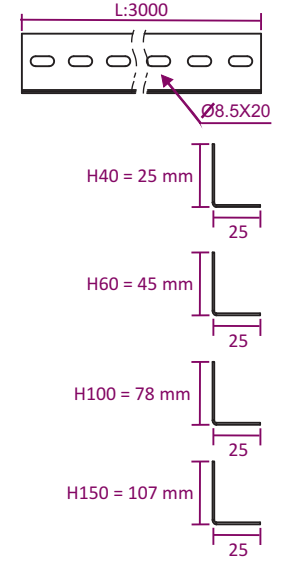
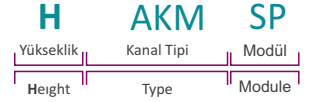

H40 = H60 = H100 = H150 Tek delikli
H40 = H60 = H100 = H150 One hole

H40

Sipariş Kodu Order Code	L (mm)	T (mm)	Ağırlık (kg/m) Weight (kg/m)	Barkod Kodu Barcode Code
40 AKM SP-15A	3.000	1.50 mm	0,656	2002862

H60

Sipariş Kodu Order Code	L (mm)	T (mm)	Ağırlık (kg/m) Weight (kg/m)	Barkod Kodu Barcode Code
60 AKM SP-15A	3.000	1.50 mm	0,893	2002864

H100

Sipariş Kodu Order Code	L (mm)	T (mm)	Ağırlık (kg/m) Weight (kg/m)	Barkod Kodu Barcode Code
100 AKM SP-15A	3.000	1.50 mm	1,405	2002866

H50

Sipariş Kodu Order Code	L (mm)	T (mm)	Ağırlık (kg/m) Weight (kg/m)	Barkod Kodu Barcode Code
150 AKM SP-15A	3.000	1.50 mm	1,993	2002867

H = YÜKSEKLİK = HEIGHT / L = BOY = LENGTH / T = KALINLIK = THICKNESS

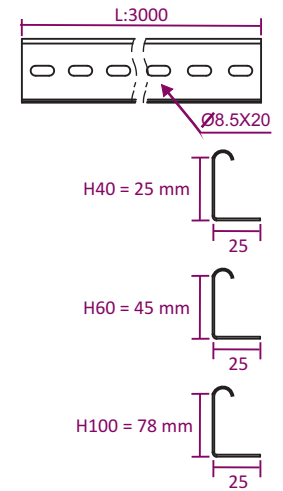

* Farklı kalınlık ve ölçülerde üretim yapılabılır.
* Malzeme ağırlıkları yaklaşık değerlerdir, ± %10 değişiklik gösterebilir.
* Malzeme kalınlık toleransı ± %10 dur.
* Lütfen siparişlerinizde sipariş kodu veya ürün kodu ve Kaplama şeklini belirtiniz.

* We can produce cable trays different thickness and dimensions
* Cable trays are shown approximately weight, they could change ± %10 difference.
* Cable trays thickness tolerances are shown ± %10 .
* Please indicate order code and coating type in your orders.

art

 WWW.ARTIMMETAL.COM

POWER CARRYING SOLUTIONS

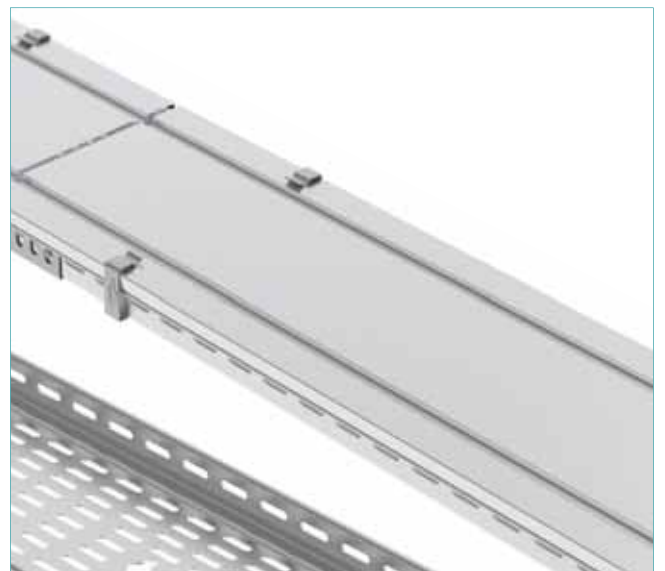
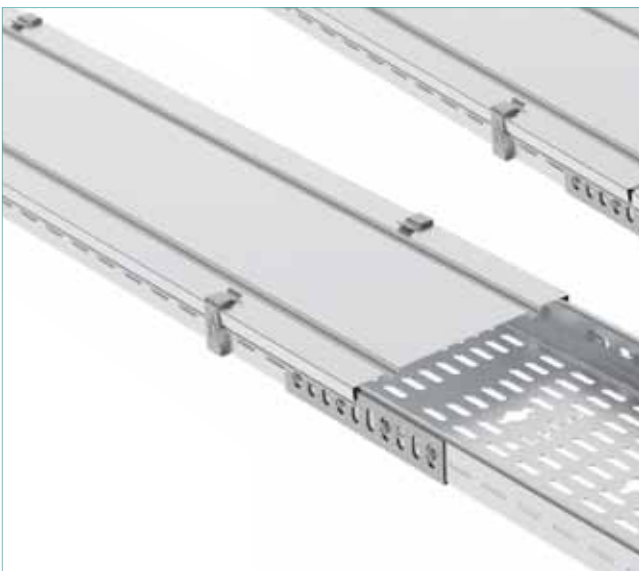
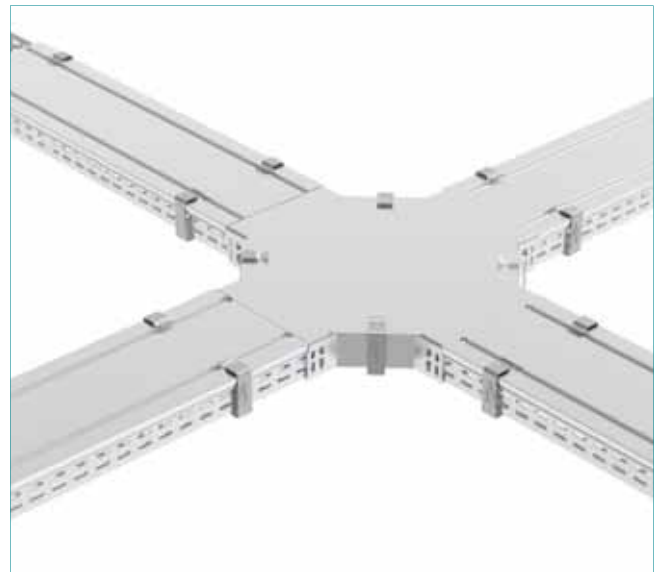
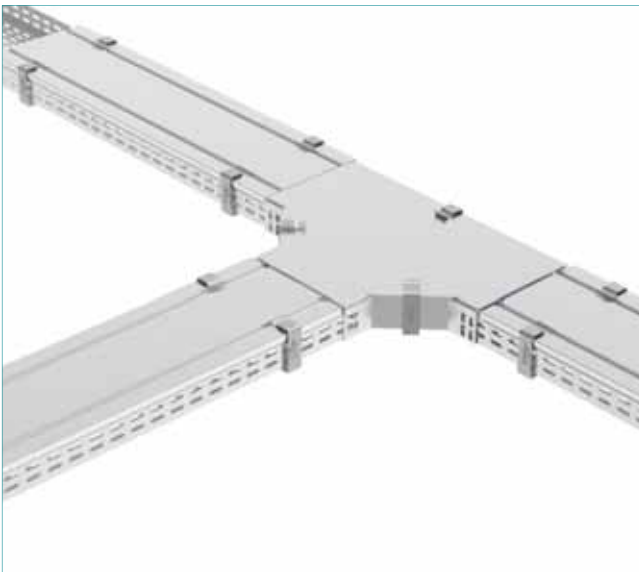

art

POWER CARRYING SOLUTIONS



KABLO KANAL VE MERDİVEN KAPAKLARI

CABLE TRAY AND LADDER COVERS



AKK SERIES

KABLO KANALI VE KABLO MERDİVENİ KAPAKLARI

CABLE TRAY AND CABLE LADDER COVERS

PREGALVANİZ (PG)

PREGALVANIZED (PG)

TS EN 10346



0.80 mm

Sipariş Kodu Order Code	W (mm)	T (mm)	Ağırlık (kg/m) Weight (kg/m)	Barkod Kodu Barcode Code
AKK 050-08	50	0.80 mm	0,440	2002000
AKK 100-08	100	0.80 mm	0,756	2002001
AKK 120-08	120	0.80 mm	0,880	2002002
AKK 160-08	160	0.80 mm	1,132	2002003
AKK 200-09	200	0.90 mm	1,557	2002004

AKK 100 - 10



1.00 mm

Sipariş Kodu Order Code	W (mm)	T (mm)	Ağırlık (kg/m) Weight (kg/m)	Barkod Kodu Barcode Code
AKK 050-10	50	1.00 mm	0,550	2002005
AKK 100-10	100	1.00 mm	0,945	2002006
AKK 120-10	120	1.00 mm	1,100	2002007
AKK 160-10	160	1.00 mm	1,415	2002008
AKK 200-10	200	1.00 mm	1,730	2002009
AKK 300-10	300	1.00 mm	2,512	2002010

1.20 mm

Sipariş Kodu Order Code	W (mm)	T (mm)	Ağırlık (kg/m) Weight (kg/m)	Barkod Kodu Barcode Code
AKK 050-12	50	1.20 mm	0,660	2002011
AKK 100-12	100	1.20 mm	1,130	2002012
AKK 120-12	120	1.20 mm	1,320	2002013
AKK 160-12	160	1.20 mm	1,698	2002014
AKK 200-12	200	1.20 mm	2,075	2002015
AKK 300-12	300	1.20 mm	3,015	2002016
AKK 400-12	400	1.20 mm	3,960	2002017
AKK 500-12	500	1.20 mm	4,000	2002018

1.50 mm

Sipariş Kodu Order Code	W (mm)	T (mm)	Ağırlık (kg/m) Weight (kg/m)	Barkod Kodu Barcode Code
AKK 050-15	50	1.50 mm	0,825	2002019
AKK 100-15	100	1.50 mm	1,415	2002020
AKK 120-15	120	1.50 mm	1,650	2002021
AKK 160-15	160	1.50 mm	2,120	2002022
AKK 200-15	200	1.50 mm	2,595	2002023
AKK 300-15	300	1.50 mm	3,770	2002024
AKK 400-15	400	1.50 mm	4,950	2002025
AKK 500-15	500	1.50 mm	6,125	2002026
AKK 600-15	600	1.50 mm	7,305	2002027

2.00 mm

Sipariş Kodu Order Code	W (mm)	T (mm)	Ağırlık (kg/m) Weight (kg/m)	Barkod Kodu Barcode Code
AKK 050-20	50	2.00 mm	1,100	2002028
AKK 100-20	100	2.00 mm	1,886	2002029
AKK 160-20	160	2.00 mm	2,826	2002031
AKK 200-20	200	2.00 mm	3,460	2002032
AKK 300-20	300	2.00 mm	5,025	2002033
AKK 400-20	400	2.00 mm	6,595	2002034
AKK 500-20	500	2.00 mm	6,165	2002035
AKK 600-20	600	2.00 mm	9,735	2002036

L : 3000

Standart uzunluk L:3000 mm
Toplu miktarlarda Özel ölçüler yapılabilir.
Standard Length L:3000 mm
Custom sizes can be made in bulk quantities.

ARTIM METAL ELEKTRİK A.Ş.

W = GENİŞLİK = WIDTH / T = KALINLIK = THICKNESS

- * Farklı kalınlık ve ölçülerde üretim yapılabılır.
- * Malzeme ağırlıkları yaklaşık değerlerdir, \pm %10 değişiklik gösterebilir.
- * Malzeme kalınlık toleransı \pm %10 dur.
- * Lütfen siparişlerinizde sipariş kodu veya ürün kodu ve Kaplama şeklini belirtiniz.

- * We can produce cable trays different thickness and dimensions
- * Cable trays are shown approximately weight, they could change \pm %10 difference.
- * Cable trays thickness tolerances are shown \pm %10 .
- * Please indicate order code and coating type in your orders.

AKK SERIES

KABLO KANALI VE KABLO MERDİVENİ KAPAKLARI

CABLE TRAY AND CABLE LADDER COVERS

SICAK DALDIRMA (SD)
HOT DIP GALVANIZED (HDG)
TS EN ISO 1461

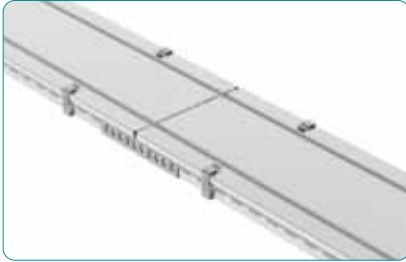

0.80 mm

Sipariş Kodu Order Code	W (mm)	T (mm)	Ağırlık (kg/m) Weight (kg/m)	Barkod Kodu Barcode Code
AKK 050-08	50	0.80 mm	0,485	2002000
AKK 100-08	100	0.80 mm	0,832	2002001
AKK 120-08	120	0.80 mm	0,968	2002002
AKK 160-08	160	0.80 mm	1,244	2002003
AKK 200-09	200	0.90 mm	1,710	2002004

1.00 mm

Sipariş Kodu Order Code	W (mm)	T (mm)	Ağırlık (kg/m) Weight (kg/m)	Barkod Kodu Barcode Code
AKK 050-10	50	1.00 mm	0,604	2002005
AKK 100-10	100	1.00 mm	1,040	2002006
AKK 120-10	120	1.00 mm	1,210	2002007
AKK 160-10	160	1.00 mm	1,555	2002008
AKK 200-10	200	1.00 mm	1,900	2002009
AKK 300-10	300	1.00 mm	2,766	2002010

1.20 mm

Sipariş Kodu Order Code	W (mm)	T (mm)	Ağırlık (kg/m) Weight (kg/m)	Barkod Kodu Barcode Code
AKK 050-12	50	1.20 mm	0,725	2002011
AKK 100-12	100	1.20 mm	1,245	2002012
AKK 120-12	120	1.20 mm	1,452	2002013
AKK 160-12	160	1.20 mm	1,866	2002014
AKK 200-12	200	1.20 mm	2,280	2002015
AKK 300-12	300	1.20 mm	3,320	2002016
AKK 400-12	400	1.20 mm	4,352	2002017
AKK 500-12	500	1.20 mm	5,388	2002018

1.50 mm

Sipariş Kodu Order Code	W (mm)	T (mm)	Ağırlık (kg/m) Weight (kg/m)	Barkod Kodu Barcode Code
AKK 050-15	50	1.50 mm	0,910	2002019
AKK 100-15	100	1.50 mm	1,555	2002020
AKK 120-15	120	1.50 mm	1,815	2002021
AKK 160-15	160	1.50 mm	2,335	2002022
AKK 200-15	200	1.50 mm	2,850	2002023
AKK 300-15	300	1.50 mm	4,145	2002024
AKK 400-15	400	1.50 mm	5,440	2002025
AKK 500-15	500	1.50 mm	6,735	2002026
AKK 600-15	600	1.50 mm	8,035	2002027

2.00 mm

Sipariş Kodu Order Code	W (mm)	T (mm)	Ağırlık (kg/m) Weight (kg/m)	Barkod Kodu Barcode Code
AKK 050-20	50	2.00 mm	1,213	2002028
AKK 100-20	100	2.00 mm	2,073	2002029
AKK 160-20	160	2.00 mm	3,113	2002031
AKK 200-20	200	2.00 mm	3,800	2002032
AKK 300-20	300	2.00 mm	5,530	2002033
AKK 400-20	400	2.00 mm	7,255	2002034
AKK 500-20	500	2.00 mm	8,980	2002035
AKK 600-20	600	2.00 mm	10,710	2002036

W = GENİŞLİK = WIDTH / T = KALINLIK = THICKNESS

AKK 100 - 10



L : 3000

Standart uzunluk L:3000 mm
Toplu miktarlarda Özel ölçüler yapılabilir.
Standard Length L:3000 mm
Custom sizes can be made in bulk quantities.

* Farklı kalınlık ve ölçülerde üretim yapılabılır.
* Malzeme ağırlıkları yaklaşık değerlerdir, \pm %10 değişiklik gösterebilir.
* Malzeme kalınlık toleransı \pm %10 dur.
* Lütfen siparişlerinizde sipariş kodu veya ürün kodu ve Kaplama şeklini belirtiniz.

* We can produce cable trays different thickness and dimensions
* Cable trays are shown approximately weight, they could change \pm %10 difference.
* Cable trays thickness tolerances are shown \pm %10 .
* Please indicate order code and coating type in your orders.

AKK SERIES

KABLO KANALI 90° YATAY DÖNÜS KAPAGI

CABLE TRAY 90° BEND COVERS

PREGALVANİZ (PG)
PREGALVANIZED (PG)
TS EN 10346



90°

Sipariş Kodu Order Code	W (mm)	T (mm)	Ağırlık (kg/ad) Weight (kg/pcs)	Barkod Kodu Barcode Code
AKK 050Y	50	1.20 mm	0,120	2001601
AKK 100Y	100	1.20 mm	0,245	2001602
AKK 120Y	120	1.20 mm	0,310	2001603
AKK 160Y	160	1.20 mm	0,455	2001604
AKK 200Y	200	1.20 mm	0,635	2001605
AKK 300Y	300	1.20 mm	1,200	2001606
AKK 400Y	400	1.50 mm	2,440	2001607
AKK 500Y	500	1.50 mm	3,605	2001608
AKK 600Y	600	1.50 mm	4,995	2001609

AKK 100- Y

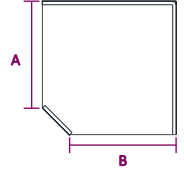

R300

Sipariş Kodu Order Code	W (mm)	T (mm)	Ağırlık (kg/ad) Weight (kg/pcs)	Barkod Kodu Barcode Code
AKK 050Y	50	1.20 mm	0,132	2001611
AKK 100Y	100	1.20 mm	0,270	2001612
AKK 120Y	120	1.20 mm	0,341	2001613
AKK 160Y	160	1.20 mm	0,501	2001614
AKK 200Y	200	1.20 mm	0,699	2001615
AKK 300Y	300	1.20 mm	1,320	2001616
AKK 400Y	400	1.50 mm	2,684	2001617
AKK 500Y	500	1.50 mm	3,966	2001618
AKK 600Y	600	1.50 mm	5,495	2001619

Dönüşlerde "A-B" ölçüleri esit olarak üretilmektedir. İsteğe bağlı olarak farklı ölçülerde üretim yapılır. Bends are produced same dimension for "A-B" as well as we can produce special dimensions regarding your inquiry.

R450

Sipariş Kodu Order Code	W (mm)	T (mm)	Ağırlık (kg/ad) Weight (kg/pcs)	Barkod Kodu Barcode Code
AKK 050Y	50	1.20 mm	0,145	2001621
AKK 100Y	100	1.20 mm	0,296	2001622
AKK 120Y	120	1.20 mm	0,375	2001623
AKK 160Y	160	1.20 mm	0,551	2001624
AKK 200Y	200	1.20 mm	0,768	2001625
AKK 300Y	300	1.20 mm	1,452	2001626
AKK 400Y	400	1.50 mm	2,952	2001627
AKK 500Y	500	1.50 mm	4,362	2001628
AKK 600Y	600	1.50 mm	6,044	2001629

R600

Sipariş Kodu Order Code	W (mm)	T (mm)	Ağırlık (kg/ad) Weight (kg/pcs)	Barkod Kodu Barcode Code
AKK 050Y	50	1.20 mm	0,160	2001631
AKK 100Y	100	1.20 mm	0,326	2001632
AKK 120Y	120	1.20 mm	0,413	2001633
AKK 160Y	160	1.20 mm	0,606	2001634
AKK 200Y	200	1.20 mm	0,845	2001635
AKK 300Y	300	1.20 mm	1,597	2001636
AKK 400Y	400	1.50 mm	3,248	2001637
AKK 500Y	500	1.50 mm	4,798	2001638
AKK 600Y	600	1.50 mm	6,648	2001639

W = GENİŞLİK = WIDTH / T = KALINLIK = THICKNESS

ARTIM METAL ELEKTRİK A.Ş.

* Farklı kalınlık ve ölçülerde üretim yapılabılır.
* Malzeme ağırlıkları yaklaşık değerlerdir, ± %10 değişiklik gösterebilir.
* Malzeme kalınlık toleransı ± %10 dur.
* Lütfen siparişlerinizde sipariş kodu veya ürün kodu ve Kaplama şeklini belirtiniz.

* We can produce cable trays different thickness and dimensions
* Cable trays are shown approximately weight, they could change ± %10 difference.
* Cable trays thickness tolerances are shown ± %10 .
* Please indicate order code and coating type in your orders.

AKK SERIES

KABLO KANALI 90° YATAY DÖNÜS KAPAGI

CABLE TRAY 90° BEND COVERS

SICAK DALDIRMA (SD)

HOT DIP GALVANIZED (HDG)

TS EN ISO 1461



90°

Sipariş Kodu Order Code	W (mm)	T (mm)	Ağırlık (kg/ad) Weight (kg/pcs)	Barkod Kodu Barcode Code
AKK 050Y	50	1.20 mm	0,160	2001601
AKK 100Y	100	1.20 mm	0,345	2001602
AKK 120Y	120	1.20 mm	0,435	2001603
AKK 160Y	160	1.20 mm	0,650	2001604
AKK 200Y	200	1.20 mm	0,900	2001605
AKK 300Y	300	1.20 mm	1,720	2001606
AKK 400Y	400	1.50 mm	3,730	2001607
AKK 500Y	500	1.50 mm	5,515	2001608
AKK 600Y	600	1.50 mm	7,645	2001609

AKK 100- Y

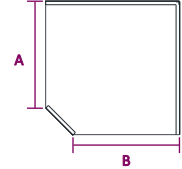

R300

Sipariş Kodu Order Code	W (mm)	T (mm)	Ağırlık (kg/ad) Weight (kg/pcs)	Barkod Kodu Barcode Code
AKK 050Y	50	1.20 mm	0,176	2001611
AKK 100Y	100	1.20 mm	0,380	2001612
AKK 120Y	120	1.20 mm	0,479	2001613
AKK 160Y	160	1.20 mm	0,715	2001614
AKK 200Y	200	1.20 mm	0,990	2001615
AKK 300Y	300	1.20 mm	1,892	2001616
AKK 400Y	400	1.50 mm	4,103	2001617
AKK 500Y	500	1.50 mm	6,067	2001618
AKK 600Y	600	1.50 mm	8,410	2001619

Dönüşlerde "A-B" ölçüleri eşit olarak üretilmektedir. İsteğe bağlı olarak farklı ölçülerde üretim yapılır. Bends are produced same dimension for "A-B" as well as we can produce special dimensions regarding your inquiry.

R450

Sipariş Kodu Order Code	W (mm)	T (mm)	Ağırlık (kg/ad) Weight (kg/pcs)	Barkod Kodu Barcode Code
AKK 050Y	50	1.20 mm	0,194	2001621
AKK 100Y	100	1.20 mm	0,417	2001622
AKK 120Y	120	1.20 mm	0,526	2001623
AKK 160Y	160	1.20 mm	0,787	2001624
AKK 200Y	200	1.20 mm	1,089	2001625
AKK 300Y	300	1.20 mm	2,081	2001626
AKK 400Y	400	1.50 mm	4,513	2001627
AKK 500Y	500	1.50 mm	6,673	2001628
AKK 600Y	600	1.50 mm	9,250	2001629

R600

Sipariş Kodu Order Code	W (mm)	T (mm)	Ağırlık (kg/ad) Weight (kg/pcs)	Barkod Kodu Barcode Code
AKK 050Y	50	1.20 mm	0,213	2001631
AKK 100Y	100	1.20 mm	0,459	2001632
AKK 120Y	120	1.20 mm	0,579	2001633
AKK 160Y	160	1.20 mm	0,865	2001634
AKK 200Y	200	1.20 mm	1,198	2001635
AKK 300Y	300	1.20 mm	2,289	2001636
AKK 400Y	400	1.50 mm	4,965	2001637
AKK 500Y	500	1.50 mm	7,340	2001638
AKK 600Y	600	1.50 mm	10,175	2001639

W = GENİŞLİK = WIDTH / T = KALINLIK = THICKNESS

* Farklı kalınlık ve ölçülerde üretim yapılabılır.
* Malzeme ağırlıkları yaklaşık değerlerdir, ± %10 değişiklik gösterebilir.
* Malzeme kalınlık toleransı ± %10 dur.
* Lütfen siparişlerinizde sipariş kodu veya ürün kodu ve Kaplama şeklini belirtiniz.

* We can produce cable trays different thickness and dimensions
* Cable trays are shown approximately weight, they could change ± %10 difference.
* Cable trays thickness tolerances are shown ± %10 .
* Please indicate order code and coating type in your orders.

AKK SERIES

KABLO KANALI T BAGLANTI KAPAKLARI

CABLE TRAY T BEND COVERS

PREGALVANIZ (PG)
PREGALVANIZED (PG)
TS EN 10346



T

Sipariş Kodu Order Code	W (mm)	T (mm)	Ağırlık (kg/ad) Weight (kg/pcs)	Barkod Kodu Barcode Code
AKK 050T	50	1.20 mm	0,140	2001651
AKK 100T	100	1.20 mm	0,290	2001652
AKK 120T	120	1.20 mm	0,360	2001653
AKK 160T	160	1.20 mm	0,530	2001654
AKK 200T	200	1.20 mm	0,775	2001655
AKK 300T	300	1.20 mm	1,355	2001656
AKK 400T	400	1.50 mm	2,715	2001657
AKK 500T	500	1.50 mm	3,975	2001658
AKK 600T	600	1.50 mm	5,465	2001659

R300

Sipariş Kodu Order Code	W (mm)	T (mm)	Ağırlık (kg/ad) Weight (kg/pcs)	Barkod Kodu Barcode Code
AKK 050T	50	1.20 mm	0,154	2001660
AKK 100T	100	1.20 mm	0,319	2001661
AKK 120T	120	1.20 mm	0,396	2001662
AKK 160T	160	1.20 mm	0,583	2001663
AKK 200T	200	1.20 mm	0,853	2001664
AKK 300T	300	1.20 mm	1,491	2001665
AKK 400T	400	1.50 mm	2,987	2001666
AKK 500T	500	1.50 mm	4,373	2001667
AKK 600T	600	1.50 mm	6,012	2001668

R450

Sipariş Kodu Order Code	W (mm)	T (mm)	Ağırlık (kg/ad) Weight (kg/pcs)	Barkod Kodu Barcode Code
AKK 050T	50	1.20 mm	0,169	2001669
AKK 100T	100	1.20 mm	0,351	2001670
AKK 120T	120	1.20 mm	0,436	2001671
AKK 160T	160	1.20 mm	0,641	2001672
AKK 200T	200	1.20 mm	0,938	2001673
AKK 300T	300	1.20 mm	1,640	2001674
AKK 400T	400	1.50 mm	3,285	2001675
AKK 500T	500	1.50 mm	4,810	2001676
AKK 600T	600	1.50 mm	6,613	2001677

R600

Sipariş Kodu Order Code	W (mm)	T (mm)	Ağırlık (kg/ad) Weight (kg/pcs)	Barkod Kodu Barcode Code
AKK 050T	50	1.20 mm	0,186	2001678
AKK 100T	100	1.20 mm	0,386	2001679
AKK 120T	120	1.20 mm	0,479	2001680
AKK 160T	160	1.20 mm	0,705	2001681
AKK 200T	200	1.20 mm	1,032	2001682
AKK 300T	300	1.20 mm	1,804	2001683
AKK 400T	400	1.50 mm	3,614	2001684
AKK 500T	500	1.50 mm	5,291	2001685
AKK 600T	600	1.50 mm	7,274	2001686

W = GENİŞLİK = WIDTH / T = KALINLIK = THICKNESS

AKK 100- T

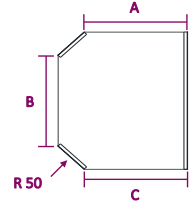

Dönüşlerde "A-B-C" ölçüleri esit olarak üretilmektedir. İsteğe bağlı olarak farklı ölçülerde üretim yapılır. Bends are produced same dimension for "A-B-C" as well as we can produce special dimensions regarding your inquiry.

ARTIM METAL ELEKTRİK A.Ş.

* Farklı kalınlık ve ölçülerde üretim yapılabılır.
* Malzeme ağırlıkları yaklaşık değerlerdir, ± %10 değişiklik gösterebilir.
* Malzeme kalınlık toleransı ± %10 dur.
* Lütfen siparişlerinizde sipariş kodu veya ürün kodu ve Kaplama şeklini belirtiniz.

* We can produce cable trays different thickness and dimensions
* Cable trays are shown approximately weight, they could change ± %10 difference.
* Cable trays thickness tolerances are shown ± %10 .
* Please indicate order code and coating type in your orders.

AKK SERIES

KABLO KANALI T BAĞLANTI KAPAKLARI

CABLE TRAY T BEND COVERS

SICAK DALDIRMA (SD)

HOT DIP GALVANIZED (HDG)

TS EN ISO 1461

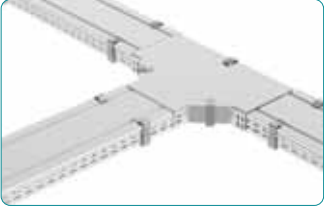

Sipariş Kodu Order Code	W (mm)	T (mm)	Ağırlık (kg/ad) Weight (kg/pcs)	Barkod Kodu Barcode Code
AKK 050T	50	1.20 mm	0,215	2001651
AKK 100T	100	1.20 mm	0,425	2001652
AKK 120T	120	1.20 mm	0,525	2001653
AKK 160T	160	1.20 mm	0,755	2001654
AKK 200T	200	1.20 mm	1,030	2001655
AKK 300T	300	1.20 mm	1,900	2001656
AKK 400T	400	1.50 mm	4,040	2001657
AKK 500T	500	1.50 mm	5,895	2001658
AKK 600T	600	1.50 mm	8,090	2001659

R300

Sipariş Kodu Order Code	W (mm)	T (mm)	Ağırlık (kg/ad) Weight (kg/pcs)	Barkod Kodu Barcode Code
AKK 050T	50	1.20 mm	0,237	2001660
AKK 100T	100	1.20 mm	0,468	2001661
AKK 120T	120	1.20 mm	0,578	2001662
AKK 160T	160	1.20 mm	0,831	2001663
AKK 200T	200	1.20 mm	1,133	2001664
AKK 300T	300	1.20 mm	2,090	2001665
AKK 400T	400	1.50 mm	4,444	2001666
AKK 500T	500	1.50 mm	6,485	2001667
AKK 600T	600	1.50 mm	8,899	2001668

R450

Sipariş Kodu Order Code	W (mm)	T (mm)	Ağırlık (kg/ad) Weight (kg/pcs)	Barkod Kodu Barcode Code
AKK 050T	50	1.20 mm	0,260	2001669
AKK 100T	100	1.20 mm	0,514	2001670
AKK 120T	120	1.20 mm	0,635	2001671
AKK 160T	160	1.20 mm	0,914	2001672
AKK 200T	200	1.20 mm	1,246	2001673
AKK 300T	300	1.20 mm	2,299	2001674
AKK 400T	400	1.50 mm	4,888	2001675
AKK 500T	500	1.50 mm	7,133	2001676
AKK 600T	600	1.50 mm	9,789	2001677

R600

Sipariş Kodu Order Code	W (mm)	T (mm)	Ağırlık (kg/ad) Weight (kg/pcs)	Barkod Kodu Barcode Code
AKK 050T	50	1.20 mm	0,286	2001678
AKK 100T	100	1.20 mm	0,566	2001679
AKK 120T	120	1.20 mm	0,699	2001680
AKK 160T	160	1.20 mm	1,005	2001681
AKK 200T	200	1.20 mm	1,371	2001682
AKK 300T	300	1.20 mm	2,529	2001683
AKK 400T	400	1.50 mm	5,377	2001684
AKK 500T	500	1.50 mm	7,846	2001685
AKK 600T	600	1.50 mm	10,768	2001686

W = GENİŞLİK = WIDTH / T = KALINLIK = THICKNESS

AKK 100- T

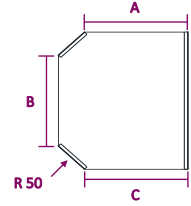

Dönüşlerde "A-B-C" ölçüleri esit olarak üretilmektedir. İsteğe bağlı olarak farklı ölçülerde üretim yapılır.
Bends are produced same dimension for "A-B-C" as well as we can produce special dimensions regarding your inquiry.

* Farklı kalınlık ve ölçülerde üretim yapıla bilinir.
* Malzeme ağırlıkları yaklaşık değerlerdir, ± %10 değişiklik gösterebilir.
* Malzeme kalınlık toleransı ± %10 dur.
* Lütfen siparişlerinizde sipariş kodu veya ürün kodu ve Kaplama şeklini belirtiniz.

* We can produce cable trays different thickness and dimensions
* Cable trays are shown approximately weight, they could change ± %10 difference.
* Cable trays thickness tolerances are shown ± %10 .
* Please indicate order code and coating type in your orders.

AKK SERIES

KABLO KANALI DÖRTLÜ BAĞLANTI KAPAKLARI

CABLE TRAY FOUR WAY CROSSING COVERS

PREGALVANİZ (PG)
PREGALVANIZED (PG)
TS EN 10346



4LÜ

Sipariş Kodu Order Code	W (mm)	T (mm)	Ağırlık (kg/ad) Weight (kg/pcs)	Barkod Kodu Barcode Code
AKK 050D	50	1.20 mm	0,170	2001701
AKK 100D	100	1.20 mm	0,340	2001702
AKK 120D	120	1.20 mm	0,410	2001703
AKK 160D	160	1.20 mm	0,595	2001704
AKK 200D	200	1.20 mm	0,805	2001705
AKK 300D	300	1.20 mm	1,465	2001706
AKK 400D	400	1.50 mm	2,895	2001707
AKK 500D	500	1.50 mm	4,190	2001708
AKK 600D	600	1.50 mm	5,725	2001709

R300

Sipariş Kodu Order Code	W (mm)	T (mm)	Ağırlık (kg/ad) Weight (kg/pcs)	Barkod Kodu Barcode Code
AKK 050D	50	1.20 mm	0,187	2001710
AKK 100D	100	1.20 mm	0,374	2001711
AKK 120D	120	1.20 mm	0,451	2001712
AKK 160D	160	1.20 mm	0,655	2001713
AKK 200D	200	1.20 mm	0,886	2001714
AKK 300D	300	1.20 mm	1,612	2001715
AKK 400D	400	1.50 mm	3,185	2001716
AKK 500D	500	1.50 mm	4,609	2001717
AKK 600D	600	1.50 mm	6,298	2001718

R450

Sipariş Kodu Order Code	W (mm)	T (mm)	Ağırlık (kg/ad) Weight (kg/pcs)	Barkod Kodu Barcode Code
AKK 050D	50	1.20 mm	0,206	2001719
AKK 100D	100	1.20 mm	0,411	2001720
AKK 120D	120	1.20 mm	0,496	2001721
AKK 160D	160	1.20 mm	0,720	2001722
AKK 200D	200	1.20 mm	0,974	2001723
AKK 300D	300	1.20 mm	1,773	2001724
AKK 400D	400	1.50 mm	3,503	2001725
AKK 500D	500	1.50 mm	5,070	2001726
AKK 600D	600	1.50 mm	6,927	2001727

R600

Sipariş Kodu Order Code	W (mm)	T (mm)	Ağırlık (kg/ad) Weight (kg/pcs)	Barkod Kodu Barcode Code
AKK 050D	50	1.20 mm	0,226	2001728
AKK 100D	100	1.20 mm	0,453	2001729
AKK 120D	120	1.20 mm	0,546	2001730
AKK 160D	160	1.20 mm	0,792	2001731
AKK 200D	200	1.20 mm	1,071	2001732
AKK 300D	300	1.20 mm	1,950	2001733
AKK 400D	400	1.50 mm	3,853	2001734
AKK 500D	500	1.50 mm	5,577	2001735
AKK 600D	600	1.50 mm	7,620	2001736

W = GENİŞLİK = WIDTH / T = KALINLIK = THICKNESS

AKK 100- D

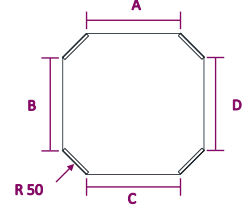

Dönüşlerde "A-B-C-D" ölçüleri esit olarak üretilmektedir. İsteğe bağlı olarak farklı ölçülerde üretim yapılır. Bends are produced same dimension for "A-B-C-D" as well as we can produce special dimensions regarding your inquiry.

ARTIM METAL ELEKTRİK A.Ş.

* Farklı kalınlık ve ölçülerde üretim yapılabılır.
* Malzeme ağırlıkları yaklaşık değerlerdir, \pm %10 değişiklik gösterebilir.
* Malzeme kalınlık toleransı \pm %10 dur.
* Lütfen siparişlerinizde sipariş kodu veya ürün kodu ve Kaplama şeklini belirtiniz.

* We can produce cable trays different thickness and dimensions
* Cable trays are shown approximately weight, they could change \pm %10 difference.
* Cable trays thickness tolerances are shown \pm %10 .
* Please indicate order code and coating type in your orders.

AKK SERIES

KABLO KANALI DÖRTLÜ BAĞLANTI KAPAKLARI

CABLE TRAY FOUR WAY CROSSING COVERS

SICAK DALDIRMA (SD)

HOT DIP GALVANIZED (HDG)

TS EN ISO 1461

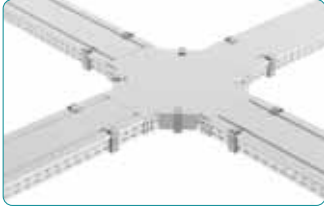

4LÜ

Sipariş Kodu Order Code	W (mm)	T (mm)	Ağırlık (kg/ad) Weight (kg/pcs)	Barkod Kodu Barcode Code
AKK 050D	50	1.20 mm	0,280	2001701
AKK 100D	100	1.20 mm	0,515	2001702
AKK 120D	120	1.20 mm	0,625	2001703
AKK 160D	160	1.20 mm	0,875	2001704
AKK 200D	200	1.20 mm	1,175	2001705
AKK 300D	300	1.20 mm	2,095	2001706
AKK 400D	400	1.50 mm	2,790	2001707
AKK 500D	500	1.50 mm	4,365	2001708
AKK 600D	600	1.50 mm	6,290	2001709

R300

Sipariş Kodu Order Code	W (mm)	T (mm)	Ağırlık (kg/ad) Weight (kg/pcs)	Barkod Kodu Barcode Code
AKK 050D	50	1.20 mm	0,308	2001710
AKK 100D	100	1.20 mm	0,567	2001711
AKK 120D	120	1.20 mm	0,688	2001712
AKK 160D	160	1.20 mm	0,963	2001713
AKK 200D	200	1.20 mm	1,293	2001714
AKK 300D	300	1.20 mm	2,305	2001715
AKK 400D	400	1.50 mm	3,069	2001716
AKK 500D	500	1.50 mm	4,802	2001717
AKK 600D	600	1.50 mm	6,919	2001718

R450

Sipariş Kodu Order Code	W (mm)	T (mm)	Ağırlık (kg/ad) Weight (kg/pcs)	Barkod Kodu Barcode Code
AKK 050D	50	1.20 mm	0,339	2001719
AKK 100D	100	1.20 mm	0,623	2001720
AKK 120D	120	1.20 mm	0,756	2001721
AKK 160D	160	1.20 mm	1,059	2001722
AKK 200D	200	1.20 mm	1,422	2001723
AKK 300D	300	1.20 mm	2,535	2001724
AKK 400D	400	1.50 mm	3,376	2001725
AKK 500D	500	1.50 mm	5,282	2001726
AKK 600D	600	1.50 mm	7,611	2001727

R600

Sipariş Kodu Order Code	W (mm)	T (mm)	Ağırlık (kg/ad) Weight (kg/pcs)	Barkod Kodu Barcode Code
AKK 050D	50	1.20 mm	0,373	2001728
AKK 100D	100	1.20 mm	0,685	2001729
AKK 120D	120	1.20 mm	0,832	2001730
AKK 160D	160	1.20 mm	1,165	2001731
AKK 200D	200	1.20 mm	1,564	2001732
AKK 300D	300	1.20 mm	2,788	2001733
AKK 400D	400	1.50 mm	3,713	2001734
AKK 500D	500	1.50 mm	5,810	2001735
AKK 600D	600	1.50 mm	8,372	2001736

W = GENİŞLİK = WIDTH / T = KALINLIK = THICKNESS

AKK 100- D

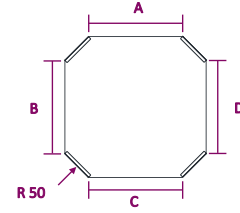

Dönüşlerde "A-B-C-D" ölçüleri esit olarak üretilmektedir. İsteğe bağlı olarak farklı ölçülerde üretim yapılır. Bends are produced same dimension for "A-B-C-D" as well as we can produce special dimensions regarding your inquiry.

* Farklı kalınlık ve ölçülerde üretim yapılabılır.
* Malzeme ağırlıkları yaklaşık değerlerdir, ± %10 değişiklik gösterebilir.
* Malzeme kalınlık toleransı ± %10 dur.
* Lütfen siparişlerinizde sipariş kodu veya ürün kodu ve Kaplama şeklini belirtiniz.

* We can produce cable trays different thickness and dimensions
* Cable trays are shown approximately weight, they could change ± %10 difference.
* Cable trays thickness tolerances are shown ± %10 .
* Please indicate order code and coating type in your orders.

AKK SERIES

45° DÖNÜS KAPAKLARI

45° BEND COVERS

PREGALVANİZ (PG)
PREGALVANIZED (PG)
TS EN 10346



Sipariş Kodu Order Code	W (mm)	T (mm)	Ağırlık (kg/ad) Weight (kg/pcs)	Barkod Kodu Barcode Code
AKK 050Y (45°)	50	1.20 mm	0,135	2001751
AKK 100Y (45°)	100	1.20 mm	0,265	2001752
AKK 120Y (45°)	120	1.20 mm	0,325	2001753
AKK 160Y (45°)	160	1.20 mm	0,460	2001754
AKK 200Y (45°)	200	1.20 mm	0,590	2001755
AKK 300Y (45°)	300	1.20 mm	0,955	2001756
AKK 400Y (45°)	400	1.50 mm	1,795	2001757
AKK 500Y (45°)	500	1.50 mm	2,470	2001758
AKK 600Y (45°)	600	1.50 mm	3,255	2001759

W = GENİŞLİK = WIDTH / T = KALINLIK = THICKNESS

PG

AKK 100 Y (45°)

Kanal Tipi Genişlik Modül
Type Width Module

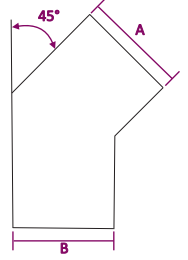

SICAK DALDIRMA (SD)
HOT DIP GALVANIZED (SD)
TS EN ISO 1461



Sipariş Kodu Order Code	W (mm)	T (mm)	Ağırlık (kg/ad) Weight (kg/pcs)	Barkod Kodu Barcode Code
AKK 050Y (45°)	50	1.20 mm	0,215	2001751
AKK 100Y (45°)	100	1.20 mm	0,390	2001752
AKK 120Y (45°)	120	1.20 mm	0,480	2001753
AKK 160Y (45°)	160	1.20 mm	0,555	2001754
AKK 200Y (45°)	200	1.20 mm	0,835	2001755
AKK 300Y (45°)	300	1.20 mm	2,230	2001756
AKK 400Y (45°)	400	1.50 mm	4,200	2001757
AKK 500Y (45°)	500	1.50 mm	5,560	2001758
AKK 600Y (45°)	600	1.50 mm	7,075	2001759

W = GENİŞLİK = WIDTH / T = KALINLIK = THICKNESS

SD

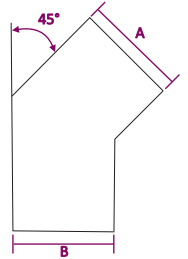

ARTIM METAL ELEKTRİK A.Ş.

- * Farklı kalınlık ve ölçülerde üretim yapılabılır.
- * Malzeme ağırlıkları yaklaşık değerlerdir, \pm %10 değişiklik gösterebilir.
- * Malzeme kalınlık toleransı \pm %10 dur.
- * Lütfen siparişlerinizde sipariş kodu veya ürün kodu ve Kaplama şeklini belirtiniz.

- * We can produce cable trays different thickness and dimensions
- * Cable trays are shown approximately weight, they could change \pm %10 difference.
- * Cable trays thickness tolerances are shown \pm %10 .
- * Please indicate order code and coating type in your orders.

AKK SERIES

İÇ-DİS BÜKEY KAPAKLARI (HAREKETLİ)

ADJUSTABLE INSIDE-OUTSIDE VERTICAL BENDS COVERS

PREGALVANIZ (PG)
PREGALVANIZED (PG)
TS EN 10346



Sipariş Kodu Order Code	W (mm)	T (mm)	Ağırlık (kg/ad) Weight (kg/pcs)	Barkod Kodu Barcode Code
AKK 050B	50	1.20 mm	0,565	2001781
AKK 100B	100	1.20 mm	0,970	2001782
AKK 120B	120	1.20 mm	1,130	2001783
AKK 160B	160	1.20 mm	1,455	2001784
AKK 200B	200	1.20 mm	1,775	2001785
AKK 300B	300	1.20 mm	2,585	2001786
AKK 400B	400	1.50 mm	4,520	2001787
AKK 500B	500	1.50 mm	5,595	2001788
AKK 600B	600	1.50 mm	6,670	2001789

W = GENİŞLİK = WIDTH / T = KALINLIK = THICKNESS

PG

AKK 100- B

Kanal Tipi Genişlik Modül
Type Width Module

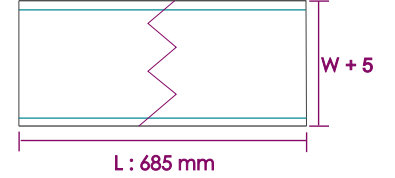

SICAK DALDIRMA (SD)
HOT DIP GALVANIZED (SD)
TS EN ISO 1461



Sipariş Kodu Order Code	W (mm)	T (mm)	Ağırlık (kg/ad) Weight (kg/pcs)	Barkod Kodu Barcode Code
AKK 050B	50	1.20 mm	0,625	2001781
AKK 100B	100	1.20 mm	1,065	2001782
AKK 120B	120	1.20 mm	1,245	2001783
AKK 160B	160	1.20 mm	1,595	2001784
AKK 200B	200	1.20 mm	1,955	2001785
AKK 300B	300	1.20 mm	2,840	2001786
AKK 400B	400	1.50 mm	4,970	2001787
AKK 500B	500	1.50 mm	6,155	2001788
AKK 600B	600	1.50 mm	7,335	2001789

W = GENİŞLİK = WIDTH / T = KALINLIK = THICKNESS

SD

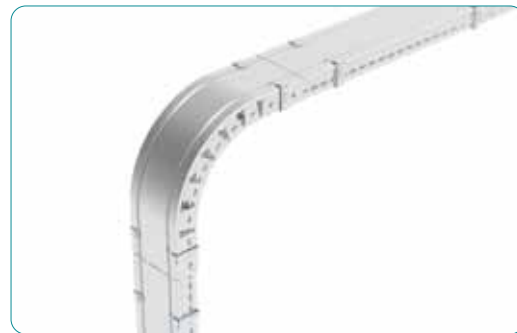
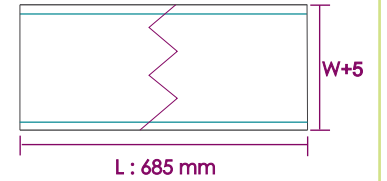

* Farklı kalınlık ve ölçülerde üretim yapıla bilinir.
* Malzeme ağırlıkları yaklaşık değerlerdir, \pm %10 değişiklik gösterebilir.
* Malzeme kalınlık toleransı \pm %10 dur.
* Lütfen siparişlerinizde sipariş kodu veya ürün kodu ve Kaplama şeklini belirtiniz.

* We can produce cable trays different thickness and dimensions
* Cable trays are shown approximately weight, they could change \pm %10 difference.
* Cable trays thickness tolerances are shown \pm %10 .
* Please indicate order code and coating type in your orders.

AKK SERIES

İÇ BÜKEY DÖNÜS KAPAKLARI (SABİT)

CONSTANT INSIDE VERTICAL BENDS COVERS

PREGALVANİZ (PG)
PREGALVANİZED (PG)
TS EN 10346



H40

Sipariş Kodu Order Code	W (mm)	T (mm)	Ağırlık (kg/ad) Weight (kg/pcs)	Barkod Kodu Barcode Code
40 AKK 050B S1	50	1.50 mm	0,440	2001801
40 AKK 100B S1	100	1.50 mm	0,755	2001802
40 AKK 120B S1	120	1.50 mm	0,880	2001803
40 AKK 160B S1	160	1.50 mm	1,130	2001804
40 AKK 200B S1	200	1.50 mm	1,385	2001805
40 AKK 300B S1	300	1.50 mm	2,010	2001806
40 AKK 400B S1	400	2.00 mm	3,520	2001807
40 AKK 500B S1	500	2.00 mm	4,360	2001808
40 AKK 600B S1	600	2.00 mm	5,195	2001809

H50

Sipariş Kodu Order Code	W (mm)	T (mm)	Ağırlık (kg/ad) Weight (kg/pcs)	Barkod Kodu Barcode Code
50 AKK 050B S1	50	1.50 mm	0,462	2001821
50 AKK 100B S1	100	1.50 mm	0,793	2001822
50 AKK 120B S1	120	1.50 mm	0,924	2001823
50 AKK 160B S1	160	1.50 mm	1,187	2001824
50 AKK 200B S1	200	1.50 mm	1,454	2001825
50 AKK 300B S1	300	1.50 mm	2,111	2001826
50 AKK 400B S1	400	2.00 mm	3,696	2001827
50 AKK 500B S1	500	2.00 mm	4,578	2001828
50 AKK 600B S1	600	2.00 mm	5,455	2001829

H60

Sipariş Kodu Order Code	W (mm)	T (mm)	Ağırlık (kg/ad) Weight (kg/pcs)	Barkod Kodu Barcode Code
60 AKK 050B S1	50	1.50 mm	0,485	2001841
60 AKK 100B S1	100	1.50 mm	0,832	2001842
60 AKK 120B S1	120	1.50 mm	0,970	2001843
60 AKK 160B S1	160	1.50 mm	1,246	2001844
60 AKK 200B S1	200	1.50 mm	1,527	2001845
60 AKK 300B S1	300	1.50 mm	2,216	2001846
60 AKK 400B S1	400	2.00 mm	3,881	2001847
60 AKK 500B S1	500	2.00 mm	4,807	2001848
60 AKK 600B S1	600	2.00 mm	5,727	2001849

H100

Sipariş Kodu Order Code	W (mm)	T (mm)	Ağırlık (kg/ad) Weight (kg/pcs)	Barkod Kodu Barcode Code
100 AKK 050B S1	50	1.50 mm	0,534	2001861
100 AKK 100B S1	100	1.50 mm	0,916	2001862
100 AKK 120B S1	120	1.50 mm	1,067	2001863
100 AKK 160B S1	160	1.50 mm	1,370	2001864
100 AKK 200B S1	200	1.50 mm	1,680	2001865
100 AKK 300B S1	300	1.50 mm	2,438	2001866
100 AKK 400B S1	400	2.00 mm	4,269	2001867
100 AKK 500B S1	500	2.00 mm	5,288	2001868
100 AKK 600B S1	600	2.00 mm	6,300	2001869

W = GENİŞLİK = WIDTH / T = KALINLIK = THICKNESS

AKK 100 B S1

Kanal Tipi Genişlik Modül
Type Width Module

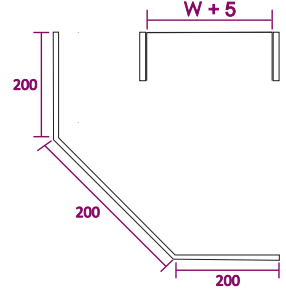

ARTIM METAL ELEKTRİK A.Ş.

* Farklı kalınlık ve ölçülerde üretim yapılabılır.
* Malzeme ağırlıkları yaklaşık değerlerdir, ± %10 değişiklik gösterebilir.
* Malzeme kalınlık toleransı ± %10 dur.
* Lütfen siparişlerinizde sipariş kodu veya ürün kodu ve Kaplama şeklini belirtiniz.

* We can produce cable trays different thickness and dimensions
* Cable trays are shown approximately weight, they could change ± %10 difference.
* Cable trays thickness tolerances are shown ± %10 .
* Please indicate order code and coating type in your orders.

AKK SERIES

İÇ BÜKEY DÖNÜS KAPAKLARI (SABIT)

CONSTANT INSIDE VERTICAL BENDS COVERS

SICAK DALDIRMA (SD)

HOT DIP GALVANIZED (HDG)

TS EN ISO 1461



H40

Sipariş Kodu Order Code	W (mm)	T (mm)	Ağırlık (kg/ad) Weight (kg/pcs)	Barkod Kodu Barcode Code
40 AKK 050B S1	50	1.50 mm	0,485	2001801
40 AKK 100B S1	100	1.50 mm	0,830	2001802
40 AKK 120B S1	120	1.50 mm	0,970	2001803
40 AKK 160B S1	160	1.50 mm	1,245	2001804
40 AKK 200B S1	200	1.50 mm	1,520	2001805
40 AKK 300B S1	300	1.50 mm	2,215	2001806
40 AKK 400B S1	400	2.00 mm	3,875	2001807
40 AKK 500B S1	500	2.00 mm	4,795	2001808
40 AKK 600B S1	600	2.00 mm	5,720	2001809

H50

Sipariş Kodu Order Code	W (mm)	T (mm)	Ağırlık (kg/ad) Weight (kg/pcs)	Barkod Kodu Barcode Code
50 AKK 050B S1	50	1.50 mm	0,509	2001821
50 AKK 100B S1	100	1.50 mm	0,872	2001822
50 AKK 120B S1	120	1.50 mm	1,019	2001823
50 AKK 160B S1	160	1.50 mm	1,307	2001824
50 AKK 200B S1	200	1.50 mm	1,596	2001825
50 AKK 300B S1	300	1.50 mm	2,326	2001826
50 AKK 400B S1	400	2.00 mm	4,069	2001827
50 AKK 500B S1	500	2.00 mm	5,035	2001828
50 AKK 600B S1	600	2.00 mm	6,006	2001829

H60

Sipariş Kodu Order Code	W (mm)	T (mm)	Ağırlık (kg/ad) Weight (kg/pcs)	Barkod Kodu Barcode Code
60 AKK 050B S1	50	1.50 mm	0,535	2001841
60 AKK 100B S1	100	1.50 mm	0,915	2001842
60 AKK 120B S1	120	1.50 mm	1,069	2001843
60 AKK 160B S1	160	1.50 mm	1,373	2001844
60 AKK 200B S1	200	1.50 mm	1,676	2001845
60 AKK 300B S1	300	1.50 mm	2,442	2001846
60 AKK 400B S1	400	2.00 mm	4,272	2001847
60 AKK 500B S1	500	2.00 mm	5,286	2001848
60 AKK 600B S1	600	2.00 mm	6,306	2001849

H100

Sipariş Kodu Order Code	W (mm)	T (mm)	Ağırlık (kg/ad) Weight (kg/pcs)	Barkod Kodu Barcode Code
100 AKK 050B S1	50	1.50 mm	0,588	2001861
100 AKK 100B S1	100	1.50 mm	1,007	2001862
100 AKK 120B S1	120	1.50 mm	1,176	2001863
100 AKK 160B S1	160	1.50 mm	1,510	2001864
100 AKK 200B S1	200	1.50 mm	1,843	2001865
100 AKK 300B S1	300	1.50 mm	2,686	2001866
100 AKK 400B S1	400	2.00 mm	4,699	2001867
100 AKK 500B S1	500	2.00 mm	5,815	2001868
100 AKK 600B S1	600	2.00 mm	6,937	2001869

W = GENİŞLİK = WIDTH / T = KALINLIK = THICKNESS

AKK 100 B S1

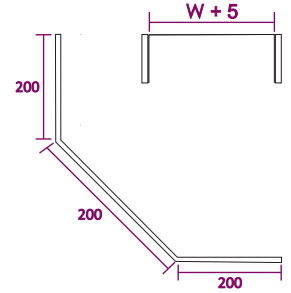

* Farklı kalınlık ve ölçülerde üretim yapılabılır.
* Malzeme ağırlıkları yaklaşık değerlerdir, ± %10 değişiklik gösterebilir.
* Malzeme kalınlık toleransı ± %10 dur.
* Lütfen siparişlerinizde sipariş kodu veya ürün kodu ve kaplama şeklini belirtiniz.

* We can produce cable trays different thickness and dimensions
* Cable trays are shown approximately weight, they could change ± %10 difference.
* Cable trays thickness tolerances are shown ± %10 .
* Please indicate order code and coating type in your orders.

AKK SERIES

DİS BÜKEY DÖNÜS KAPAKLARI (SABIT)

CONSTANT OUTSIDE VERTICAL BENDS COVERS

PREGALVANİZ (PG)
PREGALVANIZED (PG)
TS EN 10346



AKK 100 B S2

Kanal Tipi Genişlik Modül
Type Width Module

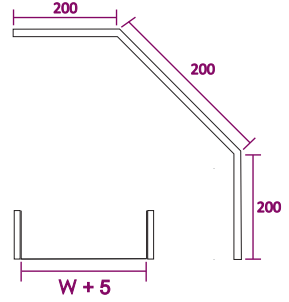

Sipariş Kodu Order Code	W (mm)	T (mm)	Ağırlık (kg/ad) Weight (kg/pcs)	Barkod Kodu Barcode Code
40 AKK 050B S2	50	1.50 mm	0,500	2001881
40 AKK 100B S2	100	1.50 mm	0,855	2001882
40 AKK 120B S2	120	1.50 mm	0,995	2001883
40 AKK 160B S2	160	1.50 mm	1,420	2001884
40 AKK 200B S2	200	1.50 mm	1,560	2001885
40 AKK 300B S2	300	1.50 mm	2,270	2001886
40 AKK 400B S2	400	2.00 mm	3,980	2001887
40 AKK 500B S2	500	2.00 mm	4,925	2001888
40 AKK 600B S2	600	2.00 mm	5,870	2001889

Sipariş Kodu Order Code	W (mm)	T (mm)	Ağırlık (kg/ad) Weight (kg/pcs)	Barkod Kodu Barcode Code
50 AKK 050B S2	50	1.50 mm	0,525	2001901
50 AKK 100B S2	100	1.50 mm	0,898	2001902
50 AKK 120B S2	120	1.50 mm	1,045	2001903
50 AKK 160B S2	160	1.50 mm	1,491	2001904
50 AKK 200B S2	200	1.50 mm	1,638	2001905
50 AKK 300B S2	300	1.50 mm	2,384	2001906
50 AKK 400B S2	400	2.00 mm	4,179	2001907
50 AKK 500B S2	500	2.00 mm	5,171	2001908
50 AKK 600B S2	600	2.00 mm	6,164	2001909

Sipariş Kodu Order Code	W (mm)	T (mm)	Ağırlık (kg/ad) Weight (kg/pcs)	Barkod Kodu Barcode Code
60 AKK 050B S2	50	1.50 mm	0,551	2001921
60 AKK 100B S2	100	1.50 mm	0,943	2001922
60 AKK 120B S2	120	1.50 mm	1,097	2001923
60 AKK 160B S2	160	1.50 mm	1,566	2001924
60 AKK 200B S2	200	1.50 mm	1,720	2001925
60 AKK 300B S2	300	1.50 mm	2,503	2001926
60 AKK 400B S2	400	2.00 mm	4,388	2001927
60 AKK 500B S2	500	2.00 mm	5,430	2001928
60 AKK 600B S2	600	2.00 mm	6,472	2001929

Sipariş Kodu Order Code	W (mm)	T (mm)	Ağırlık (kg/ad) Weight (kg/pcs)	Barkod Kodu Barcode Code
100 AKK 050B S2	50	1.50 mm	0,606	2001941
100 AKK 100B S2	100	1.50 mm	1,037	2001942
100 AKK 120B S2	120	1.50 mm	1,207	2001943
100 AKK 160B S2	160	1.50 mm	1,722	2001944
100 AKK 200B S2	200	1.50 mm	1,892	2001945
100 AKK 300B S2	300	1.50 mm	2,753	2001946
100 AKK 400B S2	400	2.00 mm	4,827	2001947
100 AKK 500B S2	500	2.00 mm	5,973	2001948
100 AKK 600B S2	600	2.00 mm	7,119	2001949

W = GENİŞLİK = WIDTH / T = KALINLIK = THICKNESS

ARTIM METAL ELEKTRİK A.Ş.

* Farklı kalınlık ve ölçülerde üretim yapılabılır.
* Malzeme ağırlıkları yaklaşık değerlerdir, ± %10 değişiklik gösterebilir.
* Malzeme kalınlık toleransı ± %10 dur.
* Lütfen siparişlerinizde sipariş kodu veya ürün kodu ve Kaplama şeklini belirtiniz.

* We can produce cable trays different thickness and dimensions
* Cable trays are shown approximately weight, they could change ± %10 difference.
* Cable trays thickness tolerances are shown ± %10 .
* Please indicate order code and coating type in your orders.

AKK SERIES

DİS BÜKEY DÖNÜS KAPAKLARI (SABIT)

CONSTANT OUTSIDE VERTICAL BENDS COVERS

SICAK DALDIRMA (SD)
HOT DIP GALVANIZED (HDG)
TS EN ISO 1461



H40

Sipariş Kodu Order Code	W (mm)	T (mm)	Ağırlık (kg/ad) Weight (kg/pcs)	Barkod Kodu Barcode Code
40 AKK 050B S2	50	1.50 mm	0,550	2001881
40 AKK 100B S2	100	1.50 mm	0,940	2001882
40 AKK 120B S2	120	1.50 mm	1,095	2001883
40 AKK 160B S2	160	1.50 mm	1,565	2001884
40 AKK 200B S2	200	1.50 mm	1,720	2001885
40 AKK 300B S2	300	1.50 mm	2,500	2001886
40 AKK 400B S2	400	2.00 mm	4,375	2001887
40 AKK 500B S2	500	2.00 mm	5,420	2001888
40 AKK 600B S2	600	2.00 mm	6,460	2001889

H50

Sipariş Kodu Order Code	W (mm)	T (mm)	Ağırlık (kg/ad) Weight (kg/pcs)	Barkod Kodu Barcode Code
50 AKK 050B S2	50	1.50 mm	0,578	2001901
50 AKK 100B S2	100	1.50 mm	0,987	2001902
50 AKK 120B S2	120	1.50 mm	1,150	2001903
50 AKK 160B S2	160	1.50 mm	1,643	2001904
50 AKK 200B S2	200	1.50 mm	1,806	2001905
50 AKK 300B S2	300	1.50 mm	2,625	2001906
50 AKK 400B S2	400	2.00 mm	4,594	2001907
50 AKK 500B S2	500	2.00 mm	5,691	2001908
50 AKK 600B S2	600	2.00 mm	6,783	2001909

H60

Sipariş Kodu Order Code	W (mm)	T (mm)	Ağırlık (kg/ad) Weight (kg/pcs)	Barkod Kodu Barcode Code
60 AKK 050B S2	50	1.50 mm	0,606	2001921
60 AKK 100B S2	100	1.50 mm	1,036	2001922
60 AKK 120B S2	120	1.50 mm	1,207	2001923
60 AKK 160B S2	160	1.50 mm	1,725	2001924
60 AKK 200B S2	200	1.50 mm	1,896	2001925
60 AKK 300B S2	300	1.50 mm	2,756	2001926
60 AKK 400B S2	400	2.00 mm	4,823	2001927
60 AKK 500B S2	500	2.00 mm	5,976	2001928
60 AKK 600B S2	600	2.00 mm	7,122	2001929

H100

Sipariş Kodu Order Code	W (mm)	T (mm)	Ağırlık (kg/ad) Weight (kg/pcs)	Barkod Kodu Barcode Code
100 AKK 050B S2	50	1.50 mm	0,667	2001941
100 AKK 100B S2	100	1.50 mm	1,140	2001942
100 AKK 120B S2	120	1.50 mm	1,328	2001943
100 AKK 160B S2	160	1.50 mm	1,898	2001944
100 AKK 200B S2	200	1.50 mm	2,086	2001945
100 AKK 300B S2	300	1.50 mm	3,032	2001946
100 AKK 400B S2	400	2.00 mm	5,306	2001947
100 AKK 500B S2	500	2.00 mm	6,573	2001948
100 AKK 600B S2	600	2.00 mm	7,834	2001949

W = GENİŞLİK = WIDTH / T = KALINLIK = THICKNESS

AKK 100 B S2

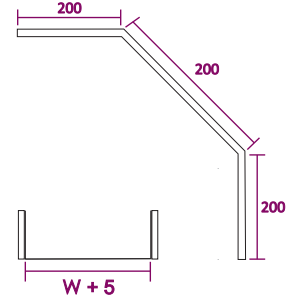

* Farklı kalınlık ve ölçülerde üretim yapıla bilinir.
* Malzeme ağırlıkları yaklaşık değerlerdir, ± %10 değişiklik gösterebilir.
* Malzeme kalınlık toleransı ± %10 dur.
* Lütfen siparişlerinizde sipariş kodu veya ürün kodu ve Kaplama şeklini belirtiniz.

* We can produce cable trays different thickness and dimensions
* Cable trays are shown approximately weight, they could change ± %10 difference.
* Cable trays thickness tolerances are shown ± %10 .
* Please indicate order code and coating type in your orders.

AKK SERIES

DIKEY & ORTADAN T BAGLANTI KAPAKLARI

VERTICAL & MIDDLE T CONNECTION COVERS

PREGALVANİZ (PG)
PREGALVANIZED (PG)
TS EN 10346



PG

Sipariş Kodu Order Code	W (mm)	T (mm)	Ağırlık (kg/ad) Weight (kg/pcs)	Barkod Kodu Barcode Code
AKK 050DDO	50	1.50 mm	0,110	2001961
AKK 100DDO	100	1.50 mm	0,220	2001962
AKK 120DDO	120	1.50 mm	0,264	2001963
AKK 160DDO	160	1.50 mm	0,352	2001964
AKK 200DDO	200	1.50 mm	0,440	2001965
AKK 300DDO	300	1.50 mm	0,659	2001966
AKK 400DDO	400	2.00 mm	0,879	2001967
AKK 500DDO	500	2.00 mm	1,099	2001968
AKK 600DDO	600	2.00 mm	1,319	2001969

AKK 100 Y (45°)

Kanal Tipi Genişlik Modül
Type Width Module

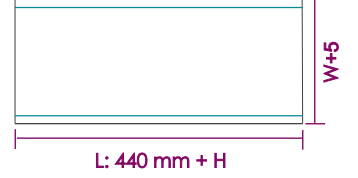

W = GENİŞLİK = WIDTH / T = KALINLIK = THICKNESS

SICAK DALDIRMA (SD)
HOT DIP GALVANIZED (SD)
TS EN ISO 1461



SD

Sipariş Kodu Order Code	W (mm)	T (mm)	Ağırlık (kg/ad) Weight (kg/pcs)	Barkod Kodu Barcode Code
AKK 050DDO	50	1.50 mm	0,121	2001961
AKK 100DDO	100	1.50 mm	0,242	2001962
AKK 120DDO	120	1.50 mm	0,290	2001963
AKK 160DDO	160	1.50 mm	0,387	2001964
AKK 200DDO	200	1.50 mm	0,484	2001965
AKK 300DDO	300	1.50 mm	0,725	2001966
AKK 400DDO	400	2.00 mm	0,967	2001967
AKK 500DDO	500	2.00 mm	1,209	2001968
AKK 600DDO	600	2.00 mm	1,451	2001969

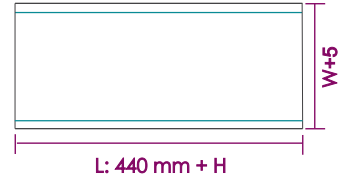

W = GENİŞLİK = WIDTH / T = KALINLIK = THICKNESS

ARTIM METAL ELEKTRİK A.Ş.

* Farklı kalınlık ve ölçülerde üretim yapılabılır.
* Malzeme ağırlıkları yaklaşık değerlerdir, ± %10 değişiklik gösterebilir.
* Malzeme kalınlık toleransı ± %10 dur.
* Lütfen siparişlerinizde sipariş kodu veya ürün kodu ve Kaplama şeklini belirtiniz.

* We can produce cable trays different thickness and dimensions
* Cable trays are shown approximately weight, they could change ± %10 difference.
* Cable trays thickness tolerances are shown ± %10 .
* Please indicate order code and coating type in your orders.

AKK SERIES

MERDIVEN 90° YATAY DÖNÜS KAPAKLARI

LADDER 90° BEND COVERS

SICAK DALDIRMA (SD)

HOT DIP GALVANIZED (HDG)

TS EN ISO 1461



90°

Sipariş Kodu Order Code	W (mm)	T (mm)	Ağırlık (kg/ad) Weight (kg/pcs)	Barkod Kodu Barcode Code
AMK 100Y	100	1.50 mm	1,008	2002101
AMK 200Y	200	1.50 mm	2,235	2002102
AMK 300Y	300	1.50 mm	3,722	2002103
AMK 400Y	400	2.00 mm	7,291	2002104
AMK 500Y	500	2.00 mm	9,966	2002105
AMK 600Y	600	2.00 mm	12,987	2002106
AMK 700Y	700	2.00 mm	16,770	2002107
AMK 800Y	800	2.00 mm	20,096	2002108
AMK 900Y	900	2.00 mm	23,144	2002109
AMK 1000Y	1.000	2.00 mm	26,574	2002108

AMK 100- Y

Kanal Tipi Genişlik Modül
Type Width Module

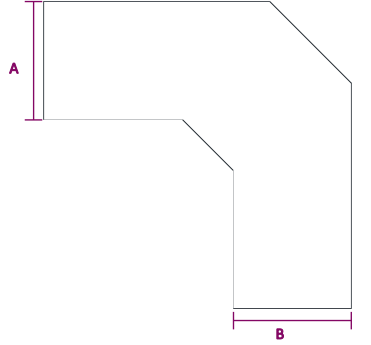

R300

Sipariş Kodu Order Code	W (mm)	T (mm)	Ağırlık (kg/ad) Weight (kg/pcs)	Barkod Kodu Barcode Code
AMK 100Y	100	1.50 mm	1,058	2002101
AMK 200Y	200	1.50 mm	2,347	2002102
AMK 300Y	300	1.50 mm	3,908	2002103
AMK 400Y	400	2.00 mm	7,656	2002104
AMK 500Y	500	2.00 mm	10,464	2002105
AMK 600Y	600	2.00 mm	13,636	2002106
AMK 700Y	700	2.00 mm	17,609	2002107
AMK 800Y	800	2.00 mm	21,101	2002108
AMK 900Y	900	2.00 mm	24,301	2002109
AMK 1000Y	1.000	2.00 mm	27,903	2002108

R450

Sipariş Kodu Order Code	W (mm)	T (mm)	Ağırlık (kg/ad) Weight (kg/pcs)	Barkod Kodu Barcode Code
AMK 100Y	100	1.50 mm	1,143	2002101
AMK 200Y	200	1.50 mm	2,534	2002102
AMK 300Y	300	1.50 mm	4,221	2002103
AMK 400Y	400	2.00 mm	8,268	2002104
AMK 500Y	500	2.00 mm	11,301	2002105
AMK 600Y	600	2.00 mm	14,727	2002106
AMK 700Y	700	2.00 mm	19,017	2002107
AMK 800Y	800	2.00 mm	22,789	2002108
AMK 900Y	900	2.00 mm	26,245	2002109
AMK 1000Y	1.000	2.00 mm	30,135	2002108

R600

Sipariş Kodu Order Code	W (mm)	T (mm)	Ağırlık (kg/ad) Weight (kg/pcs)	Barkod Kodu Barcode Code
AMK 100Y	100	1.50 mm	1,257	2002101
AMK 200Y	200	1.50 mm	2,788	2002102
AMK 300Y	300	1.50 mm	4,643	2002103
AMK 400Y	400	2.00 mm	9,095	2002104
AMK 500Y	500	2.00 mm	12,432	2002105
AMK 600Y	600	2.00 mm	16,200	2002106
AMK 700Y	700	2.00 mm	20,919	2002107
AMK 800Y	800	2.00 mm	25,068	2002108
AMK 900Y	900	2.00 mm	28,870	2002109
AMK 1000Y	1.000	2.00 mm	33,148	2002108

W = GENİŞLİK = WIDTH / T = KALINLIK = THICKNESS

* Farklı kalınlık ve ölçülerde üretim yapılabılır.
* Malzeme ağırlıkları yaklaşık değerlerdir, ± %10 değişiklik gösterebilir.
* Malzeme kalınlık toleransı ± %10 dur.
* Lütfen siparişlerinizde sipariş kodu veya ürün kodu ve Kaplama şeklini belirtiniz.

* We can produce cable trays different thickness and dimensions
* Cable trays are shown approximately weight, they could change ± %10 difference.
* Cable trays thickness tolerances are shown ± %10 .
* Please indicate order code and coating type in your orders.

AKK SERIES

MERDIVEN T BAĞLANTI KAPAKLARI

LADDER T BEND COVERS

SICAK DALDIRMA (SD)
HOT DIP GALVANIZED (HDG)
TS EN ISO 1461



AMK 100- T

Kanal Tipi Genişlik Modül
Type Width Module

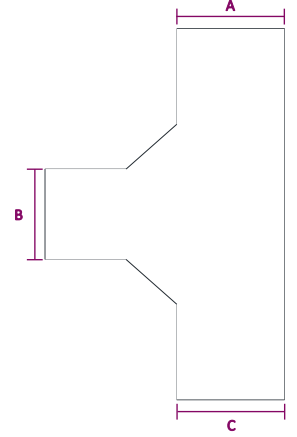

Sipariş Kodu Order Code	W (mm)	T (mm)	Ağırlık (kg/ad) Weight (kg/pcs)	Barkod Kodu Barcode Code
AMK 100T	100	1.50 mm	1,695	2002101
AMK 200T	200	1.50 mm	3,310	2002102
AMK 300T	300	1.50 mm	5,168	2002103
AMK 400T	400	2.00 mm	9,726	2002104
AMK 500T	500	2.00 mm	12,907	2002105
AMK 600T	600	2.00 mm	16,435	2002106
AMK 700T	700	2.00 mm	19,722	2002107
AMK 800T	800	2.00 mm	23,074	2002108
AMK 900T	900	2.00 mm	26,304	2002109
AMK 1000T	1.000	2.00 mm	29,197	2002108

R300

Sipariş Kodu Order Code	W (mm)	T (mm)	Ağırlık (kg/ad) Weight (kg/pcs)	Barkod Kodu Barcode Code
AMK 100T	100	1.50 mm	1,780	2002101
AMK 200T	200	1.50 mm	3,476	2002102
AMK 300T	300	1.50 mm	5,426	2002103
AMK 400T	400	2.00 mm	10,212	2002104
AMK 500T	500	2.00 mm	13,552	2002105
AMK 600T	600	2.00 mm	17,257	2002106
AMK 700T	700	2.00 mm	20,708	2002107
AMK 800T	800	2.00 mm	24,228	2002108
AMK 900T	900	2.00 mm	27,619	2002109
AMK 1000T	1.000	2.00 mm	30,657	2002108

R450

Sipariş Kodu Order Code	W (mm)	T (mm)	Ağırlık (kg/ad) Weight (kg/pcs)	Barkod Kodu Barcode Code
AMK 100T	100	1.50 mm	1,922	2002101
AMK 200T	200	1.50 mm	3,754	2002102
AMK 300T	300	1.50 mm	5,861	2002103
AMK 400T	400	2.00 mm	11,029	2002104
AMK 500T	500	2.00 mm	14,637	2002105
AMK 600T	600	2.00 mm	18,637	2002106
AMK 700T	700	2.00 mm	22,365	2002107
AMK 800T	800	2.00 mm	26,166	2002108
AMK 900T	900	2.00 mm	29,829	2002109
AMK 1000T	1.000	2.00 mm	33,109	2002108

R600

Sipariş Kodu Order Code	W (mm)	T (mm)	Ağırlık (kg/ad) Weight (kg/pcs)	Barkod Kodu Barcode Code
AMK 100T	100	1.50 mm	2,114	2002101
AMK 200T	200	1.50 mm	4,129	2002102
AMK 300T	300	1.50 mm	6,447	2002103
AMK 400T	400	2.00 mm	12,132	2002104
AMK 500T	500	2.00 mm	16,100	2002105
AMK 600T	600	2.00 mm	20,501	2002106
AMK 700T	700	2.00 mm	24,601	2002107
AMK 800T	800	2.00 mm	28,783	2002108
AMK 900T	900	2.00 mm	32,812	2002109
AMK 1000T	1.000	2.00 mm	36,420	2002108

ARTIM METAL ELEKTRİK A.Ş.

W = GENİŞLİK = WIDTH / T = KALINLIK = THICKNESS

* Farklı kalınlık ve ölçülerde üretim yapılabılır.
* Malzeme ağırlıkları yaklaşık değerlerdir, ± %10 değişiklik gösterebilir.
* Malzeme kalınlık toleransı ± %10 dur.
* Lütfen siparişlerinizde sipariş kodu veya ürün kodu ve Kaplama şeklini belirtiniz.

* We can produce cable trays different thickness and dimensions
* Cable trays are shown approximately weight, they could change ± %10 difference.
* Cable trays thickness tolerances are shown ± %10 .
* Please indicate order code and coating type in your orders.

AKK SERIES

MERDIVEN DÖRTLÜ BAĞLANTI KAPAKLARI

LADDER FOUR WAY CROSSING COVERS

SICAK DALDIRMA (SD)

HOT DIP GALVANIZED (HDG)

TS EN ISO 1461



4LÜ

Sipariş Kodu Order Code	W (mm)	T (mm)	Ağırlık (kg/ad) Weight (kg/pcs)	Barkod Kodu Barcode Code
AMK 100D	100	1.50 mm	2,182	2002101
AMK 200D	200	1.50 mm	4,168	2002102
AMK 300D	300	1.50 mm	6,415	2002103
AMK 400D	400	2.00 mm	11,895	2002104
AMK 500D	500	2.00 mm	15,583	2002105
AMK 600D	600	2.00 mm	19,617	2002106
AMK 700D	700	2.00 mm	23,148	2002107
AMK 800D	800	2.00 mm	27,314	2002108
AMK 900D	900	2.00 mm	31,957	2002109
AMK 1000D	1.000	2.00 mm	37,389	2002108

AMK 100- D

Kanal Tipi Genişlik Modül
Type Width Module

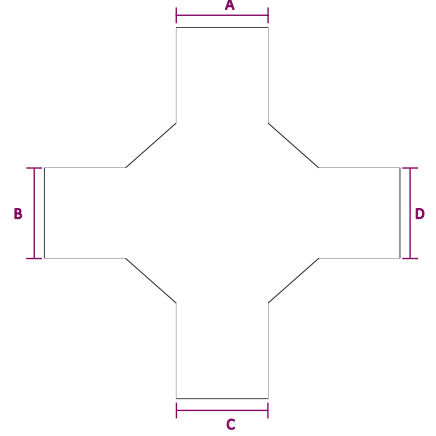

R300

Sipariş Kodu Order Code	W (mm)	T (mm)	Ağırlık (kg/ad) Weight (kg/pcs)	Barkod Kodu Barcode Code
AMK 100D	100	1.50 mm	2,291	2002101
AMK 200D	200	1.50 mm	4,376	2002102
AMK 300D	300	1.50 mm	6,736	2002103
AMK 400D	400	2.00 mm	12,490	2002104
AMK 500D	500	2.00 mm	16,362	2002105
AMK 600D	600	2.00 mm	20,598	2002106
AMK 700D	700	2.00 mm	24,305	2002107
AMK 800D	800	2.00 mm	28,680	2002108
AMK 900D	900	2.00 mm	33,555	2002109
AMK 1000D	1.000	2.00 mm	39,258	2002108

R450

Sipariş Kodu Order Code	W (mm)	T (mm)	Ağırlık (kg/ad) Weight (kg/pcs)	Barkod Kodu Barcode Code
AMK 100D	100	1.50 mm	2,474	2002101
AMK 200D	200	1.50 mm	4,727	2002102
AMK 300D	300	1.50 mm	7,275	2002103
AMK 400D	400	2.00 mm	13,489	2002104
AMK 500D	500	2.00 mm	17,671	2002105
AMK 600D	600	2.00 mm	22,246	2002106
AMK 700D	700	2.00 mm	26,250	2002107
AMK 800D	800	2.00 mm	30,974	2002108
AMK 900D	900	2.00 mm	36,239	2002109
AMK 1000D	1.000	2.00 mm	42,399	2002108

R600

Sipariş Kodu Order Code	W (mm)	T (mm)	Ağırlık (kg/ad) Weight (kg/pcs)	Barkod Kodu Barcode Code
AMK 100D	100	1.50 mm	2,722	2002101
AMK 200D	200	1.50 mm	5,199	2002102
AMK 300D	300	1.50 mm	8,002	2002103
AMK 400D	400	2.00 mm	14,838	2002104
AMK 500D	500	2.00 mm	19,438	2002105
AMK 600D	600	2.00 mm	24,470	2002106
AMK 700D	700	2.00 mm	28,875	2002107
AMK 800D	800	2.00 mm	34,071	2002108
AMK 900D	900	2.00 mm	39,863	2002109
AMK 1000D	1.000	2.00 mm	46,639	2002108

W = GENİŞLİK = WIDTH / T = KALINLIK = THICKNESS

- * Farklı kalınlık ve ölçülerde üretim yapıla bilinir.
- * Malzeme ağırlıkları yaklaşık değerlerdir, ± %10 değişiklik gösterebilir.
- * Malzeme kalınlık toleransı ± %10 dur.
- * Lütfen siparişlerinizde sipariş kodu veya ürün kodu ve Kaplama şeklini belirtiniz.

- * We can produce cable trays different thickness and dimensions
- * Cable trays are shown approximately weight, they could chande ± %10 difference.
- * Cable trays thickness tolerances are shown ± %10 .
- * Please indicate order code and coating type in your orders.

AKK SERIES

KAPAK TUTUCU (VİDASIZ)

COVER CLAMP WITHOUT SCREW

PREGALVANİZ (PG)
PREGALVANIZED (PG)
TS EN 10346



Sipariş Kodu Order Code	H (mm)	T (mm)	Ağırlık (kg/ad) Weight (kg/pcs)	Barkod Kodu Barcode Code
AKT-4	40 mm	1.50 mm	0,025	2001545

H40

Sipariş Kodu Order Code	H (mm)	T (mm)	Ağırlık (kg/ad) Weight (kg/pcs)	Barkod Kodu Barcode Code
AKT-5	50 mm	1.50 mm	0,030	2001546

H50

Sipariş Kodu Order Code	H (mm)	T (mm)	Ağırlık (kg/ad) Weight (kg/pcs)	Barkod Kodu Barcode Code
AKT-6	60 mm	1.50 mm	0,032	2001547

H60

Sipariş Kodu Order Code	H (mm)	T (mm)	Ağırlık (kg/ad) Weight (kg/pcs)	Barkod Kodu Barcode Code
AKT-7	70 mm	1.50 mm	0,034	2001548

H75

Sipariş Kodu Order Code	H (mm)	T (mm)	Ağırlık (kg/ad) Weight (kg/pcs)	Barkod Kodu Barcode Code
AKT-10	100 mm	1.50 mm	0,050	2001549

H100

Sipariş Kodu Order Code	H (mm)	T (mm)	Ağırlık (kg/ad) Weight (kg/pcs)	Barkod Kodu Barcode Code
AKT-15	150 mm	1.50 mm	0,081	2001550

H150

H = YÜKSEKLİK = HEIGHT / T = KALINLIK = THICKNESS

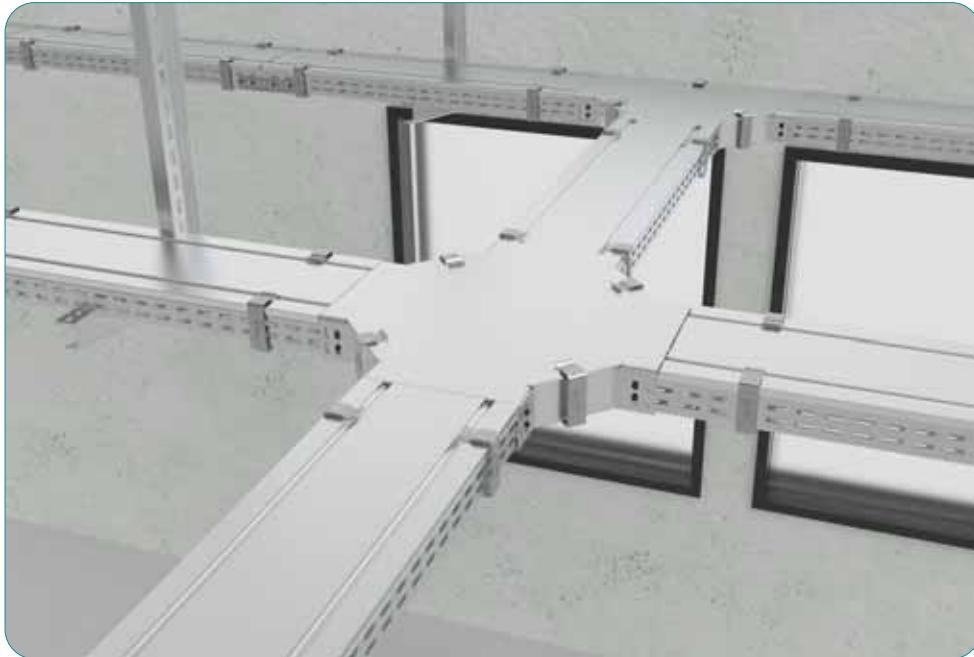
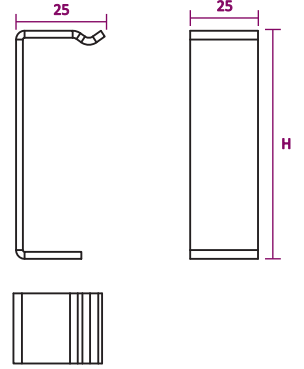

ARTIM METAL ELEKTRİK A.Ş.

- * Farklı kalınlık ve ölçülerde üretim yapılabılır.
- * Malzeme ağırlıkları yaklaşık değerlerdir, \pm %10 değişiklik gösterebilir.
- * Malzeme kalınlık toleransı \pm %10 dur.
- * Lütfen siparişlerinizde sipariş kodu veya ürün kodu ve Kaplama şeklini belirtiniz.

- * We can produce cable trays different thickness and dimensions
- * Cable trays are shown approximately weight, they could change \pm %10 difference.
- * Cable trays thickness tolerances are shown \pm %10 .
- * Please indicate order code and coating type in your orders.

art

POWER CARRYING SOLUTIONS



TEL ÖRGÜ KABLO KANALLARI

WIREMESH CABLE TRAYS

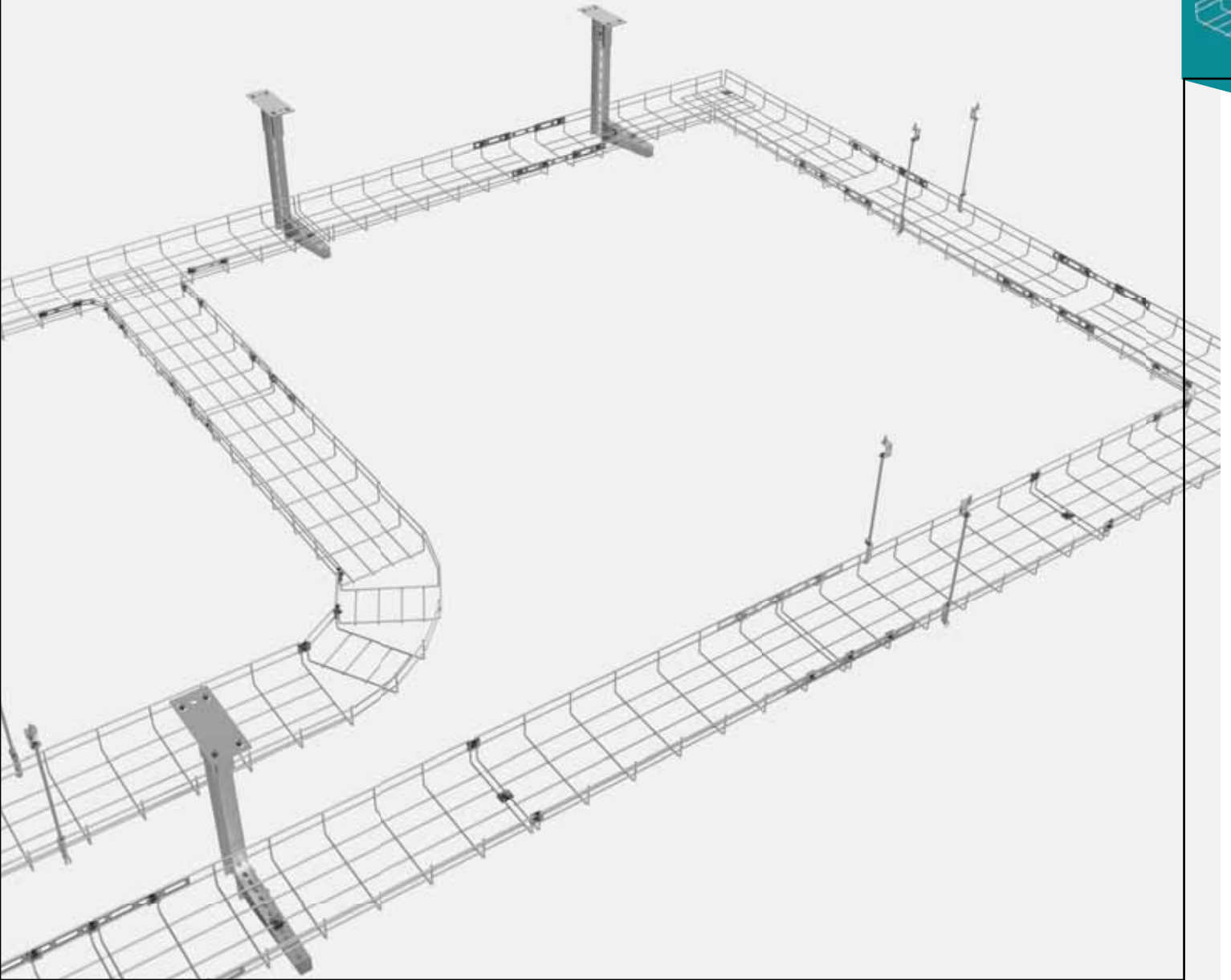

ART SERIES

H35 TEL ÖRGÜ KABLO KANALI

H35 WIREMESH CABLE TRAYS

ELEKTRO GALVANİZ (EG)
ELECTRO GALVANIZED (EG)
TS 149

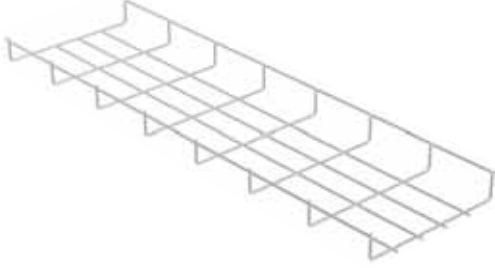

H35 = Tek Sıra Tel
H35 = Single Row Wire

Q4

Sipariş Kodu Order Code	W (mm)	T (mm)	Ağırlık (kg/m) Weight (kg/m)	Barkod Kodu Barcode Code
35 ART 050	50	Q4	0,497	2004000
35 ART 100	100	Q4	0,523	2004001
35 ART 150	150	Q4	0,665	2004002
35 ART 200	200	Q4	0,808	2004003
35 ART 250	250	Q4	0,951	2004004
35 ART 300	300	Q4	1,093	2004005
35 ART 400	400	Q4	1,378	2004006
35 ART 500	500	Q4	1,664	2004007
35 ART 600	600	Q4	1,949	2004008

Q5

Sipariş Kodu Order Code	W (mm)	T (mm)	Ağırlık (kg/m) Weight (kg/m)	Barkod Kodu Barcode Code
35 ART 050	50	Q5	0,621	2004009
35 ART 100	100	Q5	0,941	2004010
35 ART 150	150	Q5	1,197	2004011
35 ART 200	200	Q5	1,454	2004012
35 ART 250	250	Q5	1,721	2004013
35 ART 300	300	Q5	1,967	2004014
35 ART 400	400	Q5	2,480	2004015
35 ART 500	500	Q5	2,995	2004016
35 ART 600	600	Q5	3,508	2004017

H = YÜKSEKLİK = HEIGHT / W = GENİŞLİK = WIDTH / T = KALINLIK = THICKNESS

35 ART 100- 4

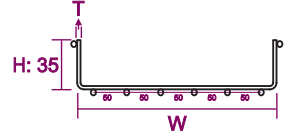

W 050 = Tek Sıra Tel
W 100 = İki Sıra Tel
W 150 = Üç Sıra Tel
W 200 = Dört Sıra Tel
W 250 = Bes Sıra Tel
W 300 = Altı Sıra Tel
W 400 = Sekiz Sıra Tel
W 500 = On Sıra Tel
W 600 = On iki Sıra Tel

W 050 = Single Row Wire
W 100 = Two Rows of Wire
W 150 = Three Row Wire
W 200 = Four Row Wire
W 250 = Five Row Wires
W 300 = Six Row Wire
W 400 = Eight Row Wire
W 500 = Ten Row Wires
W 600 = Twelve Row Wires

Standart uzunluk L:3000 mm
Toplu miktarlarda Özel ölçüler yapılabilir.
Standard Length L:3000 mm
Custom sizes can be made in bulk quantities.

SICAK DALDIRMA (SD)
HOT DIP GALVANIZED (SD)
TS EN ISO 1461

Q4

Sipariş Kodu Order Code	W (mm)	T (mm)	Ağırlık (kg/m) Weight (kg/m)	Barkod Kodu Barcode Code
35 ART 050	50	Q4	0,542	2004000
35 ART 100	100	Q4	0,570	2004001
35 ART 150	150	Q4	0,725	2004002
35 ART 200	200	Q4	0,881	2004003
35 ART 250	250	Q4	1,037	2004004
35 ART 300	300	Q4	1,191	2004005
35 ART 400	400	Q4	1,502	2004006
35 ART 500	500	Q4	1,814	2004007
35 ART 600	600	Q4	2,124	2004008

Q5

Sipariş Kodu Order Code	W (mm)	T (mm)	Ağırlık (kg/m) Weight (kg/m)	Barkod Kodu Barcode Code
35 ART 050	50	Q5	0,677	2004009
35 ART 100	100	Q5	1,026	2004010
35 ART 150	150	Q5	1,305	2004011
35 ART 200	200	Q5	1,585	2004012
35 ART 250	250	Q5	1,876	2004013
35 ART 300	300	Q5	2,144	2004014
35 ART 400	400	Q5	2,703	2004015
35 ART 500	500	Q5	3,265	2004016
35 ART 600	600	Q5	3,824	2004017

H = YÜKSEKLİK = HEIGHT / W = GENİŞLİK = WIDTH / T = KALINLIK = THICKNESS

ARTIM METAL ELEKTRİK A.Ş.

* Farklı kalınlık ve ölçülerde üretim yapılabılır.
* Malzeme ağırlıkları yaklaşık değerlerdir, \pm %10 değişiklik gösterebilir.
* Malzeme kalınlık toleransı \pm %10 dur.
* Lütfen siparişlerinizde sipariş kodu veya ürün kodu ve Kaplama şeklini belirtiniz.

* We can produce cable trays different thickness and dimensions
* Cable trays are shown approximately weight, they could change \pm %10 difference.
* Cable trays thickness tolerances are shown \pm %10 .
* Please indicate order code and coating type in your orders.

ART SERIES

H50 TEL ÖRGÜ KABLO KANALI

H50 WIREMESH CABLE TRAYS

ELEKTRO GALVANİZ (EG)

ELECTRO GALVANIZED (EG)

TS 149

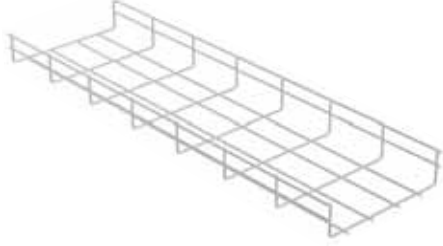

H50 = İki Sıra Tel
H50 = Two Rows of Wire

SICAK DALDIRMA (SD)

HOT DIP GALVANIZED (SD)

TS EN ISO 1461

Q4

Sipariş Kodu Order Code	W (mm)	T (mm)	Ağırlık (kg/m) Weight (kg/m)	Barkod Kodu Barcode Code
50 ART 050	50	Q4	0,650	2004020
50 ART 100	100	Q4	0,800	2004021
50 ART 150	150	Q4	0,950	2004022
50 ART 200	200	Q4	1,105	2004023
50 ART 250	250	Q4	1,249	2004024
50 ART 300	300	Q4	1,402	2004025
50 ART 400	400	Q4	1,713	2004026
50 ART 500	500	Q4	2,012	2004027
50 ART 600	600	Q4	2,324	2004028

Q5

Sipariş Kodu Order Code	W (mm)	T (mm)	Ağırlık (kg/m) Weight (kg/m)	Barkod Kodu Barcode Code
50 ART 050	50	Q5	0,812	2004029
50 ART 100	100	Q5	1,110	2004030
50 ART 150	150	Q5	1,330	2004031
50 ART 200	200	Q5	1,560	2004032
50 ART 250	250	Q5	1,780	2004033
50 ART 300	300	Q5	1,998	2004034
50 ART 400	400	Q5	2,432	2004035
50 ART 500	500	Q5	2,862	2004036
50 ART 600	600	Q5	3,292	2004037

H = YÜKSEKLİK = HEIGHT / W = GENİŞLİK = WIDTH / T = KALINLIK = THICKNESS

Q4

Sipariş Kodu Order Code	W (mm)	T (mm)	Ağırlık (kg/m) Weight (kg/m)	Barkod Kodu Barcode Code
50 ART 050	50	Q4	0,709	2004020
50 ART 100	100	Q4	0,872	2004021
50 ART 150	150	Q4	1,036	2004022
50 ART 200	200	Q4	1,204	2004023
50 ART 250	250	Q4	1,361	2004024
50 ART 300	300	Q4	1,528	2004025
50 ART 400	400	Q4	1,867	2004026
50 ART 500	500	Q4	2,193	2004027
50 ART 600	600	Q4	2,533	2004028

Q5

Sipariş Kodu Order Code	W (mm)	T (mm)	Ağırlık (kg/m) Weight (kg/m)	Barkod Kodu Barcode Code
50 ART 050	50	Q5	0,885	2004029
50 ART 100	100	Q5	1,210	2004030
50 ART 150	150	Q5	1,450	2004031
50 ART 200	200	Q5	1,700	2004032
50 ART 250	250	Q5	1,940	2004033
50 ART 300	300	Q5	2,178	2004034
50 ART 400	400	Q5	2,651	2004035
50 ART 500	500	Q5	3,120	2004036
50 ART 600	600	Q5	3,588	2004037

H = YÜKSEKLİK = HEIGHT / W = GENİŞLİK = WIDTH / T = KALINLIK = THICKNESS

50 ART 100- 4

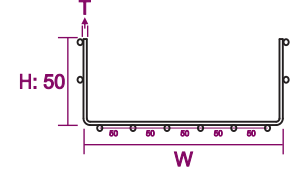

W 050 = Tek Sıra Tel
W 100 = İki Sıra Tel
W 150 = Üç Sıra Tel
W 200 = Dört Sıra Tel
W 250 = Bes Sıra Tel
W 300 = Altı Sıra Tel
W 400 = Sekiz Sıra Tel
W 500 = On Sıra Tel
W 600 = On iki Sıra Tel

W 050 = Single Row Wire
W 100 = Two Rows of Wire
W 150 = Three Row Wire
W 200 = Four Row Wire
W 250 = Five Row Wires
W 300 = Six Row Wire
W 400 = Eight Row Wire
W 500 = Ten Row Wires
W 600 = Twelve Row Wires

Standart uzunluk L:3000 mm

Toplu miktarlarda Özel ölçüler yapılabilir.
Standard Length L:3000 mm
Custom sizes can be made in bulk quantities.

* Farklı kalınlık ve ölçülerde üretim yapılabılır.
* Malzeme ağırlıkları yaklaşık değerlerdir, ± %10 değişiklik gösterebilir.
* Malzeme kalınlık toleransı ± %10 dur.
* Lütfen siparişlerinizde sipariş kodu veya ürün kodu ve Kaplama şeklini belirtiniz.

* We can produce cable trays different thickness and dimensions
* Cable trays are shown approximately weight, they could change ± %10 difference.
* Cable trays thickness tolerances are shown ± %10 .
* Please indicate order code and coating type in your orders.

ART SERIES

H85 TEL ÖRGÜ KABLO KANALI

H85 WIREMESH CABLE TRAYS

ELEKTRO GALVANİZ (EG)
ELECTRO GALVANIZED (EG)
TS 149

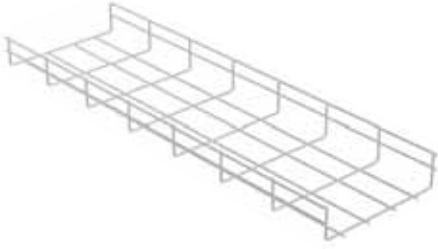

H85 = İki Sıra Tel
H85 = Two Rows of Wire

Q4

Sipariş Kodu Order Code	W (mm)	T (mm)	Ağırlık (kg/m) Weight (kg/m)	Barkod Kodu Barcode Code
85 ART 100	100	Q4	0,808	2004041
85 ART 150	150	Q4	0,951	2004042
85 ART 200	200	Q4	1,093	2004043
85 ART 250	250	Q4	1,236	2004044
85 ART 300	300	Q4	1,378	2004045
85 ART 400	400	Q4	1,664	2004046
85 ART 500	500	Q4	1,949	2004047
85 ART 600	600	Q4	2,238	2004048

Q5

Sipariş Kodu Order Code	W (mm)	T (mm)	Ağırlık (kg/m) Weight (kg/m)	Barkod Kodu Barcode Code
85 ART 100	100	Q5	1,483	2004049
85 ART 150	150	Q5	1,746	2004050
85 ART 200	200	Q5	2,007	2004051
85 ART 250	250	Q5	2,117	2004052
85 ART 300	300	Q5	2,269	2004053
85 ART 400	400	Q5	2,554	2004054
85 ART 500	500	Q5	2,991	2004055
85 ART 600	600	Q5	3,428	2004056

H = YÜKSEKLİK = HEIGHT / W = GENİŞLİK = WIDTH / T = KALINLIK = THICKNESS

85 ART 100- 4

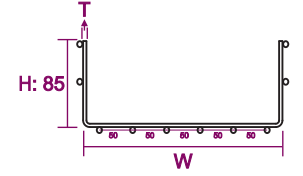

W 100 = İki Sıra Tel
W 150 = Üç Sıra Tel
W 200 = Dört Sıra Tel
W 250 = Bes Sıra Tel
W 300 = Altı Sıra Tel
W 400 = Sekiz Sıra Tel
W 500 = On Sıra Tel
W 600 = On iki Sıra Tel

W 100 = Two Rows of Wire
W 150 = Three Row Wire
W 200 = Four Row Wire
W 250 = Five Row Wires
W 300 = Six Row Wire
W 400 = Eight Row Wire
W 500 = Ten Row Wires
W 600 = Twelve Row Wires

Standart uzunluk L:3000 mm
Toplu miktarlarda Özel ölçüler yapılabilir.
Standard Length L:3000 mm
Custom sizes can be made in bulk quantities.

SICAK DALDIRMA (SD)
HOT DIP GALVANIZED (SD)
TS EN ISO 1461

Q4

Sipariş Kodu Order Code	W (mm)	T (mm)	Ağırlık (kg/m) Weight (kg/m)	Barkod Kodu Barcode Code
85 ART 100	100	Q4	0,881	2004041
85 ART 150	150	Q4	1,037	2004042
85 ART 200	200	Q4	1,191	2004043
85 ART 250	250	Q4	1,347	2004044
85 ART 300	300	Q4	1,502	2004045
85 ART 400	400	Q4	1,814	2004046
85 ART 500	500	Q4	2,124	2004047
85 ART 600	600	Q4	2,439	2004048

Q5

Sipariş Kodu Order Code	W (mm)	T (mm)	Ağırlık (kg/m) Weight (kg/m)	Barkod Kodu Barcode Code
85 ART 100	100	Q5	1,616	2004049
85 ART 150	150	Q5	1,903	2004050
85 ART 200	200	Q5	2,188	2004051
85 ART 250	250	Q5	2,308	2004052
85 ART 300	300	Q5	2,473	2004053
85 ART 400	400	Q5	2,784	2004054
85 ART 500	500	Q5	3,260	2004055
85 ART 600	600	Q5	3,737	2004056

H = YÜKSEKLİK = HEIGHT / W = GENİŞLİK = WIDTH / T = KALINLIK = THICKNESS

ARTIM METAL ELEKTRİK A.Ş.

* Farklı kalınlık ve ölçülerde üretim yapılabılır.
* Malzeme ağırlıkları yaklaşık değerlerdir, ± %10 değişiklik gösterebilir.
* Malzeme kalınlık toleransı ± %10 dur.
* Lütfen siparişlerinizde sipariş kodu veya ürün kodu ve Kaplama şeklini belirtiniz.

* We can produce cable trays different thickness and dimensions
* Cable trays are shown approximately weight, they could change ± %10 difference.
* Cable trays thickness tolerances are shown ± %10 .
* Please indicate order code and coating type in your orders.

ART SERIES

H100 TEL ÖRGÜ KABLO KANALI

H100 WIREMESH CABLE TRAYS

ELEKTRO GALVANİZ (EG)

ELECTRO GALVANIZED (EG)

TS 149



H100 = Üç Sıra Tel
H100 = Three Row Wire

Q4

Sipariş Kodu Order Code	W (mm)	T (mm)	Ağırlık (kg/m) Weight (kg/m)	Barkod Kodu Barcode Code
100 ART 100	100	Q4	1,050	2004060
100 ART 150	150	Q4	1,118	2004061
100 ART 200	200	Q4	1,331	2004062
100 ART 250	250	Q4	1,474	2004063
100 ART 300	300	Q4	1,616	2004064
100 ART 400	400	Q4	1,901	2004065
100 ART 500	500	Q4	2,187	2004066
100 ART 600	600	Q4	2,482	2004067

Q5

Sipariş Kodu Order Code	W (mm)	T (mm)	Ağırlık (kg/m) Weight (kg/m)	Barkod Kodu Barcode Code
100 ART 100	100	Q5	1,890	2004068
100 ART 150	150	Q5	2,012	2004069
100 ART 200	200	Q5	2,396	2004070
100 ART 250	250	Q5	2,485	2004071
100 ART 300	300	Q5	2,652	2004072
100 ART 400	400	Q5	2,922	2004073
100 ART 500	500	Q5	3,359	2004074
100 ART 600	600	Q5	3,796	2004075

H = YÜKSEKLİK = HEIGHT / W = GENİŞLİK = WIDTH / T = KALINLIK = THICKNESS

100 ART 100- 4

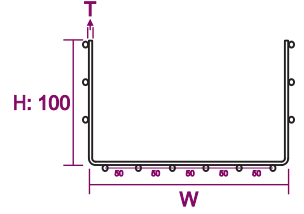

W 100 = İki Sıra Tel
W 150 = Üç Sıra Tel
W 200 = Dört Sıra Tel
W 250 = Bes Sıra Tel
W 300 = Altı Sıra Tel
W 400 = Sekiz Sıra Tel
W 500 = On Sıra Tel
W 600 = On iki Sıra Tel

W 100 = Two Rows of Wire
W 150 = Three Row Wire
W 200 = Four Row Wire
W 250 = Five Row Wires
W 300 = Six Row Wire
W 400 = Eight Row Wire
W 500 = Ten Row Wires
W 600 = Twelve Row Wires

Standart uzunluk L:3000 mm
Toplu miktarlarda Özel ölçüler yapılabilir.
Standard Length L:3000 mm
Custom sizes can be made in bulk quantities.

SICAK DALDIRMA (SD)

HOT DIP GALVANIZED (SD)

TS EN ISO 1461

Q4

Sipariş Kodu Order Code	W (mm)	T (mm)	Ağırlık (kg/m) Weight (kg/m)	Barkod Kodu Barcode Code
100 ART 100	100	Q4	1,145	2004060
100 ART 150	150	Q4	1,219	2004061
100 ART 200	200	Q4	1,451	2004062
100 ART 250	250	Q4	1,607	2004063
100 ART 300	300	Q4	1,761	2004064
100 ART 400	400	Q4	2,072	2004065
100 ART 500	500	Q4	2,384	2004066
100 ART 600	600	Q4	2,705	2004067

Q5

Sipariş Kodu Order Code	W (mm)	T (mm)	Ağırlık (kg/m) Weight (kg/m)	Barkod Kodu Barcode Code
100 ART 100	100	Q5	2,060	2004068
100 ART 150	150	Q5	2,193	2004069
100 ART 200	200	Q5	2,612	2004070
100 ART 250	250	Q5	2,891	2004071
100 ART 300	300	Q5	2,709	2004072
100 ART 400	400	Q5	3,185	2004073
100 ART 500	500	Q5	3,661	2004074
100 ART 600	600	Q5	4,138	2004075

H = YÜKSEKLİK = HEIGHT / W = GENİŞLİK = WIDTH / T = KALINLIK = THICKNESS

* Farklı kalınlık ve ölçülerde üretim yapılabılır.
* Malzeme ağırlıkları yaklaşık değerlerdir, ± %10 değişiklik gösterebilir.
* Malzeme kalınlık toleransı ± %10 dur.
* Lütfen siparişlerinizde sipariş kodu veya ürün kodu ve Kaplama şeklini belirtiniz.

* We can produce cable trays different thickness and dimensions
* Cable trays are shown approximately weight, they could change ± %10 difference.
* Cable trays thickness tolerances are shown ± %10 .
* Please indicate order code and coating type in your orders.

ART SERIES

TEL ÖRGÜ KANAL BAĞLANTILARI

WIRE MESH CABLE TRAY CONNECTIONS

PREGALVANİZ (PG)
PREGALVANIZED (PG)
TS EN 10346



BİRLEŞTİRME ELEMANI / CONNECTOR

Sipariş Kodu Order Code	Ebat (mm) Size (mm)	T (mm)	Ağırlık (kg/ad) Weight (kg/pcs)	Barkod Kodu Barcode Code
ART-6-1B	30	2.50 mm	0,012	2004101
ART-6-1K	25	2.50 mm	0,010	2004102

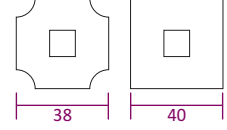

Her bir ürüne 1 adet M6x15 Civata ve 1 adet M6 Somun kullanılmaktadır. Ayrı satılmaktadır.
1 M6x15 Bolt and 1 M6 Nut are used for each product. It is sold separately.

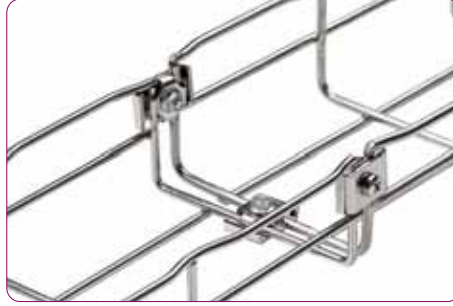

Kanal ebatlarına göre önerilen bağlantı adetleri
/ Recommended connection sizes according to channel sizes

W (mm)	H35/H50	H85/H100
50	2	-
100	2	2+1
150	2	2+1
200	2+1	2+2
250	2+1	2+2
300	2+2	2+3
400	2+2	2+3
500	2+2	2+3
600	2+2	2+3

H = YÜKSEKLİK = HEIGHT / W = GENİŞLİK = WIDTH

PREGALVANİZ (PG)
PREGALVANIZED (PG)
TS EN 10346



BİRLEŞTİRME ELEMANI / CONNECTOR

Sipariş Kodu Order Code	Ebat (mm) Size (mm)	T (mm)	Ağırlık (kg/ad) Weight (kg/pcs)	Barkod Kodu Barcode Code
ART-6-1K	25	2.50 mm	0,010	2004102

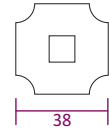

Her bir ürüne 1 adet M6x15 Civata ve 1 adet M6 Somun kullanılmaktadır. Ayrı satılmaktadır.
1 M6x15 Bolt and 1 M6 Nut are used for each product. It is sold separately.

Kanal ebatlarına göre önerilen sabitleme adetleri / Fixing pieces recommended according to tray sizes

W (mm)	ad/pcs
50	1
100	1
150	1
200	2
250	2
300	2
400	2
500	2
600	2

W = GENİŞLİK = WIDTH

ARTIM METAL ELEKTRİK A.Ş.

- * Farklı kalınlık ve ölçülerde üretim yapılabılır.
- * Malzeme ağırlıkları yaklaşık değerlerdir, \pm %10 değişiklik gösterebilir.
- * Malzeme kalınlık toleransı \pm %10 dur.
- * Lütfen siparişlerinizde sipariş kodu veya ürün kodu ve Kaplama şeklini belirtiniz.

- * We can produce cable trays different thickness and dimensions
- * Cable trays are shown approximately weight, they could change \pm %10 difference.
- * Cable trays thickness tolerances are shown \pm %10 .
- * Please indicate order code and coating type in your orders.

ART SERIES

TEL ÖRGÜ KANAL BAĞLANTILARI

WIRE MESH CABLE TRAY CONNECTIONS

PREGALVANİZ (PG)
PREGALVANIZED (PG)
TS EN 10346

HIZLI BİRLEŞTİRME / BOLTLESS QUICK

Sipariş Kodu Order Code	Ebat (mm) Size (mm)	T (mm)	Ağırlık (kg/ad) Weight (kg/pcs)	Barkod Kodu Barcode Code
ART-8	220X18	1.20 mm	0,090	2004100

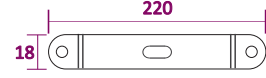

H50 / H85 / H100 Kanalları birleştirme için kullanılır.
H50 / H85 / H100 Used for joining trays.

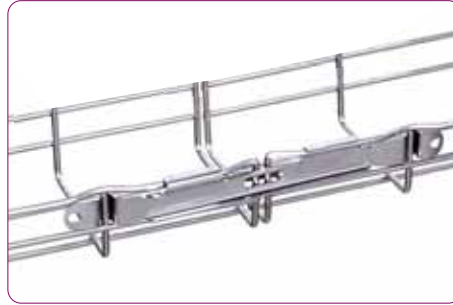

PREGALVANİZ (PG)
PREGALVANIZED (PG)
TS EN 10346

BİRLEŞTİRME ELEMANI / CONNECTOR

Sipariş Kodu Order Code	Ebat (mm) Size (mm)	T (mm)	Ağırlık (kg/ad) Weight (kg/pcs)	Barkod Kodu Barcode Code
ART-5-1	300	2.00 mm	0,012	2004121
ART-5-2	350	2.00 mm	0,010	2004122
ART-5-3	400	2.00 mm	0,012	2004123
ART-5-4	450	2.00 mm	0,010	2004124
ART-5-5	500	2.00 mm	0,012	2004125
ART-5-6	550	2.00 mm	0,010	2004126
ART-5-7	600	2.00 mm	0,012	2004127



Düz birleştirme, Redüksiyon birleştirme
Dereceli birleştirme olarak kullanılır.
It is used as straight connector, reduction
connector, graded connector.

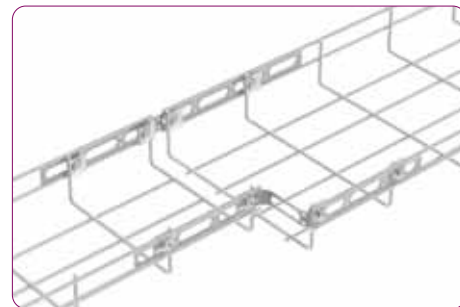
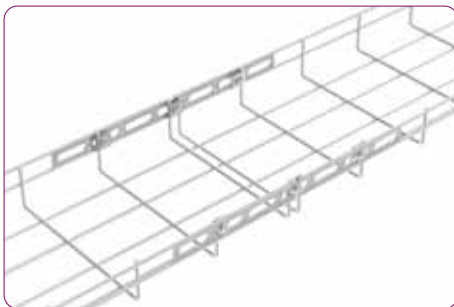

* Farklı kalınlık ve ölçülerde üretim yapılabılır.
* Malzeme ağırlıkları yaklaşık değerlerdir, \pm %10 değişiklik gösterebilir.
* Malzeme kalınlık toleransı \pm %10 dur.
* Lütfen siparişlerinizde sipariş kodu veya ürün kodu ve Kaplama şeklini belirtiniz.

* We can produce cable trays different thickness and dimensions
* Cable trays are shown approximately weight, they could change \pm %10 difference.
* Cable trays thickness tolerances are shown \pm %10 .
* Please indicate order code and coating type in your orders.

ART SERIES

TEL ÖRGÜ KANAL BAĞLANTILARI

WIRE MESH CABLE TRAY CONNECTIONS

PREGALVANIZ (PG)
PREGALVANIZED (PG)
TS EN 10346

TİJLİ KANAL TAŞIYICI / TRAY CARRIERS WHICH USED THREADED ROD

Sipariş Kodu Order Code	Ebat (mm) Size (mm)	T (mm)	Ağırlık (kg/ad) Weight (kg/pcs)	Barkod Kodu Barcode Code
ART-11	60x35	2.00 mm	0,030	2004103

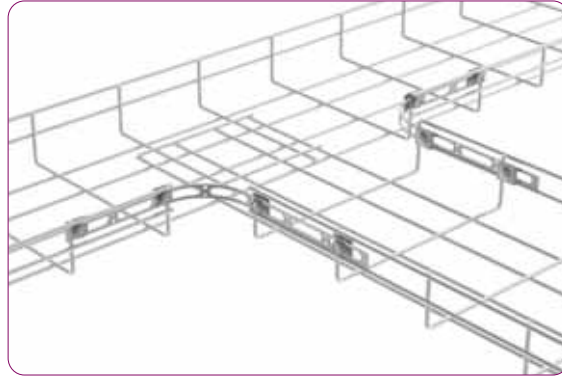
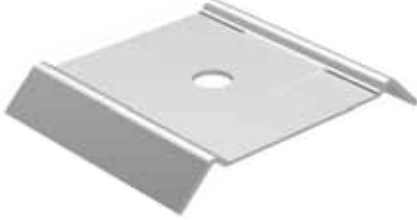
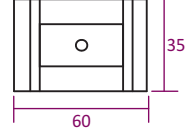

PREGALVANIZ (PG)
PREGALVANIZED (PG)
TS EN 10346

TİJLİ KANAL TAŞIYICI / TRAY CARRIERS WHICH USED THREADED ROD

Sipariş Kodu Order Code	Ebat (mm) Size (mm)	T (mm)	Ağırlık (kg/ad) Weight (kg/pcs)	Barkod Kodu Barcode Code
ART-16	110x45	2.00 mm	0,080	2004105

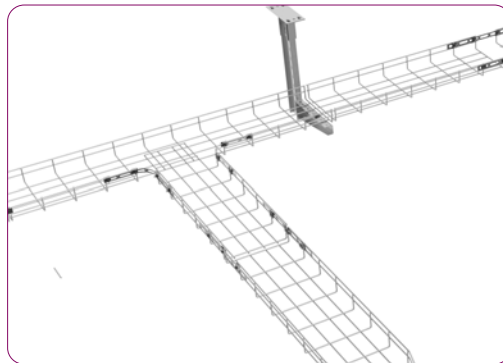
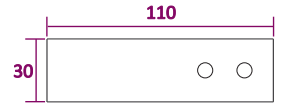
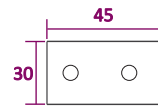

ARTIM METAL ELEKTRİK A.Ş.

- * Farklı kalınlık ve ölçülerde üretim yapılabılır.
- * Malzeme ağırlıkları yaklaşık değerlerdir, \pm %10 değişiklik gösterebilir.
- * Malzeme kalınlık toleransı \pm %10 dur.
- * Lütfen siparişlerinizde sipariş kodu veya ürün kodu ve Kaplama şeklini belirtiniz.

- * We can produce cable trays different thickness and dimensions
- * Cable trays are shown approximately weight, they could change \pm %10 difference.
- * Cable trays thickness tolerances are shown \pm %10 .
- * Please indicate order code and coating type in your orders.

ART SERIES

TEL ÖRGÜ KANAL BAĞLANTILARI

WIRE MESH CABLE TRAY CONNECTIONS

PREGALVANİZ (PG)
PREGALVANIZED (PG)
TS EN 10346

TIRNAKLI DUVAR TESPİT ELEMANI / FIXING ELEMENT FOR WALL MOUNTING

Sipariş Kodu Order Code	Ebat (mm) Size (mm)	T (mm)	Ağırlık (kg/ad) Weight (kg/pcs)	Barkod Kodu Barcode Code
ART-13	113x30	1.50 mm	0,050	2004104

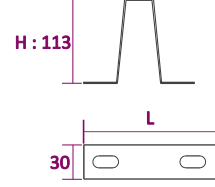

DUVAR KONSOLU / BRACKETS FOR MOUNTING

Sipariş Kodu Order Code	Ebat (mm) Size (mm)	T (mm)	Ağırlık (kg/ad) Weight (kg/pcs)	Barkod Kodu Barcode Code
ARTT 050	130	1.50 mm	0,164	2004131
ARTT 100	130	1.50 mm	0,240	2004132
ARTT 150	180	1.50 mm	0,260	2004133
ARTT 200	230	1.50 mm	0,330	2004134

PREGALVANİZ (PG)
PREGALVANIZED (PG)
TS EN 10346

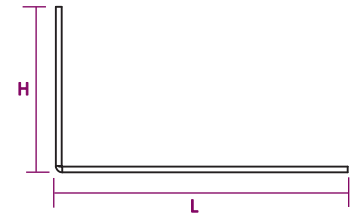

* Farklı kalınlık ve ölçülerde üretim yapılabılır.
* Malzeme ağırlıkları yaklaşık değerlerdir, \pm %10 değişiklik gösterebilir.
* Malzeme kalınlık toleransı \pm %10 dur.
* Lütfen siparişlerinizde sipariş kodu veya ürün kodu ve kaplama şeklini belirtiniz.

* We can produce cable trays different thickness and dimensions
* Cable trays are shown approximately weight, they could change \pm %10 difference.
* Cable trays thickness tolerances are shown \pm %10 .
* Please indicate order code and coating type in your orders.

ART SERIES

TEL ÖRGÜ KANAL BAĞLANTILARI

WIRE MESH CABLE TRAY CONNECTIONS

PREGALVANİZ (PG)
PREGALVANIZED (PG)
TS EN 10346

KABLO İNİŞ ELEMANI / CABLE GUIDER

Sipariş Kodu Order Code	Ebat (mm) Size (mm)	T (mm)	Ağırlık (kg/ad) Weight (kg/pcs)	Barkod Kodu Barcode Code
ART-7	80x170	2.00 mm	0,150	2004107

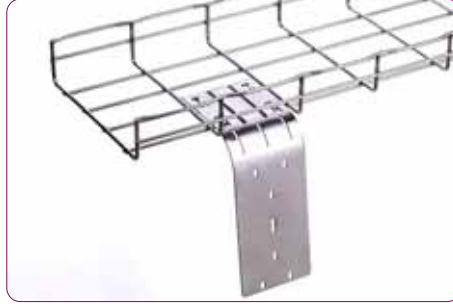
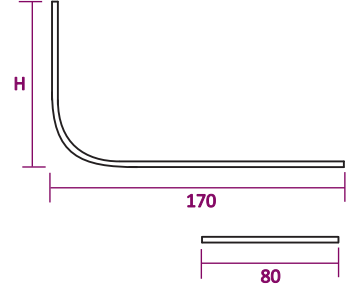

PREGALVANİZ (PG)
PREGALVANIZED (PG)
TS EN 10346

KANAL TAŞIYICI / TRAY CARRIERS

Sipariş Kodu Order Code	Ebat (mm) Size (mm)	T (mm)	Ağırlık (kg/ad) Weight (kg/pcs)	Barkod Kodu Barcode Code
ART-9	25x52	4.00 mm	0,079	2004108

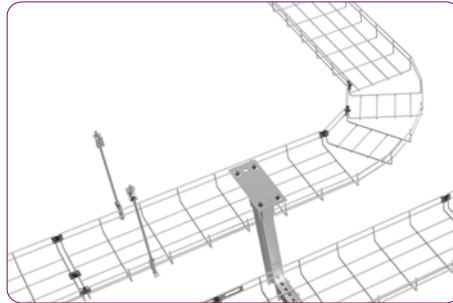
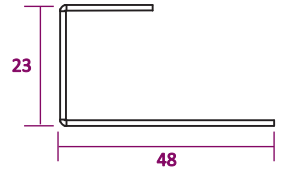

ARTIM METAL ELEKTRİK A.Ş.

- * Farklı kalınlık ve ölçülerde üretim yapılabılır.
- * Malzeme ağırlıkları yaklaşık değerlerdir, \pm %10 değişiklik gösterebilir.
- * Malzeme kalınlık toleransı \pm %10 dur.
- * Lütfen siparişlerinizde sipariş kodu veya ürün kodu ve Kaplama şeklini belirtiniz.

- * We can produce cable trays different thickness and dimensions
- * Cable trays are shown approximately weight, they could change \pm %10 difference.
- * Cable trays thickness tolerances are shown \pm %10 .
- * Please indicate order code and coating type in your orders.

ART SERIES

TEL ÖRGÜ KANAL BAĞLANTILARI

WIRE MESH CABLE TRAY CONNECTIONS

PIRİNÇ
BRASS
TS 564

TOPRAKLAMA ELEMANI / EARTHING PART

Sipariş Kodu Order Code	Ebat (mm) Size (mm)	Ağırlık (kg/ad) Weight (kg/pcs)	Barkod Kodu Barcode Code
TP-1	M6	0,030	2004141

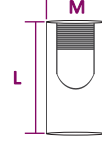
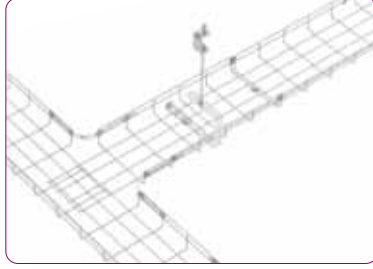

TOPRAKLAMA ELEMANI / EARTHING PART

Sipariş Kodu Order Code	Ebat (mm) Size (mm)	Ağırlık (kg/ad) Weight (kg/pcs)	Barkod Kodu Barcode Code
TP-2	16x16	0,032	2004142

PIRİNÇ
BRASS
TS 564

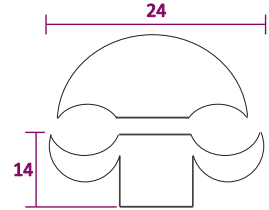

ÖRGÜLÜ BAKIR BARA / COPPER CONNECTORS

Sipariş Kodu Order Code	Ebat (mm) Size (mm)	Ağırlık (kg/ad) Weight (kg/pcs)	Barkod Kodu Barcode Code
TP-3	12x82	0,008	2004143

BAKIR
COPPER



* Farklı kalınlık ve ölçülerde üretim yapılabılır.
* Malzeme ağırlıkları yaklaşık değerlerdir, \pm %10 değişiklik gösterebilir.
* Malzeme kalınlık toleransı \pm %10 dur.
* Lütfen siparişlerinizde sipariş kodu veya ürün kodu ve kaplama şeklini belirtiniz.

* We can produce cable trays different thickness and dimensions
* Cable trays are shown approximately weight, they could change \pm %10 difference.
* Cable trays thickness tolerances are shown \pm %10 .
* Please indicate order code and coating type in your orders.

ART SERIES

TEL ÖRGÜ KANAL BAĞLANTILARI

WIRE MESH CABLE TRAY CONNECTIONS

TEL KANAL NASIL KESİLİR ?

HOW TO CUT WIRE MESH CABLE TRAY?

1.ALT TELLERİ KES / SUB WIRES CUT

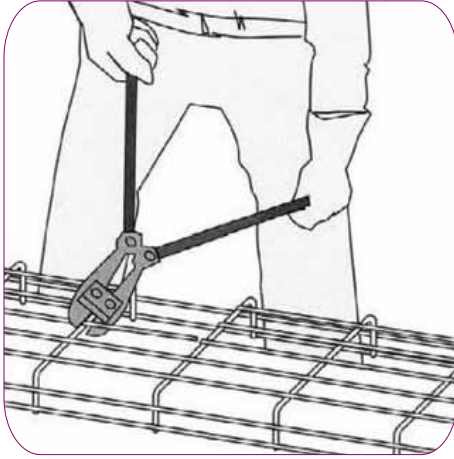

2.KESME SIRALAMASI / CUTTING ORDER

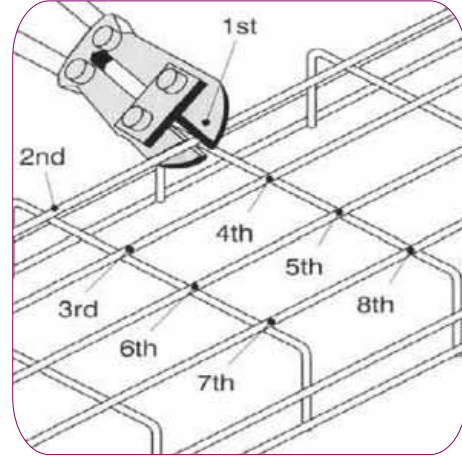

3.YAN KENAR ÜST TELLERİ KES / SIDE EDGE UPPER WIRES CUT

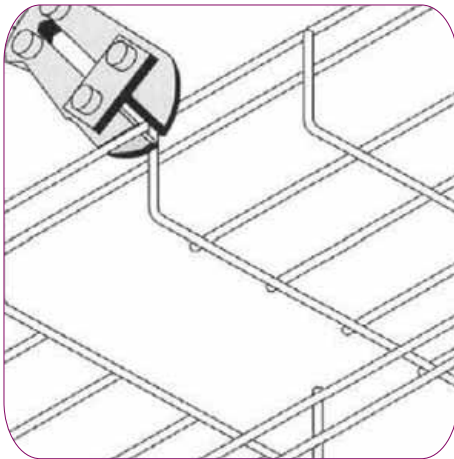

4.YAN KENAR ALT TELLERİ KES / SIDE EDGE LOWER WIRES CUT

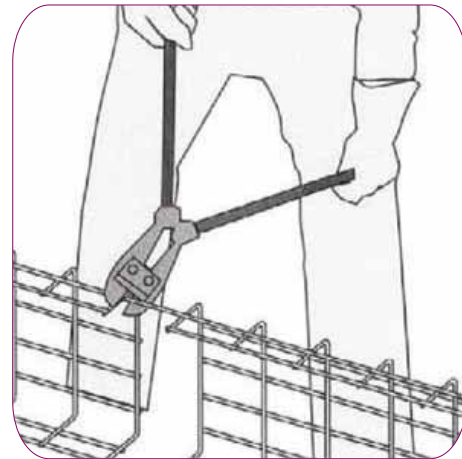

ARTIM METAL ELEKTRİK A.Ş.

- * Farklı kalınlık ve ölçülerde üretim yapılabılır.
- * Malzeme ağırlıkları yaklaşık değerlerdir, \pm %10 değişiklik gösterebilir.
- * Malzeme kalınlık toleransı \pm %10 dur.
- * Lütfen siparişlerinizde sipariş kodu veya ürün kodu ve kaplama şeklini belirtiniz.

- * We can produce cable trays different thickness and dimensions
- * Cable trays are shown approximately weight, they could change \pm %10 difference.
- * Cable trays thickness tolerances are shown \pm %10 .
- * Please indicate order code and coating type in your orders.

ART SERIES

TEL ÖRGÜ KANAL BAĞLANTILARI

WIRE MESH CABLE TRAY CONNECTIONS

90° Uygulama Örneği
Practice Example of 90°

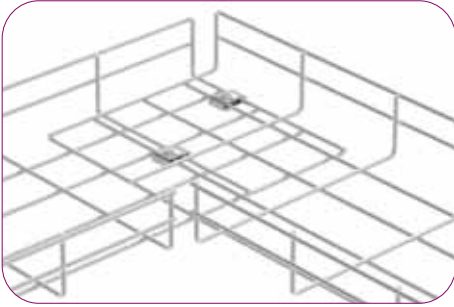
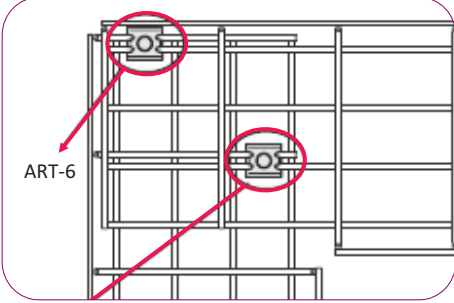
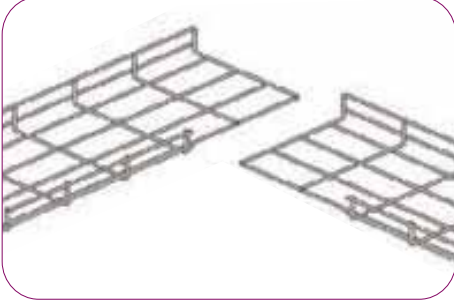
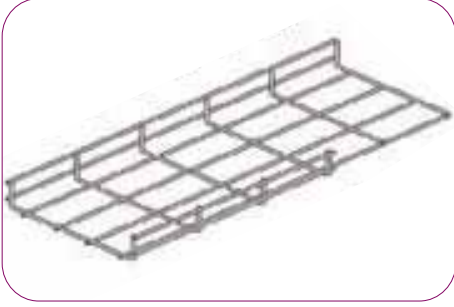

T Uygulama Örneği
Practice Example of T

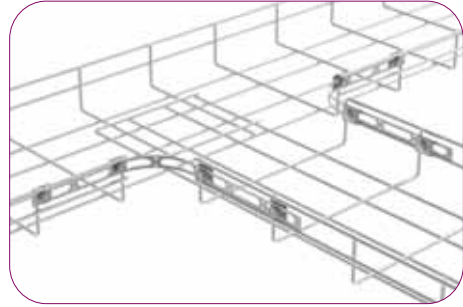
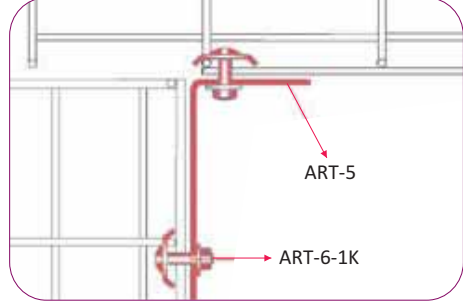
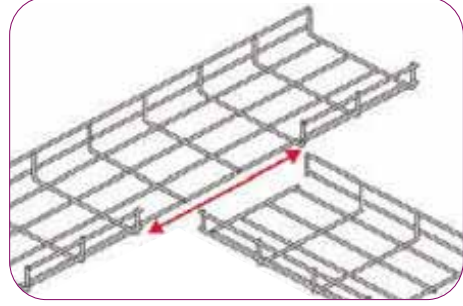
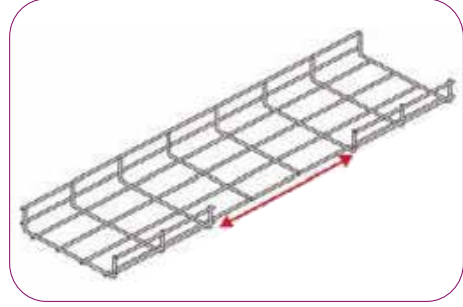

* Farklı kalınlık ve ölçülerde üretim yapılabılır.
* Malzeme ağırlıkları yaklaşık değerlerdir, \pm %10 değişiklik gösterebilir.
* Malzeme kalınlık toleransı \pm %10 dur.
* Lütfen siparişlerinizde sipariş kodu veya ürün kodu ve kaplama şeklini belirtiniz.

* We can produce cable trays different thickness and dimensions
* Cable trays are shown approximately weight, they could change \pm %10 difference.
* Cable trays thickness tolerances are shown \pm %10 .
* Please indicate order code and coating type in your orders.

ART SERIES

TEL ÖRGÜ KABLO KANAL KAPAKLARI

WIRE MESH CABLE TRAY COVERS

PREGALVANİZ (PG)
PREGALVANIZED (PG)
TS EN 10346



SICAK DALDIRMA (SD)
HOT DIP GALVANIZED (SD)
TS EN ISO 1461

PG

Sipariş Kodu Order Code	W (mm)	T (mm)	Ağırlık (kg/m) Weight (kg/m)	Barkod Kodu Barcode Code
ATKK 050-10	50	1.00 mm	0,707	2004150
ATKK 100-10	100	1.00 mm	1,047	2004151
ATKK 150-10	150	1.00 mm	1,147	2004152
ATKK 200-10	200	1.00 mm	1,847	2004153
ATKK 250-10	250	1.00 mm	2,233	2004154
ATKK 300-12	300	1.20 mm	3,147	2004155
ATKK 400-12	400	1.20 mm	4,085	2004156
ATKK 500-15	500	1.50 mm	6,261	2004157
ATKK 600-15	600	1.50 mm	7,483	2004158

ATKK 100 - 10



SD

Sipariş Kodu Order Code	W (mm)	T (mm)	Ağırlık (kg/m) Weight (kg/m)	Barkod Kodu Barcode Code
ATKK 050-10	50	1.00 mm	0,771	2004150
ATKK 100-10	100	1.00 mm	1,141	2004151
ATKK 150-10	150	1.00 mm	1,250	2004152
ATKK 200-10	200	1.00 mm	2,013	2004153
ATKK 250-10	250	1.00 mm	2,434	2004154
ATKK 300-12	300	1.20 mm	3,430	2004155
ATKK 400-12	400	1.20 mm	4,453	2004156
ATKK 500-15	500	1.50 mm	6,824	2004157
ATKK 600-15	600	1.50 mm	8,156	2004158

W = GENİŞLİK = WIDTH / T = KALINLIK = THICKNESS

Standart uzunluk L:3000 mm
Toplu miktarlarda Özel ölçüler yapılabilir.
Standard Length L:3000 mm
Custom sizes can be made in bulk quantities.

SEPERATÖR / SEPERATOR

PREGALVANİZ (PG)
PREGALVANIZED (PG)
TS EN 10346

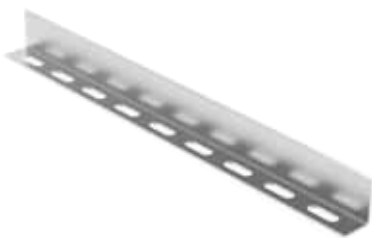

50

Sipariş Kodu Order Code	L (mm)	T (mm)	Ağırlık (kg/m) Weight (kg/m)	Barkod Kodu Barcode Code
50 ART SP-10	3.000	1.00 mm	0,628	2004170

85

Sipariş Kodu Order Code	L (mm)	T (mm)	Ağırlık (kg/m) Weight (kg/m)	Barkod Kodu Barcode Code
85 ART SP-10	3.000	1.00 mm	0,824	2004171

H100

Sipariş Kodu Order Code	L (mm)	T (mm)	Ağırlık (kg/m) Weight (kg/m)	Barkod Kodu Barcode Code
100 ART SP-1	3.000	1.00 mm	1,021	2004172

H = YÜKSEKLİK = HEIGHT / L = BOY = LENGTH / T = KALINLIK = THICKNESS

ARTIM METAL ELEKTRİK A.Ş.

* Farklı kalınlık ve ölçülerde üretim yapılabılır.
* Malzeme ağırlıkları yaklaşık değerlerdir, \pm %10 değişiklik gösterebilir.
* Malzeme kalınlık toleransı \pm %10 dur.
* Lütfen siparişlerinizde sipariş kodu veya ürün kodu ve Kaplama şeklini belirtiniz.

* We can produce cable trays different thickness and dimensions
* Cable trays are shown approximately weight, they could change \pm %10 difference.
* Cable trays thickness tolerances are shown \pm %10 .
* Please indicate order code and coating type in your orders.

art

POWER CARRYING SOLUTIONS



DÖŞEMEALTI KABLO KANALLARI

UNDERFLOOR CABLE TRAYS

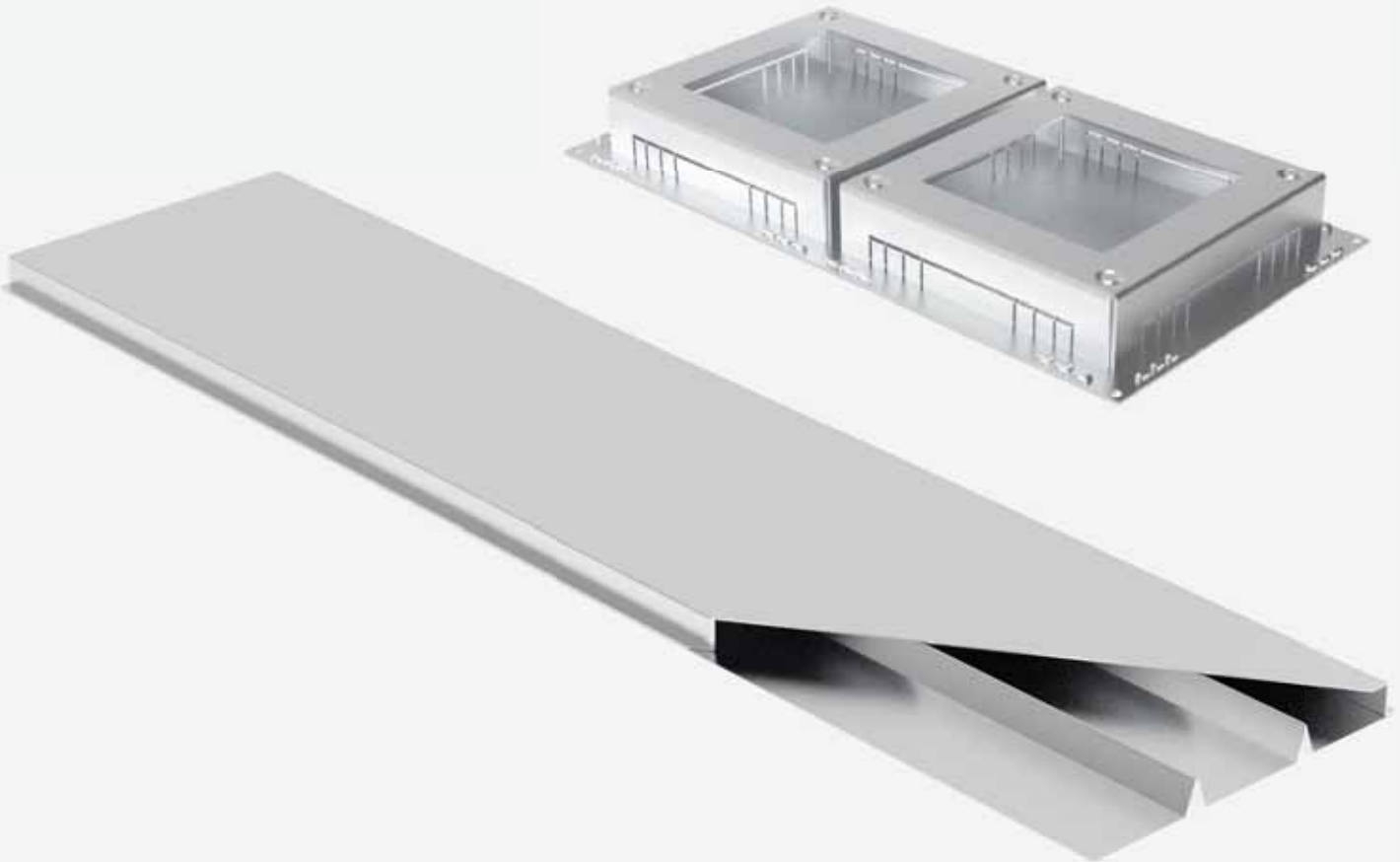

AD SERIES

DÖSEME ALTI KABLO KANALLARI

UNDERFLOOR TRUNKING

PREGALVANIZ (PG)
PREGALVANIZED (PG)
TS EN 10346



MODEL 1



MODEL 2

Sipariş Kodu Order Code	W (mm)	T (mm)	Ağırlık (kg/m) Weight (kg/m)	Barkod Kodu Barcode Code
30 AD 160-10	160	1.00 mm	3,641	2004200
30 AD 200-10	200	1.00 mm	4,310	2004201
30 AD 240-10	240	1.00 mm	4,920	2004202
30 AD 300-10	300	1.00 mm	5,865	2004203

Sipariş Kodu Order Code	W (mm)	T (mm)	Ağırlık (kg/m) Weight (kg/m)	Barkod Kodu Barcode Code
30 AD 160-12	160	1.20 mm	4,370	2004204
30 AD 200-12	200	1.20 mm	5,173	2004205
30 AD 240-12	240	1.20 mm	5,905	2004206
30 AD 300-12	300	1.20 mm	7,038	2004207

H = YÜKSEKLİK = HEIGHT / W = GENİŞLİK = WIDTH / T = KALINLIK = THICKNESS

Standart uzunluk L:3000 mm
Toplu miktarlarda Özel ölçüler yapılabilir.
Standard Length L:3000 mm
Custom sizes can be made in bulk quantities.

Model 2 Sıcak Daldırma Kaplama üretim yapılabilir.
Model 2 Hot Dip Galvanized Coating can also be made.

30 AD 200 -10

Yükseklik Kanal Tipi Genişlik Kalınlık
Height Type Width Thickness

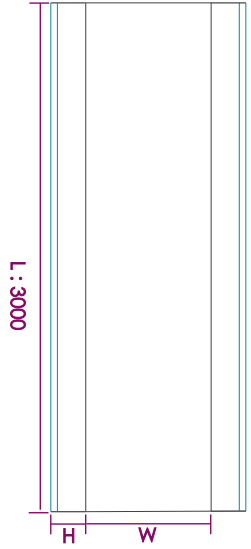

PREGALVANIZ (PG)
PREGALVANIZED (PG)
TS EN 10346



MODEL 1



MODEL 2

Sipariş Kodu Order Code	W (mm)	T (mm)	Ağırlık (kg/m) Weight (kg/m)	Barkod Kodu Barcode Code
40 AD 160-10	160	1.00 mm	3,641	2004208
40 AD 200-10	200	1.00 mm	4,310	2004209
40 AD 240-10	240	1.00 mm	4,920	2004210
40 AD 300-10	300	1.00 mm	5,865	2004211

Sipariş Kodu Order Code	W (mm)	T (mm)	Ağırlık (kg/m) Weight (kg/m)	Barkod Kodu Barcode Code
40 AD 160-12	160	1.20 mm	4,701	2004212
40 AD 200-12	200	1.20 mm	5,505	2004213
40 AD 240-12	240	1.20 mm	6,235	2004214
40 AD 300-12	300	1.20 mm	7,369	2004215

H = YÜKSEKLİK = HEIGHT / W = GENİŞLİK = WIDTH / T = KALINLIK = THICKNESS

Standart uzunluk L:3000 mm
Toplu miktarlarda Özel ölçüler yapılabilir.
Standard Length L:3000 mm
Custom sizes can be made in bulk quantities.

Model 2 Sıcak Daldırma Kaplama üretim yapılabilir.
Model 2 Hot Dip Galvanized Coating can also be made.

40 AD 200 -10

Yükseklik Kanal Tipi Genişlik Kalınlık
Height Type Width Thickness

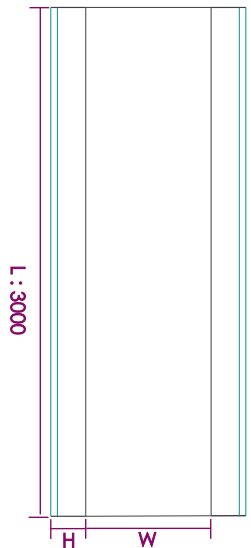

ARTIM METAL ELEKTRİK A.Ş.

* Farklı kalınlık ve ölçülerde üretim yapılabılır.
* Malzeme ağırlıkları yaklaşık değerlerdir, \pm %10 değişiklik gösterebilir.
* Malzeme kalınlık toleransı \pm %10 dur.
* Lütfen siparişlerinizde sipariş kodu veya ürün kodu ve Kaplama şeklini belirtiniz.

* We can produce cable trays different thickness and dimensions
* Cable trays are shown approximately weight, they could change \pm %10 difference.
* Cable trays thickness tolerances are shown \pm %10 .
* Please indicate order code and coating type in your orders.

AD SERIES

DÖSEME ALTI KABLO KANALLARI

UNDERFLOOR TRUNKING

PREGALVANIZ (PG)
PREGALVANIZED (PG)
TS EN 10346



BİRLEŞTİRME ELEMANI / STRAIGHT CONNECTORS

H30				
Sipariş Kodu Order Code	W (mm)	T (mm)	Ağırlık (kg/ad) Weight (kg/pcs)	Barkod Kodu Barcode Code
30 AD 160B	160	1.20 mm	0,230	2004221
30 AD 200B	200	1.20 mm	0,265	2004222
30 AD 240B	240	1.20 mm	0,300	2004223
30 AD 300B	300	1.20 mm	0,360	2004224

H40				
Sipariş Kodu Order Code	W (mm)	T (mm)	Ağırlık (kg/ad) Weight (kg/pcs)	Barkod Kodu Barcode Code
40 AD 160B	160	1.20 mm	0,240	2004225
40 AD 200B	200	1.20 mm	0,275	2004226
40 AD 240B	240	1.20 mm	0,315	2004227
40 AD 300B	300	1.20 mm	0,370	2004228

H = YÜKSEKLİK = HEIGHT / W = GENİŞLİK = WIDTH / T = KALINLIK = THICKNESS

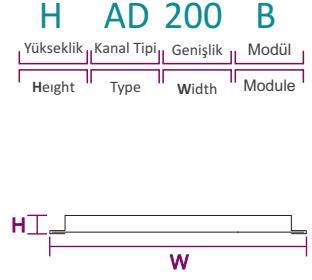

PREGALVANIZ (PG)
PREGALVANIZED (PG)
TS EN 10346



90° YUKARI DÖNÜŞ ELEMANI / 90° BENDING UNIT

UNDERFLOOR TRAY

H30				
Sipariş Kodu Order Code	W (mm)	T (mm)	Ağırlık (kg/ad) Weight (kg/pcs)	Barkod Kodu Barcode Code
30 AD 160Y	160	1.20 mm	1,355	2004231
30 AD 200Y	200	1.20 mm	1,770	2004232
30 AD 240Y	240	1.20 mm	1,980	2004233
30 AD 300Y	300	1.20 mm	2,290	2004234

H40				
Sipariş Kodu Order Code	W (mm)	T (mm)	Ağırlık (kg/ad) Weight (kg/pcs)	Barkod Kodu Barcode Code
40 AD 160Y	160	1.20 mm	1,420	2004235
40 AD 200Y	200	1.20 mm	1,810	2004236
40 AD 240Y	240	1.20 mm	2,035	2004237
40 AD 300Y	300	1.20 mm	2,370	2004238

H = YÜKSEKLİK = HEIGHT / W = GENİŞLİK = WIDTH / T = KALINLIK = THICKNESS

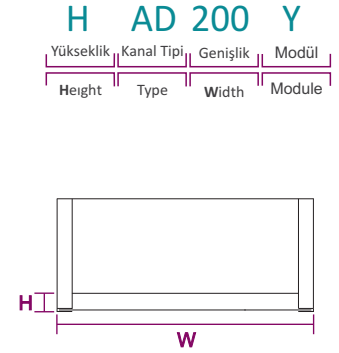

* Farklı kalınlık ve ölçülerde üretim yapılabılır.
* Malzeme ağırlıkları yaklaşık değerlerdir, ± %10 değişiklik gösterebilir.
* Malzeme kalınlık toleransı ± %10 dur.
* Lütfen siparişlerinizde sipariş kodu veya ürün kodu ve Kaplama şeklini belirtiniz.

* We can produce cable trays different thickness and dimensions
* Cable trays are shown approximately weight, they could change ± %10 difference.
* Cable trays thickness tolerances are shown ± %10 .
* Please indicate order code and coating type in your orders.

AD SERIES

DÖSEME ALTI KABLO KANALLARI

UNDERFLOOR TRUNKING

PREGALVANİZ (PG)
PREGALVANIZED (PG)
TS EN 10346



SONLANDIRMA ELEMANI / END CAPS

Sipariş Kodu Order Code	W (mm)	T (mm)	Ağırlık (kg/ad) Weight (kg/pcs)	Barkod Kodu Barcode Code
30 AD 160S	160	1.20 mm	0,286	2004241
30 AD 200S	200	1.20 mm	0,335	2004242
30 AD 240S	240	1.20 mm	0,384	2004243
30 AD 300S	300	1.20 mm	0,431	2004244

Sipariş Kodu Order Code	W (mm)	T (mm)	Ağırlık (kg/ad) Weight (kg/pcs)	Barkod Kodu Barcode Code
40 AD 160S	160	1.20 mm	0,313	2004245
40 AD 200S	200	1.20 mm	0,364	2004246
40 AD 240S	240	1.20 mm	0,418	2004247
40 AD 300S	300	1.20 mm	0,441	2004248

H = YÜKSEKLİK = HEIGHT / W = GENİŞLİK = WIDTH / T = KALINLIK = THICKNESS

H AD 200 S

Yükseklik Kanal Tipi Genişlik Modül
Height Type Width Module



PREGALVANİZ (PG)
PREGALVANIZED (PG)
TS EN 10346



MODEL 1



MODEL 2

KANAL SEVİYE DEĞİŞTİRME / LEVEL ADJUSTMENT UNIT

Sipariş Kodu Order Code	W (mm)	T (mm)	Ağırlık (kg/ad) Weight (kg/pcs)	Barkod Kodu Barcode Code
AD 160 SD	160	2.00 mm	0,188	2004251
AD 200 SD	200	2.00 mm	0,220	2004252
AD 240 SD	240	2.00 mm	0,251	2004253
AD 300 SD	300	2.00 mm	0,298	2004254

AD 200 SD

Kanal Tipi Genişlik Modül
Type Width Module



ARTIM METAL ELEKTRİK A.Ş.

* Farklı kalınlık ve ölçülerde üretim yapılabılır.
* Malzeme ağırlıkları yaklaşık değerlerdir, ± %10 değişiklik gösterebilir.
* Malzeme kalınlık toleransı ± %10 dur.
* Lütfen siparişlerinizde sipariş kodu veya ürün kodu ve Kaplama şeklini belirtiniz.

* We can produce cable trays different thickness and dimensions
* Cable trays are shown approximately weight, they could change ± %10 difference.
* Cable trays thickness tolerances are shown ± %10 .
* Please indicate order code and coating type in your orders.

AD SERIES

DÖŞEME ALTI KABLO KANALLARI

UNDERFLOOR TRUNKING

PREGALVANIZ (PG)
PREGALVANIZED (PG)
TS EN 10346

DÖŞEME ALTI BOŞ BUAT KUTUSU (TEKLİ)/ UNDERFLOOR EMPTY BOX (SINGLE)

Sipariş Kodu Order Code	Ebat (mm) Size (mm)	Ağırlık (kg/ad) Weight (kg/pcs)	Barkod Kodu Barcode Code
ART-M	352x352	2,530	2004301



ART-M

DÖŞEME ALTI BOŞ BUAT KUTUSU (ÇİFTLİ)/ UNDERFLOOR EMPTY BOX (DOUBLE)

Sipariş Kodu Order Code	Ebat (mm) Size (mm)	Ağırlık (kg/ad) Weight (kg/pcs)	Barkod Kodu Barcode Code
ART-MC	352x704	5,060	2004302



ART-MC

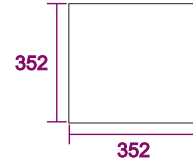
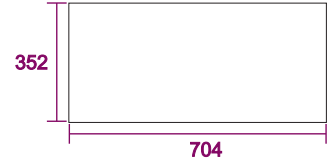

PLASTİK
PLASTIC

BUAT İÇİ PRİZ KASASI (6LI-8Lİ) / SOCKET CASE (6-8 MODULE)

Sipariş Kodu Order Code	Ebat (mm) Size (mm)	Ağırlık (kg/ad) Weight (kg/pcs)	Barkod Kodu Barcode Code
ART-P (8)	260x260	1,350	2004311
ART-P (6)	260x260	1,400	2004312

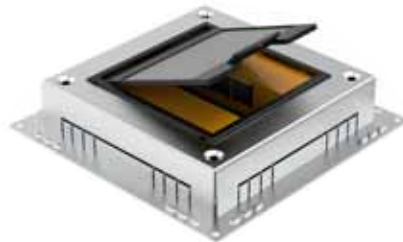
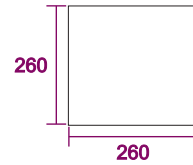

Priz kasaları 6 adet ve 8 adet priz çıkışlıdır.
Priz yuva ölçüleri 45X45 mm dir.
Telfon, data ölçüleri 22,5X45 mm dir.
Socket cases have 6 and 8 socket outlets.
Socket dimensions are 45x45 mm.
Phone and data dimensions are 22.5x45 mm.

* Farklı kalınlık ve ölçülerde üretim yapılabılır.
* Malzeme ağırlıkları yaklaşık değerlerdir, \pm %10 değişiklik gösterebilir.
* Malzeme kalınlık toleransı \pm %10 dur.
* Lütfen siparişlerinizde sipariş kodu veya ürün kodu ve Kaplama şeklini belirtiniz.

* We can produce cable trays different thickness and dimensions
* Cable trays are shown approximately weight, they could change \pm %10 difference.
* Cable trays thickness tolerances are shown \pm %10 .
* Please indicate order code and coating type in your orders.

AD SERIES

DÖŞEME ALTI KABLO KANALLARI

UNDERFLOOR TRUNKING

PLASTİK
PLASTIC



ART-MK (1)



RAL 7035

RAL 9016

RAL 9005

METALİK / METALLIC

PLASTİK PRİZ ÇIKIŞ KUTUSU (2Lİ) / PLASTIC SOCKET
OUTLET BOX (2 MODULE)

Sipariş Kodu Order Code	Ebat (mm) Size (mm)	Ağırlık (kg/ad) Weight (kg/pcs)	Barkod Kodu Barcode Code
ART-MK (1)	45x45	-	2004313

PLASTİK PRİZ ÇIKIŞ KUTUSU (2Lİ) / PLASTIC SOCKET
OUTLET BOX (2 MODULE)

Sipariş Kodu Order Code	Ebat (mm) Size (mm)	Ağırlık (kg/ad) Weight (kg/pcs)	Barkod Kodu Barcode Code
ART-MK (2)	45x45	-	2004314



ART-MK (2)



RAL 7035

RAL 9016

RAL 9005

METALİK / METALLIC

Standart renk kodu RAL 7035
Farklı renk talebinizde Ral Kodu belirtiniz.
Standard color code RAL 7035
Specify the Ral Code in your different color request.

PREGALVANİZ (PG)
PREGALVANIZED (PG)
TS EN 10346



ART-K (1)



ART-K (2)

DÖŞEME ALTI BUAT KAPAĞI / JUNCTION BOX COVER

Sipariş Kodu Order Code	Ebat (mm) Size (mm)	Ağırlık (kg/ad) Weight (kg/pcs)	Barkod Kodu Barcode Code
ART-K (1)	260x260	0,795	2004303
ART-K (2)	360x360	1,290	2004304

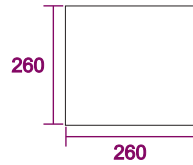

ARTIM METAL ELEKTRİK A.Ş.

* Farklı kalınlık ve ölçülerde üretim yapılabılır.
* Malzeme ağırlıkları yaklaşık değerlerdir, \pm %10 değişiklik gösterebilir.
* Malzeme kalınlık toleransı \pm %10 dur.
* Lütfen siparişlerinizde sipariş kodu veya ürün kodu ve Kaplama şeklini belirtiniz.

* We can produce cable trays different thickness and dimensions
* Cable trays are shown approximately weight, they could change \pm %10 difference.
* Cable trays thickness tolerances are shown \pm %10 .
* Please indicate order code and coating type in your orders.

AD SERIES

DÖSEME ALTI KABLO KANALLARI

UNDERFLOOR TRUNKING

PLASTIK
PLASTIC



TOPRAKLI PRİZ / GROUNDED SOCKET

Sipariş Kodu	Ebat (mm)	Ağırlık (kg/ad)	Barkod Kodu
Order Code	Size (mm)	Weight (kg/pcs)	Barcode Code
ART-PRİZ T	45x45	-	2004321



UPS PRİZ / UPS SOCKET

Sipariş Kodu	Ebat (mm)	Ağırlık (kg/ad)	Barkod Kodu
Order Code	Size (mm)	Weight (kg/pcs)	Barcode Code
ART-PRİZ U	45x45	-	2004322



CAT5 DATA SOKET / CAT5 DATA SOCKET

Sipariş Kodu	Ebat (mm)	Ağırlık (kg/ad)	Barkod Kodu
Order Code	Size (mm)	Weight (kg/pcs)	Barcode Code
ART-DATA S	22,5x45	-	2004323

DATA PRİZ KAPAĞI / DATA SOCKET COVER

Sipariş Kodu	Ebat (mm)	Ağırlık (kg/ad)	Barkod Kodu
Order Code	Size (mm)	Weight (kg/pcs)	Barcode Code
ART-DATA K	22,5x45	-	2004324

* Farklı kalınlık ve ölçülerde üretim yapılabılır.
* Malzeme ağırlıkları yaklaşık değerlerdir, \pm %10 değişiklik gösterebilir.
* Malzeme kalınlık toleransı \pm %10 dur.
* Lütfen siparişlerinizde sipariş kodu veya ürün kodu ve kaplama şeklini belirtiniz.

* We can produce cable trays different thickness and dimensions
* Cable trays are shown approximately weight, they could change \pm %10 difference.
* Cable trays thickness tolerances are shown \pm %10 .
* Please indicate order code and coating type in your orders.

art

 WWW.ARTIMMETAL.COM

POWER CARRYING SOLUTIONS

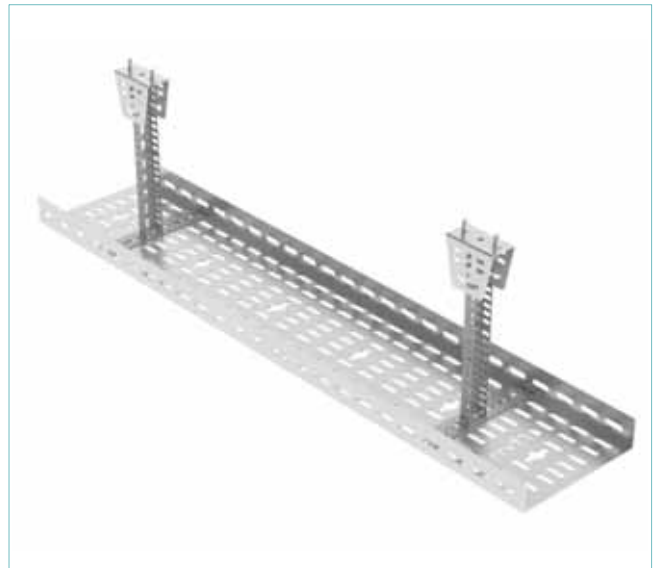
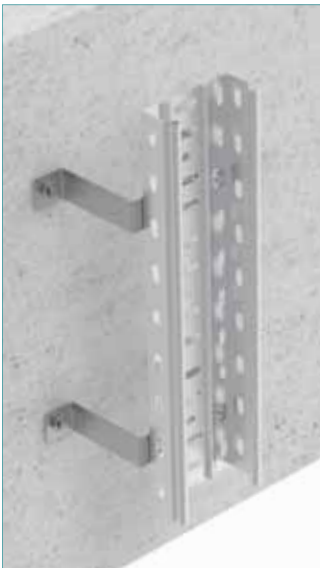
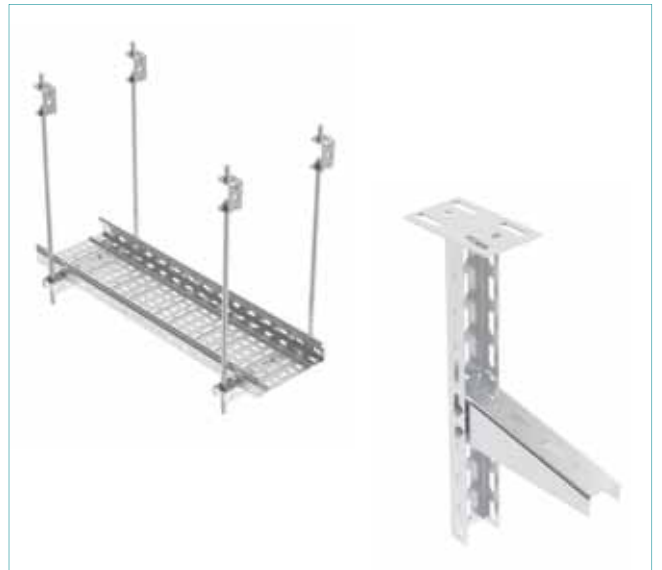

art

POWER CARRYING SOLUTIONS



TAŞIYICI & DESTEK SİSTEMLERİ

CARRIER & SUPPORT SYSTEMS

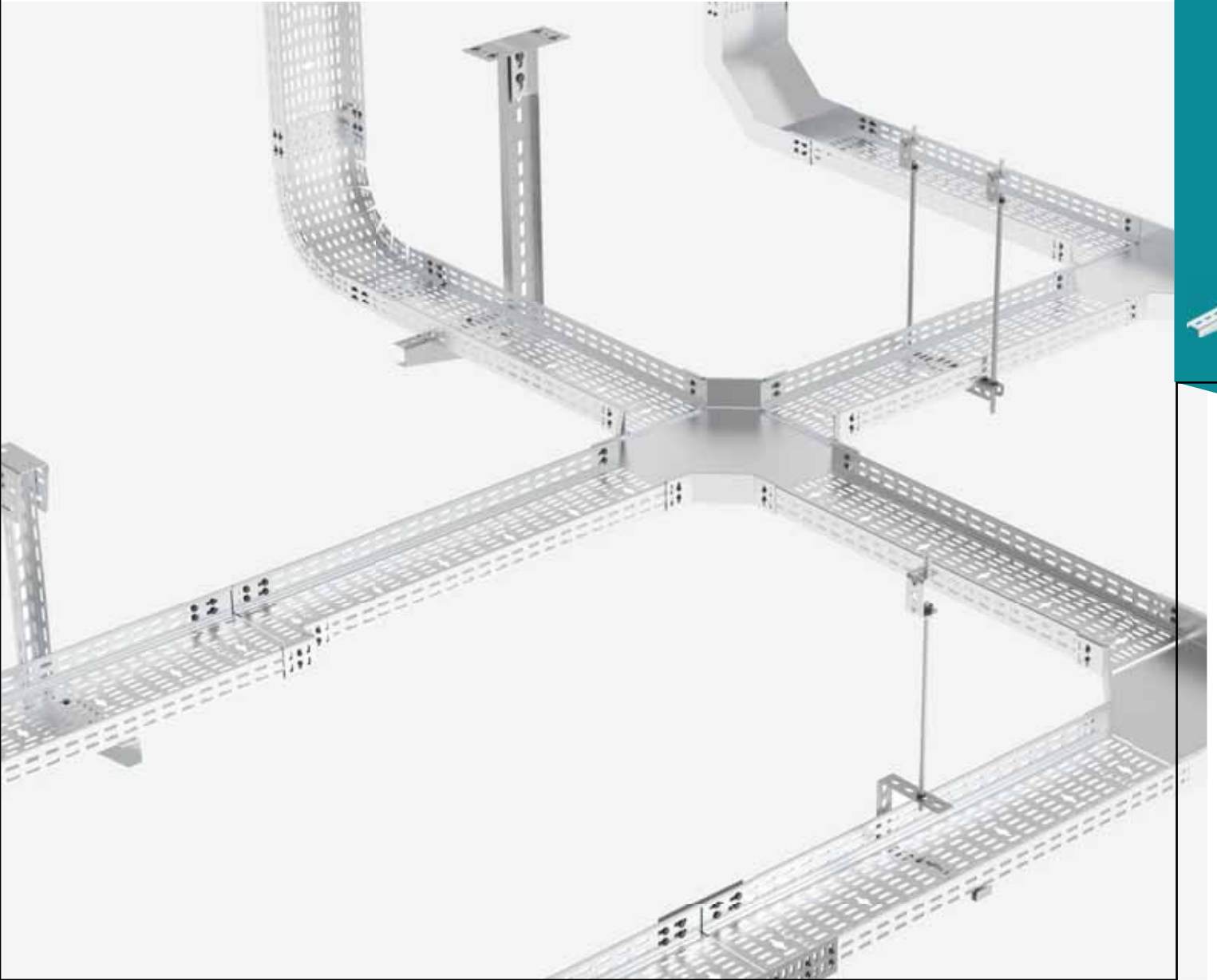

DS SERIES

DESTEK SİSTEMİ

SUPPORT SYSTEM

PREGALVANİZ (PG)
PREGALVANIZED (PG)
TS EN 10346

SICAK DALDIRMA (SD)
HOT DIP GALVANIZED (HDG)
TS EN ISO 1461

U PROFİL / U PROFILE

PG

Sipariş Kodu Order Code	L (mm)	T (mm)	Ağırlık (kg/m) Weight (kg/m)	Barkod Kodu Barcode Code
UP 30x50x30 -15	2.500	1.50 mm	1,102	2003000
UP 30x50x30 -20	2.500	2.00 mm	1,470	2003001
UP 30x30x30 -15	2.500	1.50 mm	0,890	2003002
UP 30x30x30 -20	2.500	2.00 mm	1,187	2003003
UP 20x40x20 -15	2.500	1.50 mm	0,784	2003004
UP 20x40x20 -20	2.500	2.00 mm	1,046	2003005
UP 40x40x40 -15	2.500	1.50 mm	1,208	2003006
UP 40x40x40 -20	2.500	2.00 mm	1,610	2003006

SD / HDG

Sipariş Kodu Order Code	L (mm)	T (mm)	Ağırlık (kg/m) Weight (kg/m)	Barkod Kodu Barcode Code
UP 30x50x30 -15	2.500	1.50 mm	1,190	2003000
UP 30x50x30 -20	2.500	2.00 mm	1,590	2003001
UP 30x30x30 -15	2.500	1.50 mm	0,961	2003002
UP 30x30x30 -20	2.500	2.00 mm	1,282	2003003
UP 20x40x20 -15	2.500	1.50 mm	0,847	2003004
UP 20x40x20 -20	2.500	2.00 mm	1,129	2003005
UP 40x40x40 -15	2.500	1.50 mm	1,305	2003006
UP 40x40x40 -20	2.500	2.00 mm	1,740	2003006

L = BOY = LENGTH / T = KALINLIK = THICKNESS

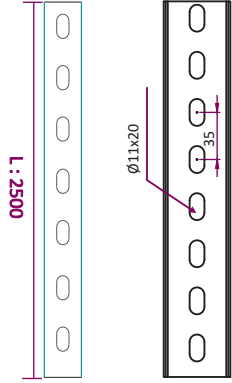

Standart uzunluk L:2500 mm
Toplu miktarlarda Özel ölçüler yapılabilir.
Standard Length L:2500 mm
Custom sizes can be made in bulk quantities.



UP 30x50x30

UP 30x30x30

UP 20x40x20

UP 40x40x40



ARTIM METAL ELEKTRİK A.Ş.

- * Farklı kalınlık ve ölçülerde üretim yapılabılır.
- * Malzeme ağırlıkları yaklaşık değerlerdir, \pm %10 değişiklik gösterebilir.
- * Malzeme kalınlık toleransı \pm %10 dur.
- * Lütfen siparişlerinizde sipariş kodu veya ürün kodu ve Kaplama şeklini belirtiniz.

- * We can produce cable trays different thickness and dimensions
- * Cable trays are shown approximately weight, they could change \pm %10 difference.
- * Cable trays thickness tolerances are shown \pm %10 .
- * Please indicate order code and coating type in your orders.

DS SERIES

DESTEK SİSTEMİ

SUPPORT SYSTEM

PREGALVANİZ (PG)
PREGALVANIZED (PG)
TS EN 10346

SICAK DALDIRMA (SD)
HOT DIP GALVANIZED (HDG)
TS EN ISO 1461

U TAVAN TESPİT / U HANGING SUPPORT CEILING



Paket Miktarı = 100 AD
Package Content = 100 PCS

PG				
Sipariş Kodu Order Code	L (mm)	T (mm)	Ağırlık (kg/ad) Weight (kg/pcs)	Barkod Kodu Barcode Code
UPG	100	2.00 mm	0,355	2003056

SD / HDG				
Sipariş Kodu Order Code	L (mm)	T (mm)	Ağırlık (kg/ad) Weight (kg/pcs)	Barkod Kodu Barcode Code
UPG	100	2.00 mm	0,390	2003056

L = BOY = LENGTH / T = KALINLIK = THICKNESS

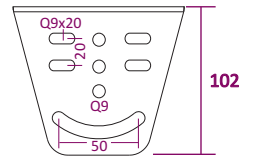
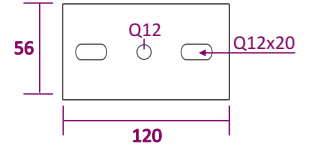

U TAVAN TESPİT / U HANGING SUPPORT CEILING



Paket Miktarı = 100 AD
Package Content = 100 PCS

PG				
Sipariş Kodu Order Code	L (mm)	T (mm)	Ağırlık (kg/ad) Weight (kg/pcs)	Barkod Kodu Barcode Code
UPG-1	75	2.00 mm	0,260	2003057

SD / HDG				
Sipariş Kodu Order Code	L (mm)	T (mm)	Ağırlık (kg/ad) Weight (kg/pcs)	Barkod Kodu Barcode Code
UPG-1	75	2.00 mm	0,281	2003057

L = BOY = LENGTH / T = KALINLIK = THICKNESS

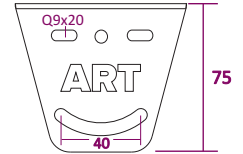
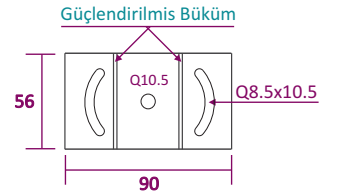

* Farklı kalınlık ve ölçülerde üretim yapıla bilinir.
* Malzeme ağırlıkları yaklaşık değerlerdir, ± %10 değişiklik gösterebilir.
* Malzeme kalınlık toleransı ± %10 dur.
* Lütfen siparişlerinizde sipariş kodu veya ürün kodu ve Kaplama şeklini belirtiniz.

* We can produce cable trays different thickness and dimensions
* Cable trays are shown approximately weight, they could change ± %10 difference.
* Cable trays thickness tolerances are shown ± %10 .
* Please indicate order code and coating type in your orders.

DS SERIES

DESTEK SİSTEMİ

SUPPORT SYSTEM

PREGALVANİZ (PG)
PREGALVANIZED (PG)
TS EN 10346

SICAK DALDIRMA (SD)
HOT DIP GALVANIZED (HDG)
TS EN ISO 1461

DİKEY U BAĞLANTI ELEMANI / VERTICAL U CONNECTION ELEMENT



Sipariş Kodu Order Code	L (mm)	T (mm)	Ağırlık (kg/ad) Weight (kg/pcs)	Barkod Kodu Barcode Code
UB-1	120	2.00 mm	0,160	2003052

Sipariş Kodu Order Code	L (mm)	T (mm)	Ağırlık (kg/ad) Weight (kg/pcs)	Barkod Kodu Barcode Code
UB-1	120	2.00 mm	0,176	2003052

PG

SD / HDG

L = BOY = LENGTH / T = KALINLIK = THICKNESS

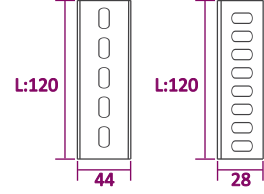

Paket Miktarı = 100 AD
Package Content = 100 PCS

SIRT SIRTA U BAĞLANTI ELEMANI / SHOULDER TO SHOULDER U CONNECTION ELEMENT



Sipariş Kodu Order Code	L (mm)	T (mm)	Ağırlık (kg/ad) Weight (kg/pcs)	Barkod Kodu Barcode Code
UB-2	60	2.00 mm	0,022	2003053

Sipariş Kodu Order Code	L (mm)	T (mm)	Ağırlık (kg/ad) Weight (kg/pcs)	Barkod Kodu Barcode Code
UB-2	60	2.00 mm	0,026	2003053

PG

SD / HDG

L = BOY = LENGTH / T = KALINLIK = THICKNESS

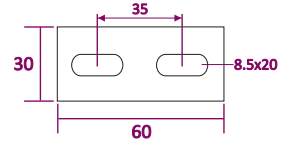

UB-1



UB-2

ARTIM METAL ELEKTRİK A.Ş.

- * Farklı kalınlık ve ölçülerde üretim yapılabılır.
- * Malzeme ağırlıkları yaklaşık değerlerdir, \pm %10 değişiklik gösterebilir.
- * Malzeme kalınlık toleransı \pm %10 dur.
- * Lütfen siparişlerinizde sipariş kodu veya ürün kodu ve Kaplama şeklini belirtiniz.

- * We can produce cable trays different thickness and dimensions
- * Cable trays are shown approximately weight, they could change \pm %10 difference.
- * Cable trays thickness tolerances are shown \pm %10 .
- * Please indicate order code and coating type in your orders.

DS SERIES DESTEK SİSTEMİ SUPPORT SYSTEM

PREGALVANİZ (PG)
PREGALVANIZED (PG)
TS EN 10346

SICAK DALDIRMA (SD)
HOT DIP GALVANIZED (HDG)
TS EN ISO 1461

U TAVAN TESPİT / U HANGING SUPPORT CEILING



Sipariş Kodu Order Code	L (mm)	T (mm)	Ağırlık (kg/ad) Weight (kg/pcs)	Barkod Kodu Barcode Code
UPT-12	120	2.00 mm	0,404	2003054

PG

T = Kalınlık = Thickness = 3.00 mm

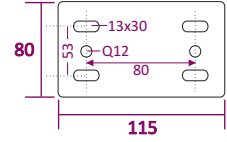

SD / HDG

T = Kalınlık = Thickness = 2.00 mm

Sipariş Kodu Order Code	L (mm)	T (mm)	Ağırlık (kg/ad) Weight (kg/pcs)	Barkod Kodu Barcode Code
UPT-12	120	2.00 mm	0,435	2003054

L = BOY = LENGTH / T = KALINLIK = THICKNESS

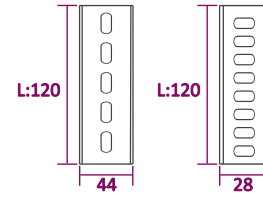

U TAVAN TESPİT / U HANGING SUPPORT CEILING



Sipariş Kodu Order Code	L (mm)	T (mm)	Ağırlık (kg/ad) Weight (kg/pcs)	Barkod Kodu Barcode Code
UPT-12D	110	2.00 mm	0,591	2003055

PG

T = Kalınlık = Thickness = 3.00 mm

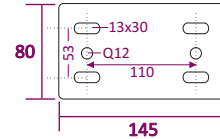

SD / HDG

T = Kalınlık = Thickness = 2.00 mm

Sipariş Kodu Order Code	L (mm)	T (mm)	Ağırlık (kg/ad) Weight (kg/pcs)	Barkod Kodu Barcode Code
UPT-12D	110	2.00 mm	0,635	2003055

L = BOY = LENGTH / T = KALINLIK = THICKNESS

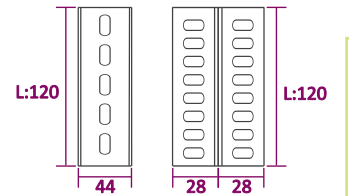

* Farklı kalınlık ve ölçülerde üretim yapıla bilinir.
* Malzeme ağırlıkları yaklaşık değerlerdir, ± %10 değişiklik gösterebilir.
* Malzeme kalınlık toleransı ± %10 dur.
* Lütfen siparişlerinizde sipariş kodu veya ürün kodu ve Kaplama şeklini belirtiniz.

* We can produce cable trays different thickness and dimensions
* Cable trays are shown approximately weight, they could change ± %10 difference.
* Cable trays thickness tolerances are shown ± %10 .
* Please indicate order code and coating type in your orders.

DS SERIES

DESTEK SİSTEMİ

SUPPORT SYSTEM

PREGALVANİZ (PG)
PREGALVANIZED (PG)
TS EN 10346

SICAK DALDIRMA (SD)
HOT DIP GALVANIZED (HDG)
TS EN ISO 1461

U TAVAN TESPİT / U HANGING SUPPORT CEILING



PG				
Sipariş Kodu Order Code	L (mm)	T (mm)	Ağırlık (kg/ad) Weight (kg/pcs)	Barkod Kodu Barcode Code
UPT 50	500	1.50 mm	0,782	2003058
UPT 100	1.000	1.50 mm	1,306	2003059
UPT 50	500	2.00 mm	0,930	2003050
UPT 100	1.000	2.00 mm	1,701	2003051

SD / HDG				
Sipariş Kodu Order Code	L (mm)	T (mm)	Ağırlık (kg/ad) Weight (kg/pcs)	Barkod Kodu Barcode Code
UPT 50	500	1.50 mm	0,860	2003058
UPT 100	1.000	1.50 mm	1,436	2003059
UPT 50	500	2.00 mm	1,000	2003050
UPT 100	1.000	2.00 mm	1,830	2003051

L = BOY = LENGTH / T = KALINLIK = THICKNESS

T = Kalınlık = Thickness = 3.00 mm

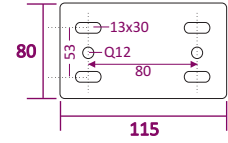

T = Kalınlık = Thickness = 1.50/2.00 mm

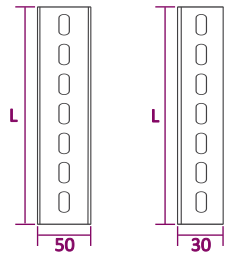

U DESTEK KONSOLLARI / U SUPPORT BRACKETS



PG				
Sipariş Kodu Order Code	L (mm)	T (mm)	Ağırlık (kg/ad) Weight (kg/pcs)	Barkod Kodu Barcode Code
US 100	130	1.50 mm	0,175	2003100
US 160	190	1.50 mm	0,322	2003101
US 200	230	1.50 mm	0,322	2003102
US 300	330	1.50 mm	0,460	2003103
US 400	430	2.00 mm	0,746	2003104
US 500	530	2.00 mm	0,921	2003105
US 600	630	2.00 mm	1,355	2003106

SD / HDG				
Sipariş Kodu Order Code	L (mm)	T (mm)	Ağırlık (kg/ad) Weight (kg/pcs)	Barkod Kodu Barcode Code
US 100	130	1.50 mm	0,191	2003100
US 160	190	1.50 mm	0,293	2003101
US 200	230	1.50 mm	0,355	2003102
US 300	330	1.50 mm	0,460	2003103
US 400	430	2.00 mm	0,746	2003104
US 500	530	2.00 mm	0,921	2003105
US 600	630	2.00 mm	1,355	2003106

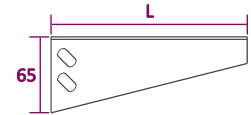

Paket Miktarı (ad)

Package Content (pcs)

US 100	120
US 160	72
US 200	72
US 300	50
US 400	40
US 500	-
US 600	-

ARTIM METAL ELEKTRİK A.Ş.

* Farklı kalınlık ve ölçülerde üretim yapılabılır.
* Malzeme ağırlıkları yaklaşık değerlerdir, \pm %10 değişiklik gösterebilir.
* Malzeme kalınlık toleransı \pm %10 dur.
* Lütfen siparişlerinizde sipariş kodu veya ürün kodu ve Kaplama şeklini belirtiniz.

* We can produce cable trays different thickness and dimensions
* Cable trays are shown approximately weight, they could change \pm %10 difference.
* Cable trays thickness tolerances are shown \pm %10 .
* Please indicate order code and coating type in your orders.

DS SERIES

DESTEK SİSTEMİ

SUPPORT SYSTEM

PREGALVANİZ (PG)
PREGALVANIZED (PG)
TS EN 10346

SICAK DALDIRMA (SD)
HOT DIP GALVANIZED (HDG)
TS EN ISO 1461

AĞIR HİZMET TİPİ KANAL TAŞIYICILAR / HEAVY DUTY CABLE TRAY CARRIERS



Sipariş Kodu Order Code	L (mm)	T (mm)	Ağırlık (kg/ad) Weight (kg/pcs)	SD / HDG	
				Barkod Kodu Barcode Code	
UDAT 300	345	2.00 mm	1,534	2003081	
UDAT 400	445	2.00 mm	1,714	2003082	
UDAT 500	545	2.00 mm	1,893	2003083	
UDAT 600	645	2.00 mm	2,073	2003084	
UDAT 700	745	2.00 mm	2,252	2003085	
UDAT 800	845	2.00 mm	2,432	2003086	
UDAT 900	945	2.00 mm	2,611	2003087	
UDAT 1000	1.045	2.00 mm	2,792	2003088	

L = BOY = LENGTH / T = KALINLIK = THICKNESS

T = Kalınlık = Thickness = 3.00 mm

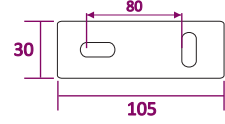

T = Kalınlık = Thickness = 2.00 mm

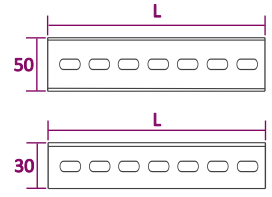

L PROFİL / L PROFILE



Sipariş Kodu Order Code	L (mm)	T (mm)	Ağırlık (kg/m) Weight (kg/m)	PG	
				Barkod Kodu Barcode Code	
LK 100-15	2.500	1.50 mm	0,810	2003250	
LK 100-20	2.500	2.00 mm	1,080	2003251	

Sipariş Kodu Order Code	L (mm)	T (mm)	Ağırlık (kg/m) Weight (kg/m)	SD / HDG	
				Barkod Kodu Barcode Code	
LK 100-15	2.500	1.50 mm	0,890	2003250	
LK 100-20	2.500	2.00 mm	1,190	2003251	

L = BOY = LENGTH / T = KALINLIK = THICKNESS

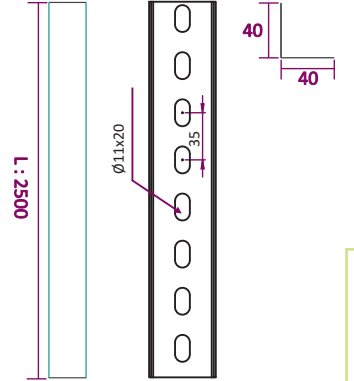

* Farklı kalınlık ve ölçülerde üretim yapılabılır.
* Malzeme ağırlıkları yaklaşık değerlerdir, \pm %10 değişiklik gösterebilir.
* Malzeme kalınlık toleransı \pm %10 dur.
* Lütfen siparişlerinizde sipariş kodu veya ürün kodu ve kaplama şeklini belirtiniz.

* We can produce cable trays different thickness and dimensions
* Cable trays are shown approximately weight, they could change \pm %10 difference.
* Cable trays thickness tolerances are shown \pm %10 .
* Please indicate order code and coating type in your orders.

DS SERIES

DESTEK SİSTEMİ

SUPPORT SYSTEM

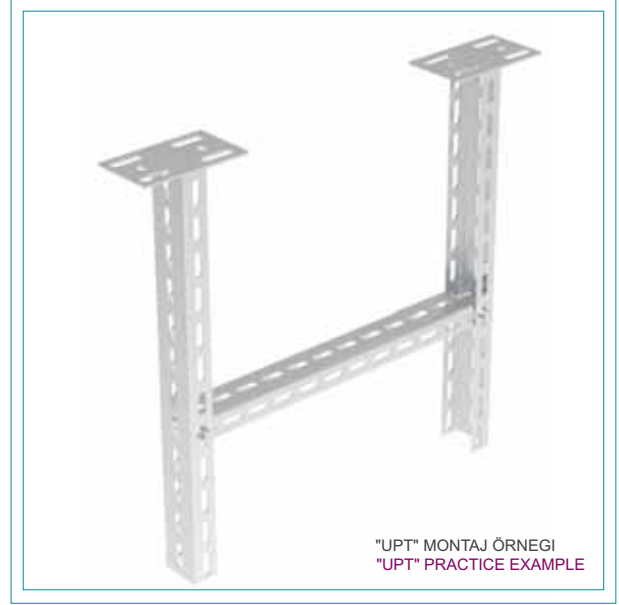
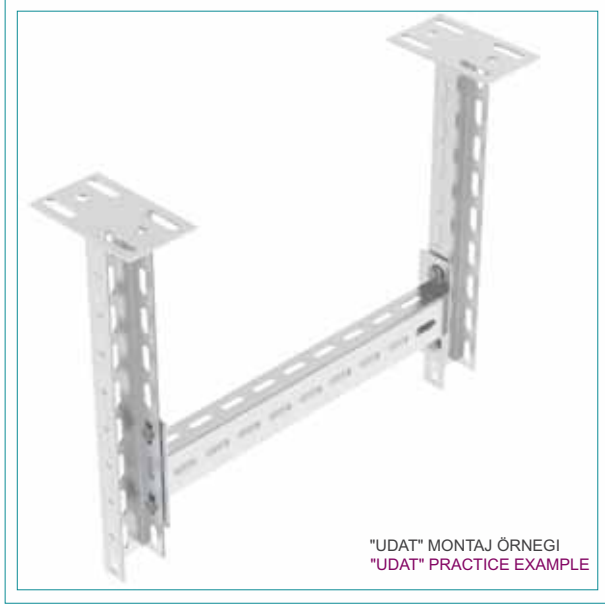

ARTIM METAL ELEKTRİK A.Ş.

- * Farklı kalınlık ve ölçülerde üretim yapılabılır.
- * Malzeme ağırlıkları yaklaşık değerlerdir, \pm %10 değişiklik gösterebilir.
- * Malzeme kalınlık toleransı \pm %10 dur.
- * Lütfen siparişlerinizde sipariş kodu veya ürün kodu ve Kaplama şeklini belirtiniz.

- We can produce cable trays different thickness and dimensions
- Cable trays are shown approximately weight, they could change \pm %10 difference.
- Cable trays thickness tolerances are shown \pm %10 .
- Please indicate order code and coating type in your orders.

DS SERIES

DESTEK SİSTEMİ

SUPPORT SYSTEM

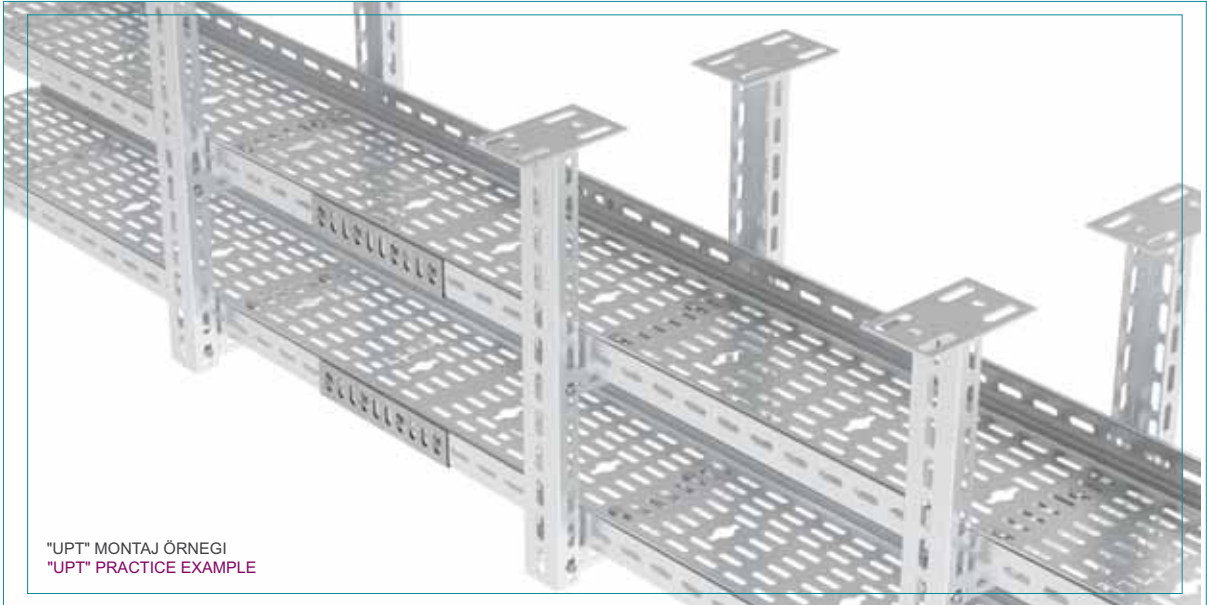

- * Farklı kalınlık ve ölçülerde üretim yapılabılır.
- * Malzeme ağırlıkları yaklaşık değerlerdir, \pm %10 değişiklik gösterebilir.
- * Malzeme kalınlık toleransı \pm %10 dur.
- * Lütfen siparişlerinizde sipariş kodu veya ürün kodu ve Kaplama şeklini belirtiniz.

- * We can produce cable trays different thickness and dimensions
- * Cable trays are shown approximately weight, they could change \pm %10 difference.
- * Cable trays thickness tolerances are shown \pm %10 .
- * Please indicate order code and coating type in your orders.

DS SERIES

DESTEK SİSTEMİ

SUPPORT SYSTEM

PREGALVANİZ (PG)
PREGALVANIZED (PG)
TS EN 10346

SICAK DALDIRMA (SD)
HOT DIP GALVANIZED (HDG)
TS EN ISO 1461



L TAVAN TESPİT / L HANGING SUPPORT CEILING

Sipariş Kodu Order Code	L (mm)	T1/T2 (mm)	Ağırlık (kg/ad) Weight (kg/pcs)	Barkod Kodu Barcode Code
LT-12	120	3/1,5 mm	0,235	2003390

PG

T = Kalınlık = Thickness = 3.00 mm

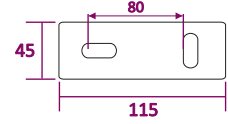

SD / HDG

Sipariş Kodu Order Code	L (mm)	T1/T2 (mm)	Ağırlık (kg/ad) Weight (kg/pcs)	Barkod Kodu Barcode Code
LT-12	120	3/1,5 mm	0,260	2003390

L = BOY = LENGTH / T = KALINLIK = THICKNESS

T = Kalınlık = Thickness = 1.50 mm

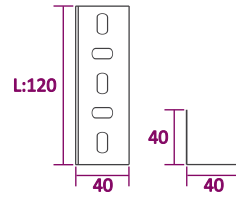

L KANAL TAŞIYICI (KAVRAMA) / L TYPE CEILING MOUNTING

Sipariş Kodu Order Code	L (mm)	T (mm)	Ağırlık (kg/ad) Weight (kg/pcs)	Barkod Kodu Barcode Code
LKK 100	105	1.50 mm	0,217	2003391
LKK 200	205	1.50 mm	0,267	2003392

PG

SD / HDG

Sipariş Kodu Order Code	L (mm)	T (mm)	Ağırlık (kg/ad) Weight (kg/pcs)	Barkod Kodu Barcode Code
LKK 100	105	1.50 mm	0,240	2003391
LKK 200	205	1.50 mm	0,294	2003392

L = BOY = LENGTH / T = KALINLIK = THICKNESS

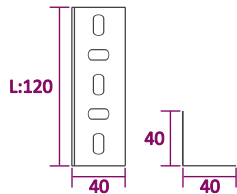

ARTIM METAL ELEKTRİK A.Ş.

* Farklı kalınlık ve ölçülerde üretim yapılabılır.
* Malzeme ağırlıkları yaklaşık değerlerdir, ± %10 değişiklik gösterebilir.
* Malzeme kalınlık toleransı ± %10 dur.
* Lütfen siparişlerinizde sipariş kodu veya ürün kodu ve kaplama şeklini belirtiniz.

* We can produce cable trays different thickness and dimensions
* Cable trays are shown approximately weight, they could change ± %10 difference.
* Cable trays thickness tolerances are shown ± %10 .
* Please indicate order code and coating type in your orders.

DS SERIES

DESTEK SİSTEMİ

SUPPORT SYSTEM

PREGALVANİZ (PG)
PREGALVANIZED (PG)
TS EN 10346

SICAK DALDIRMA (SD)
HOT DIP GALVANIZED (HDG)
TS EN ISO 1461

TİJLİ TAVAN TESPİT / CEILING INSTALLATION (THREADED ROD FOR)

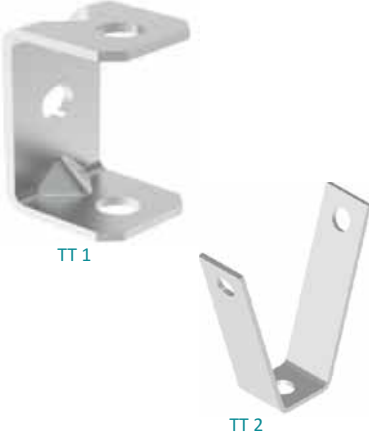

Paket Miktarı = 250 AD
Package Content = 250 PCS

Sipariş Kodu Order Code	T (mm)	Ağırlık (kg/ad) Weight (kg/pcs)	Barkod Kodu Barcode Code
TT1	3.00 mm	0,095	2003400
TT2	3.00 mm	0,162	2003401

Sipariş Kodu Order Code	T (mm)	Ağırlık (kg/ad) Weight (kg/pcs)	Barkod Kodu Barcode Code
TT1	3.00 mm	0,105	2003400
TT2	3.00 mm	0,169	2003401

T = KALINLIK = THICKNESS

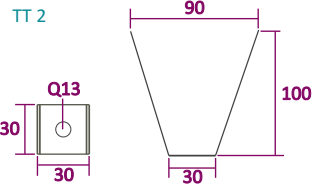
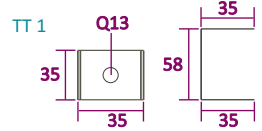

TİJLİ KANAL TAŞIYICI (U) / CABLE TRAY CARRIER (THREADED ROD FOR)



Sipariş Kodu Order Code	L (mm)	T (mm)	Ağırlık (kg/ad) Weight (kg/pcs)	Barkod Kodu Barcode Code
UTK 100	148	1.50 mm	0,145	2003455
UTK 120	183	1.50 mm	0,178	2003456
UTK 160	218	1.50 mm	0,292	2003457
UTK 200	253	1.50 mm	0,341	2003458
UTK 300	358	1.50 mm	0,349	2003459
UTK 400	463	2.00 mm	0,601	2003460
UTK 500	568	2.00 mm	0,738	2003461
UTK 600	673	2.00 mm	0,874	2003462

Sipariş Kodu Order Code	L (mm)	T (mm)	Ağırlık (kg/ad) Weight (kg/pcs)	Barkod Kodu Barcode Code
UTK 100	148	1.50 mm	0,160	2003455
UTK 120	183	1.50 mm	0,196	2003456
UTK 160	218	1.50 mm	0,321	2003457
UTK 200	253	1.50 mm	0,375	2003458
UTK 300	358	1.50 mm	0,384	2003459
UTK 400	463	2.00 mm	0,661	2003460
UTK 500	568	2.00 mm	0,812	2003461
UTK 600	673	2.00 mm	0,961	2003462

L = BOY = LENGTH / T = KALINLIK = THICKNESS

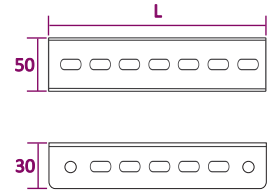

* Farklı kalınlık ve ölçülerde üretim yapılabılır.
* Malzeme ağırlıkları yaklaşık değerlerdir, ± %10 değişiklik gösterebilir.
* Malzeme kalınlık toleransı ± %10 dur.
* Lütfen siparişlerinizde sipariş kodu veya ürün kodu ve kaplama şeklini belirtiniz.

* We can produce cable trays different thickness and dimensions
* Cable trays are shown approximately weight, they could change ± %10 difference.
* Cable trays thickness tolerances are shown ± %10 .
* Please indicate order code and coating type in your orders.

DS SERIES

DESTEK SİSTEMİ

SUPPORT SYSTEM

PREGALVANİZ (PG)
PREGALVANIZED (PG)
TS EN 10346

SICAK DALDIRMA (SD)
HOT DIP GALVANIZED (HDG)
TS EN ISO 1461

TİJLİ KANAL TAŞIYICI / CABLE TRAY CARRIER (THREADED ROD FOR)



Sipariş Kodu Order Code	L (mm)	T (mm)	Ağırlık (kg/ad) Weight (kg/pcs)	Barkod Kodu Barcode Code
TK 050	55	1.50 mm	0,075	2003450
TK 100	105	1.50 mm	0,095	2003451
TK 120	125	1.50 mm	0,105	2003452
TK 160	165	1.50 mm	0,125	2003453
TK 200	205	1.50 mm	0,145	2003454

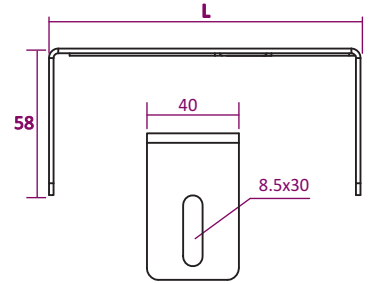

Sipariş Kodu Order Code	L (mm)	T (mm)	Ağırlık (kg/ad) Weight (kg/pcs)	Barkod Kodu Barcode Code
TK 050	55	1.50 mm	0,125	2003450
TK 100	105	1.50 mm	0,160	2003451
TK 120	125	1.50 mm	0,125	2003452
TK 160	165	1.50 mm	0,183	2003453
TK 200	205	1.50 mm	0,240	2003454

SD / HDG

Paket Miktarı (ad) Package Content (pcs)	
TK 050	200
TK 100	160
TK 120	-
TK 160	-
TK 200	75

L = BOY = LENGTH / T = KALINLIK = THICKNESS

TİJLİ KANAL TAŞIYICI / CABLE TRAY CARRIER (THREADED ROD FOR)



Sipariş Kodu Order Code	L (mm)	T (mm)	Ağırlık (kg/ad) Weight (kg/pcs)	Barkod Kodu Barcode Code
LT-1	40	3.00 mm	0,075	2003465
LT-2	50	3.00 mm	0,082	2003467
LT-3	60	3.00 mm	0,095	2003466
LT-4	80	3.00 mm	0,126	2003468
LT-5	100	3.00 mm	0,158	2003469

PG

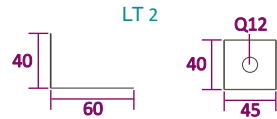
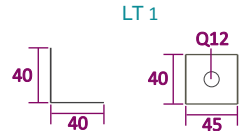

Sipariş Kodu Order Code	L (mm)	T (mm)	Ağırlık (kg/ad) Weight (kg/pcs)	Barkod Kodu Barcode Code
LT-1	40	3.00 mm	0,080	2003465
LT-2	50	3.00 mm	0,095	2003467
LT-3	60	3.00 mm	0,105	2003466
LT-4	80	3.00 mm	0,140	2003468
LT-5	100	3.00 mm	0,175	2003469

SD / HDG

Paket Miktarı (ad) Package Content (pcs)	
LT-1	300
LT-2	-
LT-3	200
LT-4	-
LT-5	-

L = BOY = LENGTH / T = KALINLIK = THICKNESS

ARTIM METAL ELEKTRİK A.Ş.

* Farklı kalınlık ve ölçülerde üretim yapılabılır.
* Malzeme ağırlıkları yaklaşık değerlerdir, \pm %10 değişiklik gösterebilir.
* Malzeme kalınlık toleransı \pm %10 dur.
* Lütfen siparişlerinizde sipariş kodu veya ürün kodu ve Kaplama şeklini belirtiniz.

* We can produce cable trays different thickness and dimensions
* Cable trays are shown approximately weight, they could change \pm %10 difference.
* Cable trays thickness tolerances are shown \pm %10 .
* Please indicate order code and coating type in your orders.

DS SERIES

DESTEK SİSTEMİ

SUPPORT SYSTEM

PREGALVANİZ (PG)
PREGALVANIZED (PG)
TS EN 10346

SICAK DALDIRMA (SD)
HOT DIP GALVANIZED (HDG)
TS EN ISO 1461

TİJLİ KANAL TAŞIYICI / CABLE TRAY CARRIER (THREADED ROD FOR)

PG

Sipariş Kodu Order Code	L (mm)	T (mm)	Ağırlık (kg/ad) Weight (kg/pcs)	Barkod Kodu Barcode Code
YT 100	105	3.00 mm	0,190	2003367
YT 120	125	3.00 mm	0,215	2003368
YT 160	165	3.00 mm	0,245	2003369
YT 200	205	3.00 mm	0,280	2003370

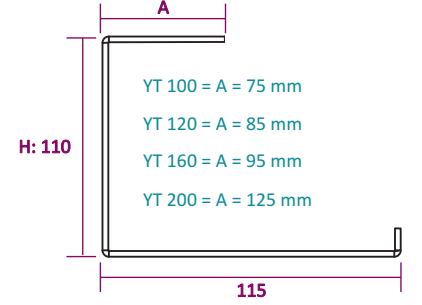

SD / HDG

Sipariş Kodu Order Code	L (mm)	T (mm)	Ağırlık (kg/ad) Weight (kg/pcs)	Barkod Kodu Barcode Code
YT 100	105	3.00 mm	0,210	2003367
YT 120	125	3.00 mm	0,240	2003368
YT 160	165	3.00 mm	0,270	2003369
YT 200	205	3.00 mm	0,310	2003370

L = BOY = LENGTH / T = KALINLIK = THICKNESS

H40 YERE DUVARA TESPİT ELEMANI / H40 WALL FLOOR FIXING ANGLE

PG

Sipariş Kodu Order Code	L (mm)	T (mm)	Ağırlık (kg/ad) Weight (kg/pcs)	Barkod Kodu Barcode Code
YD 100	100	3.00 mm	0,153	2003200
YD 200	200	3.00 mm	0,214	2003201
YD 300	300	3.00 mm	0,251	2003202
YD 400	400	3.00 mm	0,330	2003203
YD 500	500	3.00 mm	0,391	2003204
YD 600	600	3.00 mm	0,451	2003205

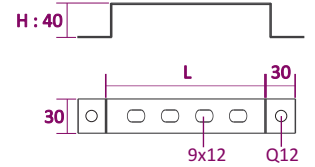

SD / HDG

Sipariş Kodu Order Code	L (mm)	T (mm)	Ağırlık (kg/ad) Weight (kg/pcs)	Barkod Kodu Barcode Code
YD 100	100	3.00 mm	0,165	2003200
YD 200	200	3.00 mm	0,230	2003201
YD 300	300	3.00 mm	0,270	2003202
YD 400	400	3.00 mm	0,355	2003203
YD 500	500	3.00 mm	0,420	2003204
YD 600	600	3.00 mm	0,485	2003205

L = BOY = LENGTH / T = KALINLIK = THICKNESS



* Farklı kalınlık ve ölçülerde üretim yapıla bilinir.
* Malzeme ağırlıkları yaklaşık değerlerdir, \pm %10 değişiklik gösterebilir.
* Malzeme kalınlık toleransı \pm %10 dur.
* Lütfen siparişlerinizde sipariş kodu veya ürün kodu ve Kaplama şeklini belirtiniz.

* We can produce cable trays different thickness and dimensions
* Cable trays are shown approximately weight, they could change \pm %10 difference.
* Cable trays thickness tolerances are shown \pm %10 .
* Please indicate order code and coating type in your orders.

DS SERIES

DESTEK SİSTEMİ

SUPPORT SYSTEM

PREGALVANİZ (PG)
PREGALVANIZED (PG)
TS EN 10346

SICAK DALDIRMA (SD)
HOT DIP GALVANIZED (HDG)
TS EN ISO 1461

H60 YERE DUVARA TESPİT ELEMANI / H60 WALL FLOOR FIXING ANGLE

PG

Sipariş Kodu Order Code	L (mm)	T (mm)	Ağırlık (kg/ad) Weight (kg/pcs)	Barkod Kodu Barcode Code
YD 100 -60	100	3.00 mm	0,182	2003206
YD 200 -60	200	3.00 mm	0,243	2003207
YD 300-60	300	3.00 mm	0,280	2003208
YD 400-60	400	3.00 mm	0,359	2003209
YD 500-60	500	3.00 mm	0,420	2003210
YD 600-60	600	3.00 mm	0,480	2003211

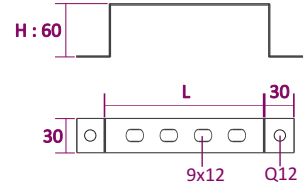

SD / HDG

Sipariş Kodu Order Code	L (mm)	T (mm)	Ağırlık (kg/ad) Weight (kg/pcs)	Barkod Kodu Barcode Code
YD 100 -60	100	3.00 mm	0,194	2003206
YD 200 -60	200	3.00 mm	0,259	2003207
YD 300-60	300	3.00 mm	0,299	2003208
YD 400-60	400	3.00 mm	0,384	2003209
YD 500-60	500	3.00 mm	0,449	2003210
YD 600-60	600	3.00 mm	0,514	2003211

L = BOY = LENGTH / T = KALINLIK = THICKNESS

H100 YERE DUVARA TESPİT ELEMANI / H100 WALL FLOOR FIXING ANGLE

PG

Sipariş Kodu Order Code	L (mm)	T (mm)	Ağırlık (kg/ad) Weight (kg/pcs)	Barkod Kodu Barcode Code
YD 100 -100	100	3.00 mm	0,239	2003212
YD 200 -100	200	3.00 mm	0,300	2003213
YD 300-100	300	3.00 mm	0,337	2003214
YD 400-100	400	3.00 mm	0,416	2003215
YD 500-100	500	3.00 mm	0,477	2003216
YD 600-100	600	3.00 mm	0,537	2003217

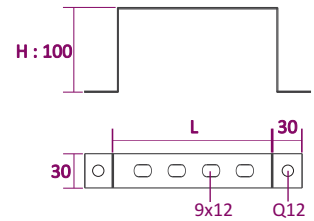

SD / HDG

Sipariş Kodu Order Code	L (mm)	T (mm)	Ağırlık (kg/ad) Weight (kg/pcs)	Barkod Kodu Barcode Code
YD 100 -100	100	3.00 mm	0,251	2003212
YD 200 -100	200	3.00 mm	0,316	2003213
YD 300-100	300	3.00 mm	0,356	2003214
YD 400-100	400	3.00 mm	0,441	2003215
YD 500-100	500	3.00 mm	0,506	2003216
YD 600-100	600	3.00 mm	0,571	2003217

L = BOY = LENGTH / T = KALINLIK = THICKNESS



ARTIM METAL ELEKTRİK A.Ş.

* Farklı kalınlık ve ölçülerde üretim yapılabılır.
* Malzeme ağırlıkları yaklaşık değerlerdir, \pm %10 değişiklik gösterebilir.
* Malzeme kalınlık toleransı \pm %10 dur.
* Lütfen siparişlerinizde sipariş kodu veya ürün kodu ve Kaplama şeklini belirtiniz.

* We can produce cable trays different thickness and dimensions
* Cable trays are shown approximately weight, they could change \pm %10 difference.
* Cable trays thickness tolerances are shown \pm %10 .
* Please indicate order code and coating type in your orders.

DS SERIES DESTEK SİSTEMİ SUPPORT SYSTEM

SICAK DALDIRMA (SD)

HOT DIP GALVANIZED (HDG)

TS EN ISO 1461

ORTA GERİLİM TAŞIYICILAR / MEDIUM VOLTAGE CARRIERS

SD / HDG

Sipariş Kodu Order Code	L (mm)	T1 (mm)	Ağırlık (kg/ad) Weight (kg/pcs)	Barkod Kodu Barcode Code
OG 200	200	2.00 mm	0,828	20039941

L = BOY = LENGTH / T = KALINLIK = THICKNESS

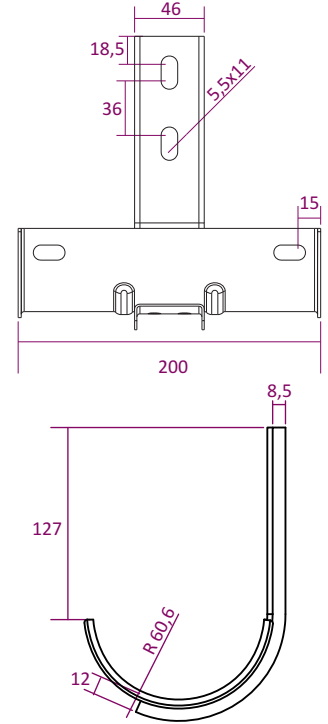

- Farklı kalınlık ve ölçülerde üretim yapılabılır.
- Malzeme ağırlıkları yaklaşık değerlerdir, \pm %10 değişiklik gösterebilir.
- Malzeme kalınlık toleransı \pm %10 dur.
- Lütfen siparişlerinizde sipariş kodu veya ürün kodu ve kaplama şeklini belirtiniz.

- We can produce cable trays different thickness and dimensions
- Cable trays are shown approximately weight, they could change \pm %10 difference.
- Cable trays thickness tolerances are shown \pm %10 .
- Please indicate order code and coating type in your orders.

DS SERIES

DESTEK SİSTEMİ

SUPPORT SYSTEM

PREGALVANİZ (PG)
PREGALVANIZED (PG)
TS EN 10346

SICAK DALDIRMA (SD)
HOT DIP GALVANIZED (HDG)
TS EN ISO 1461

KAYNAKSIZ DUVAR KONSOLLARI / SUPPORT FOR WALL MOUNTING (NO WELDED)



Sipariş Kodu Order Code	L (mm)	T (mm)	Ağırlık (kg/ad) Weight (kg/pcs)	Barkod Kodu Barcode Code
ART 050	60	1.50 mm	0,127	2003350
ART 100	110	1.50 mm	0,124	2003351
ART 120	130	1.50 mm	0,293	2003352
ART 160	170	1.50 mm	0,313	2003353
ART 200	210	1.50 mm	0,195	2003354
ART 300	310	1.50 mm	0,339	2003355
ART 400	410	2.00 mm	0,550	2003356
ART 500	510	2.00 mm	1,087	2003357
ART 600	610	2.00 mm	1,288	2003358

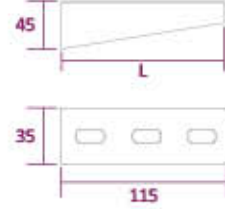

Sipariş Kodu Order Code	L (mm)	T (mm)	Ağırlık (kg/ad) Weight (kg/pcs)	Barkod Kodu Barcode Code
ART 050	60	1.50 mm	0,137	2003350
ART 100	110	1.50 mm	0,137	2003351
ART 120	130	1.50 mm	0,253	2003352
ART 160	170	1.50 mm	0,338	2003353
ART 200	210	1.50 mm	0,215	2003354
ART 300	310	1.50 mm	0,373	2003355
ART 400	410	2.00 mm	0,605	2003356
ART 500	510	2.00 mm	1,174	2003357
ART 600	610	2.00 mm	1,391	2003358

SD / HDG

Paket Miktarı (ad) Package Content (pcs)	Paket Miktarı (ad) Package Content (pcs)
ART 050	400
ART 100	120
ART 120	
ART 160	-
ART 200	80
ART 300	80
ART 400	80
ART 500	-
ART 600	-

L = BOY = LENGTH / T = KALINLIK = THICKNESS

KANAL TAŞIYICI / CABLE TRAY CARRIER



Sipariş Kodu Order Code	L (mm)	T1-T2 (mm)	Ağırlık (kg/ad) Weight (kg/pcs)	Barkod Kodu Barcode Code
30 ULT 200	200	2-3 mm	0,538	2003935
30 ULT 300	300	2-3 mm	0,644	2003936

L = BOY = LENGTH / T = KALINLIK = THICKNESS

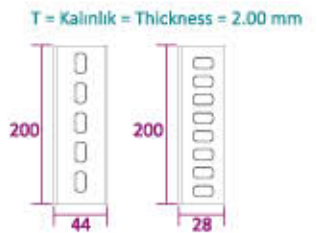
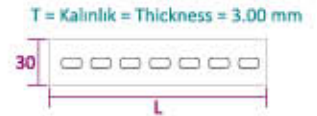

ARTIM METAL ELEKTRİK A.Ş.

- Farklı kalınlık ve ölçülerde üretim yapabiliriz.
- Malzeme ağırlıkları yaklaşık değerlerdir, \pm %10 değişiklik gösterebilir.
- Malzeme kalınlık toleransı \pm %10 dur.
- Lütfen siparişlerinizde sipariş kodu veya ürün kodu ve Kaplama şeklini belirtiniz.

- We can produce cable trays different thickness and dimensions
- Cable trays are shown approximately weight, they could change \pm %10 difference.
- Cable trays thickness tolerances are shown \pm %10 .
- Please indicate order code and coating type in your orders.

DS SERIES DESTEK SİSTEMİ SUPPORT SYSTEM

PREGALVANİZ (PG)
PREGALVANIZED (PG)
TS EN 10346

SICAK DALDIRMA (SD)
HOT DIP GALVANIZED (HDG)
TS EN ISO 1461

KAYNAKLI DUVAR KONSOLLARI / SUPPORT FOR WALL MOUNTING (WELDED)



Sipariş Kodu Order Code	L (mm)	T (mm)	Ağırlık (kg/ad) Weight (kg/pcs)	Barkod Kodu Barcode Code
ART 100-K	100	1.50 mm	0,192	2003300
ART 160-K	200	1.50 mm	0,295	2003301
ART 200-K	200	1.50 mm	0,295	2003301
ART 300-K	300	1.50 mm	0,505	2003302
ART 400-K	400	2.00 mm	0,900	2003303
ART 500-K	500	2.00 mm	1,010	2003304
ART 600-K	600	2.00 mm	1,172	2003305

PG

ART 100-K / ART 200-K
T = Kalınlık = Thickness = 3.00 mm / 1.50 mm

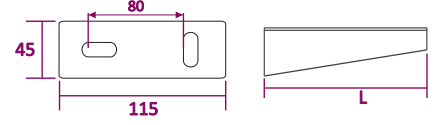

ART 300-K / ART 600-K
T = Kalınlık = Thickness = 4.00 mm / 2.00 mm

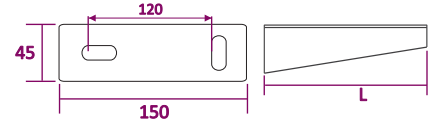

SD / HDG

Sipariş Kodu Order Code	L (mm)	T (mm)	Ağırlık (kg/ad) Weight (kg/pcs)	Barkod Kodu Barcode Code
ART 100-K	100	1.50 mm	0,207	2003300
ART 160-K	200	1.50 mm	0,318	2003301
ART 200-K	200	1.50 mm	0,318	2003301
ART 300-K	300	1.50 mm	0,543	2003302
ART 400-K	400	2.00 mm	0,968	2003303
ART 500-K	500	2.00 mm	1,086	2003304
ART 600-K	600	2.00 mm	1,261	2003305

Paket Miktarı (ad)

Package Content (pcs)

ART 100-K	70
ART 160-K	70
ART 200-K	70
ART 300-K	40
ART 400-K	35
ART 500-K	-
ART 600-K	-

L = BOY = LENGTH / T = KALINLIK = THICKNESS

TIJLİ KANAL TAŞIYICI / CABLE TRAY CARRIER (THREADED ROD FOR)

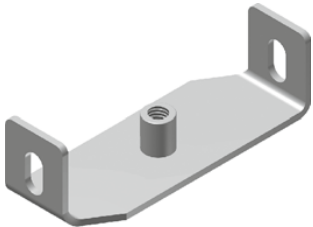

Sipariş Kodu Order Code	L (mm)	T (mm)	Ağırlık (kg/ad) Weight (kg/pcs)	Barkod Kodu Barcode Code
ASTK 100	105	1.50 mm	0,125	2003371
ASTK 120	125	1.50 mm	0,135	2003372
ASTK 160	165	1.50 mm	0,155	2003373
ASTK 200	205	1.50 mm	0,175	2003374

PG

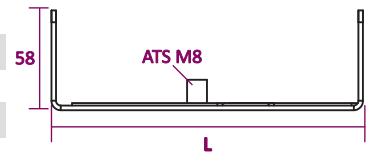

SD / HDG

Sipariş Kodu Order Code	L (mm)	T (mm)	Ağırlık (kg/ad) Weight (kg/pcs)	Barkod Kodu Barcode Code
ASTK 100	105	1.50 mm	0,190	2003371
ASTK 120	125	1.50 mm	0,155	2003372
ASTK 160	165	1.50 mm	0,213	2003373
ASTK 200	205	1.50 mm	0,270	2003374

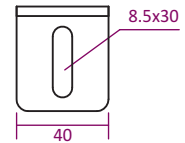

L = BOY = LENGTH / T = KALINLIK = THICKNESS

* Farklı kalınlık ve ölçülerde üretim yapılabılır.
* Malzeme ağırlıkları yaklaşık değerlerdir, ± %10 değişiklik gösterebilir.
* Malzeme kalınlık toleransı ± %10 dur.
* Lütfen siparişlerinizde sipariş kodu veya ürün kodu ve kaplama şeklini belirtiniz.

* We can produce cable trays different thickness and dimensions
* Cable trays are shown approximately weight, they could change ± %10 difference.
* Cable trays thickness tolerances are shown ± %10 .
* Please indicate order code and coating type in your orders.

DS SERIES

DESTEK SİSTEMİ

SUPPORT SYSTEM

PREGALVANİZ (PG)
PREGALVANIZED (PG)
TS EN 10346

SICAK DALDIRMA (SD)
HOT DIP GALVANIZED (HDG)
TS EN ISO 1461

DUVAR KONSOLLARI (AÇILI) / SUPPORT FOR WALL MOUNTING (ANGLED)



SD / HDG

Sipariş Kodu Order Code	L (mm)	T1-T2 (mm)	Ağırlık (kg/ad) Weight (kg/pcs)	Barkod Kodu Barcode Code
ART 300-KR (°)	300	2-3 mm	0,651	2003937
ART 400-KR (°)	400	2-4 mm	1,161	2003938
ART 500-KR (°)	500	2-4 mm	1,303	2003939
ART 600-KR (°)	600	2-4 mm	1,513	2003940

L = BOY = LENGTH / T = KALINLIK = THICKNESS

T = Kalınlık = Thickness = 4.00 mm

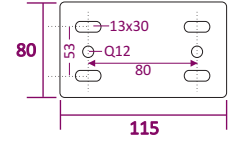

T = Kalınlık = Thickness = 2.00 mm

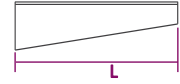

AĞIR HİZMET TİPİ KANAL TAŞIYICILAR / HEAVY DUTY CABLE TRAY CARRIERS



SD / HDG

Sipariş Kodu Order Code	L (mm)	T1 (mm)	Ağırlık (kg/ad) Weight (kg/pcs)	Barkod Kodu Barcode Code
50x40x250 NP	250	4.00 mm	5,008	20039942
50x40x350 NP	350	4.00 mm	5,285	20039942
50x40x450 NP	450	4.00 mm	5,561	20039942
50x40x550 NP	550	4.00 mm	5,837	20039942
50x40x650 NP	650	4.00 mm	6,113	20039942

L = BOY = LENGTH / T = KALINLIK = THICKNESS

Ağırlık Hesaplaması; Standart 50x50 lamadan 1.000 mm boyunda tek taşıyıcı.

Weight Calculation; Single carrier with a length of 1.000 mm from standard 50x50 plate.

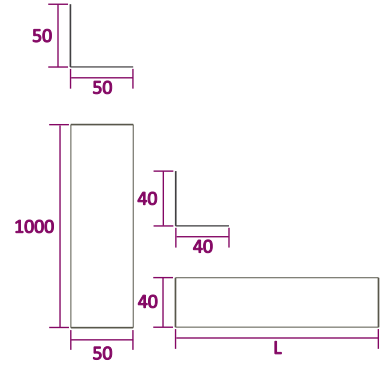

ARTIM METAL ELEKTRİK A.Ş.

- * Farklı kalınlık ve ölçülerde üretim yapılabılır.
- * Malzeme ağırlıkları yaklaşık değerlerdir, \pm %10 değişiklik gösterebilir.
- * Malzeme kalınlık toleransı \pm %10 dur.
- * Lütfen siparişlerinizde sipariş kodu veya ürün kodu ve Kaplama şeklini belirtiniz.

- * We can produce cable trays different thickness and dimensions
- * Cable trays are shown approximately weight, they could change \pm %10 difference.
- * Cable trays thickness tolerances are shown \pm %10 .
- * Please indicate order code and coating type in your orders.

DS SERIES

DESTEK SİSTEMİ

SUPPORT SYSTEM

PREGALVANİZ (PG)
PREGALVANIZED (PG)
TS EN 10346

SICAK DALDIRMA (SD)
HOT DIP GALVANIZED (HDG)
TS EN ISO 1461

Z PROFİLLER / Z PROFILE



						PG
Sipariş Kodu Order Code	Ebat (mm) Size (mm)	L (mm)	T (mm)	Ağırlık (kg/mt) Weight (kg/mt)	Barkod Kodu Barcode Code	
Z 104-15	34x42x34	2.500	1.50 mm	1,075	2003252	
Z 104-20	34x42x34	2.500	2.00 mm	1,430	2003256	
Z 124-15	34x62x34	2.500	1.50 mm	1,240	2003253	
Z 124-20	34x62x34	2.500	2.00 mm	1,660	2003257	
Z 144-15	54x42x54	2.500	1.50 mm	1,420	2003254	
Z 144-20	54x42x54	2.500	2.00 mm	1,895	2003258	
Z 164-15	54x62x54	2.500	1.50 mm	1,600	2003255	
Z 164-20	54x62x54	2.500	2.00 mm	2,135	2003259	

						SD / HDG
Sipariş Kodu Order Code	Ebat (mm) Size (mm)	L (mm)	T (mm)	Ağırlık (kg/mt) Weight (kg/mt)	Barkod Kodu Barcode Code	
Z 104-15	34x42x34	2.500	1.50 mm	1,185	2003252	
Z 104-20	34x42x34	2.500	2.00 mm	1,575	2003256	
Z 124-15	34x62x34	2.500	1.50 mm	1,365	2003253	
Z 124-20	34x62x34	2.500	2.00 mm	1,825	2003257	
Z 144-15	54x42x54	2.500	1.50 mm	1,565	2003254	
Z 144-20	54x42x54	2.500	2.00 mm	2,085	2003258	
Z 164-15	54x62x54	2.500	1.50 mm	1,760	2003255	
Z 164-20	54x62x54	2.500	2.00 mm	2,350	2003259	

L = BOY = LENGTH / T = KALINLIK = THICKNESS

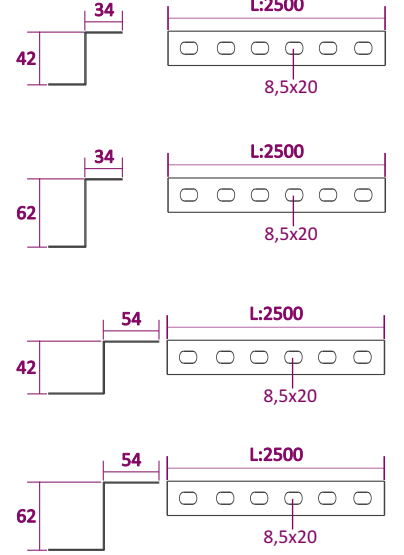

* Farklı kalınlık ve ölçülerde üretim yapılabılır.
* Malzeme ağırlıkları yaklaşık değerlerdir, \pm %10 değişiklik gösterebilir.
* Malzeme kalınlık toleransı \pm %10 dur.
* Lütfen siparişlerinizde sipariş kodu veya ürün kodu ve kaplama şeklini belirtiniz.

* We can produce cable trays different thickness and dimensions
* Cable trays are shown approximately weight, they could change \pm %10 difference.
* Cable trays thickness tolerances are shown \pm %10 .
* Please indicate order code and coating type in your orders.

DS SERIES

DESTEK SİSTEMİ

SUPPORT SYSTEM



KOD / CODE

KATALOG SAYFA CATALOG PAGE

1. UP 100	... U PROFİL / U PROFILE	210
2. US 300	... U KONSOL / U BRACKETS	214
3. 60 AGH 300	... KABLO KANALI / CABLE TRAYS	45
4. CSD-2	... DÜBEL / WALL PEG	295
5. CV-2	... M8 CİVATA / M8 BOLTS	292
6. ASN-1	... M8 SOMUN / NUTS	293

KOD / CODE

KATALOG SAYFA CATALOG PAGE

1. UPT-100	... U TAVAN / U CEILING	214
2. UP 100	... U PROFİL / U PROFILE	210
3. 40 AGH 300	... KABLO KANALI / CABLE TRAYS	26
4. CSD-2	... DÜBEL / WALL PEG	295
5. CV-2	... M8 CİVATA / M8 BOLTS	292
6. ASN-1	... M8 SOMUN / NUTS	293

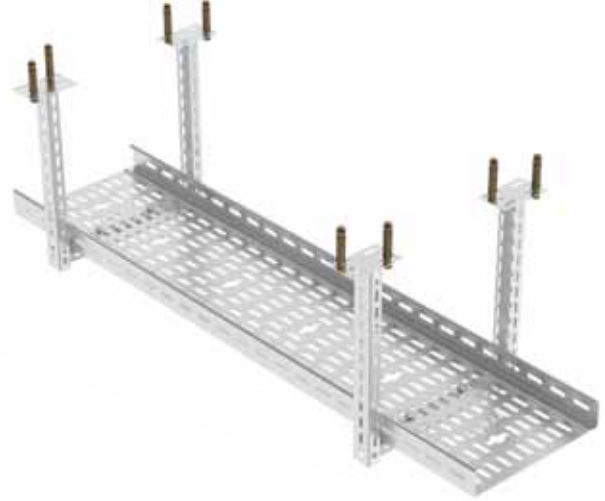

KOD / CODE

KATALOG SAYFA CATALOG PAGE

1. UPG	... U TAVAN / U CEILING	211
2. UP 100	... U PROFİL / U PROFILE	210
3. US 300	... U KONSOL / U BRACKETS	214
4. 60 AGH 300	... KABLO KANALI / CABLE TRAYS	45
5. CSD-2	... DÜBEL / WALL PEG	295
6. CV-2	... M8 CİVATA / M8 BOLTS	292
7. ASN-1	... M8 SOMUN / NUTS	293



ARTIM METAL ELEKTRİK A.Ş.

* Farklı kalınlık ve ölçülerde üretim yapılabılır.
* Malzeme ağırlıkları yaklaşık değerlerdir, \pm %10 değişiklik gösterebilir.
* Malzeme kalınlık toleransı \pm %10 dur.
* Lütfen siparişlerinizde sipariş kodu veya ürün kodu ve kaplama şeklini belirtiniz.

* We can produce cable trays different thickness and dimensions
* Cable trays are shown approximately weight, they could change \pm %10 difference.
* Cable trays thickness tolerances are shown \pm %10 .
* Please indicate order code and coating type in your orders.

DS SERIES

DESTEK SİSTEMİ

SUPPORT SYSTEM



KOD / CODE

KATALOG SAYFA CATALOG PAGE

1. ART 300-K	... D.KONSOL / WALL MOUNTING	211
2. 60 AGH 300	... KABLO KANALI / CABLE TRAYS	45
3. 60 AST 1	... EK / CONNECTION	110
4. CSD-2	... DÜBEL / WALL PEG	295
5. CV-2	... M8 CİVATA / M8 BOLTS	292
6. ASN-1	... M8 SOMUN / NUTS	293

KOD / CODE

KATALOG SAYFA CATALOG PAGE

1. IDT-2	... I TAVAN / I CEILING	236
2. ID 80-100	... I PROFİL / I PROFILE	231
3. IDK 200	... I KONSOL / I BRACKETS	233
4. AAC-2	... M10 CİVATA / M10 BOLTS	292
5. ASN-2	... M10 SOMUN / M10 NUTS	293
6. IDK-EK	... I KONSOL EK / I CONSOLE CONNECTION	293
7. 40 AAU 100	... KABLO KANALI / CABLE TRAYS	2
8. CSD-2	... DÜBEL / WALL PEG	295
9. CV-2	... M8 CİVATA / M8 BOLTS	292
10. ASN-1	... M8 SOMUN / NUTS	293

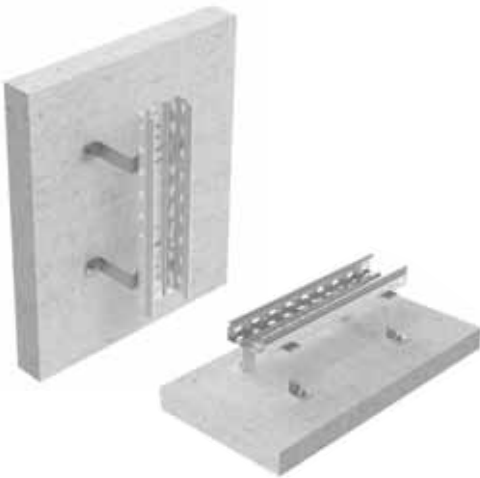

KOD / CODE

KATALOG SAYFA CATALOG PAGE

1. YD 100-60	... Y.D.TESPİT / W.F.FIXING	222
2. 40 AAU 100	... KABLO KANALI / CABLE TRAYS	2
3. CSD-2	... DÜBEL / WALL PEG	295
4. CV-2	... M8 CİVATA / M8 BOLTS	292
5. ASN-1	... M8 SOMUN / NUTS	293

* Farklı kalınlık ve ölçülerde üretim yapılabılır.
* Malzeme ağırlıkları yaklaşık değerlerdir, \pm %10 değişiklik gösterebilir.
* Malzeme kalınlık toleransı \pm %10 dur.
* Lütfen siparişlerinizde sipariş kodu veya ürün kodu ve kaplama şeklini belirtiniz.

* We can produce cable trays different thickness and dimensions
* Cable trays are shown approximately weight, they could change \pm %10 difference.
* Cable trays thickness tolerances are shown \pm %10 .
* Please indicate order code and coating type in your orders.

DS SERIES

DESTEK SİSTEMİ

SUPPORT SYSTEM



KOD / CODE

KATALOG SAYFA CATALOG PAGE

1.	TT1	... TİJLİ TAVAN/ROD CEILING	219
2.	AT-1	... TİJ / ROD	294
3.	ASN-1	... SOMUN / NUTS	293
4.	UTK 200	... TİJLİ TAŞIYICI / ROD CARRIER	219
5.	CSD-2	... DÜBEL / WALL PEG	295
6.	40 AAU 200	... KABLO KANALI / CABLE TRAYS	2
7.	CV-2	... M8 CİVATA / M8 BOLTS	292
8.	ASN-1	... M8 SOMUN / NUTS	293

KOD / CODE

KATALOG SAYFA CATALOG PAGE

1.	AT-1	... TİJ / ROD	294
2.	ASN-1	... SOMUN / NUTS	293
3.	TK 100	... TİJLİ TAŞIYICI/ROD CARRIER	220
4.	40 AAU 100	... KABLO KANALI / CABLE TRAYS	2
5.	CV-2	... M8 CİVATA / M8 BOLTS	292
6.	ASN-1	... M8 SOMUN / NUTS	293



KOD / CODE

KATALOG SAYFA CATALOG PAGE

1.	UPG	... U TAVAN / U CEILING	211
2.	UP 100	... U PROFİL / U PROFILE	210
3.	30 ULT 300	... KANAL TAŞIYICI/TRAY CARRIER	224
4.	40 AST 300	... KABLO KANALI / CABLE TRAYS	31
5.	CSD-2	... DÜBEL / WALL PEG	295
5.	CV-2	... M8 CİVATA / M8 BOLTS	292
5.	ASN-1	... M8 SOMUN / NUTS	293

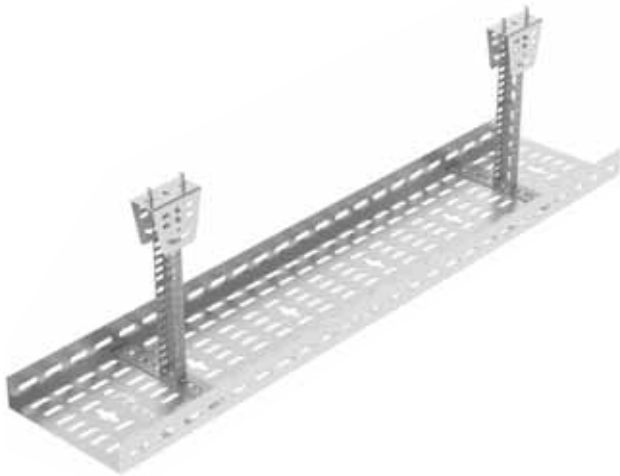

ARTIM METAL ELEKTRİK A.Ş.

* Farklı kalınlık ve ölçülerde üretim yapılabılır.
* Malzeme ağırlıkları yaklaşık değerlerdir, \pm %10 değişiklik gösterebilir.
* Malzeme kalınlık toleransı \pm %10 dur.
* Lütfen siparişlerinizde sipariş kodu veya ürün kodu ve Kaplama şeklini belirtiniz.

* We can produce cable trays different thickness and dimensions
* Cable trays are shown approximately weight, they could change \pm %10 difference.
* Cable trays thickness tolerances are shown \pm %10 .
* Please indicate order code and coating type in your orders.

DS SERIES

DESTEK SİSTEMİ

SUPPORT SYSTEM

SICAK DALDIRMA (SD)

HOT DIP GALVANIZED (HDG)

TS EN ISO 1461

I PROFİLLER / I PROFILE

SD / HDG

Sipariş Kodu Order Code	L (mm)	T (mm)	Ağırlık (kg/ad) Weight (kg/pcs)	Barkod Kodu Barcode Code
ID 80-020	200	4.00 mm	1,290	2003500
ID 80-030	300	4.00 mm	1,930	2003501
ID 80-040	400	4.00 mm	2,575	2003502
ID 80-050	500	4.00 mm	3,220	2003503
ID 80-060	600	4.00 mm	3,865	2003504
ID 80-070	700	4.00 mm	4,505	2003505
ID 80-080	800	4.00 mm	5,150	2003506
ID 80-090	900	4.00 mm	5,790	2003507
ID 80-100	1.000	4.00 mm	6,435	2003508
ID 80-110	1.100	4.00 mm	7,080	2003509
ID 80-120	1.200	4.00 mm	7,725	2003510
ID 80-130	1.300	4.00 mm	8,365	2003511
ID 80-140	1.400	4.00 mm	9,000	2003512
ID 80-150	1.500	4.00 mm	9,655	2003513
ID 80-160	1.600	4.00 mm	10,300	2003514
ID 80-170	1.700	4.00 mm	10,940	2003515
ID 80-180	1.800	4.00 mm	11,585	2003516
ID 80-190	1.900	4.00 mm	12,230	2003517
ID 80-200	2.000	4.00 mm	12,870	2003518
ID 80-300	3.000	4.00 mm	19,305	2003519

L = BOY = LENGTH / T = KALINLIK = THICKNESS

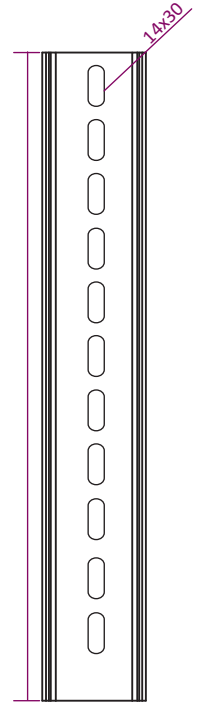
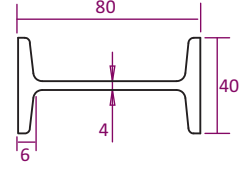

- * Farklı kalınlık ve ölçülerde üretim yapılabılır.
- * Malzeme ağırlıkları yaklaşık değerlerdir, \pm %10 değişiklik gösterebilir.
- * Malzeme kalınlık toleransı \pm %10 dur.
- * Lütfen siparişlerinizde sipariş kodu veya ürün kodu ve kaplama şeklini belirtiniz.

- * We can produce cable trays different thickness and dimensions
- * Cable trays are shown approximately weight, they could change \pm %10 difference.
- * Cable trays thickness tolerances are shown \pm %10 .
- * Please indicate order code and coating type in your orders.

DS SERIES

DESTEK SİSTEMİ

SUPPORT SYSTEM

SICAK DALDIRMA (SD)

HOT DIP GALVANIZED (HDG)

TS EN ISO 1461

I PROFİL TAVAN DESTEK ELEMANI / I SUPPORT FOR CEILING MOUNTING

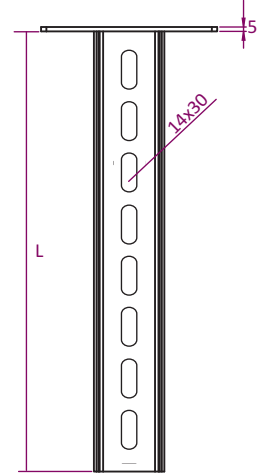
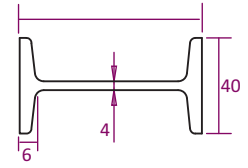
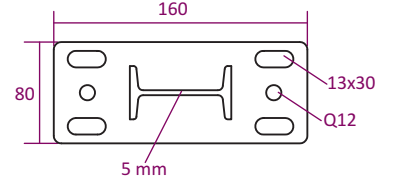

Sipariş Kodu Order Code	L (mm)	T (mm)	Ağırlık (kg/ad) Weight (kg/pcs)	Barkod Kodu Barcode Code
IDT 80-020	200	4.00 mm	1,890	2003600
IDT 80-030	300	4.00 mm	2,428	2003601
IDT 80-040	400	4.00 mm	3,028	2003602
IDT 80-050	500	4.00 mm	3,628	2003603
IDT 80-060	600	4.00 mm	4,228	2003604
IDT 80-070	700	4.00 mm	5,047	2003605
IDT 80-080	800	4.00 mm	5,692	2003606
IDT 80-090	900	4.00 mm	6,332	2003607
IDT 80-100	1.000	4.00 mm	6,977	2003608
IDT 80-110	1.100	4.00 mm	7,622	2003609
IDT 80-120	1.200	4.00 mm	8,267	2003610
IDT 80-130	1.300	4.00 mm	8,907	2003611
IDT 80-140	1.400	4.00 mm	9,542	2003612
IDT 80-150	1.500	4.00 mm	10,197	2003613
IDT 80-160	1.600	4.00 mm	10,842	2003614
IDT 80-170	1.700	4.00 mm	11,482	2003615
IDT 80-180	1.800	4.00 mm	12,127	2003616
IDT 80-190	1.900	4.00 mm	12,772	2003617
IDT 80-200	2.000	4.00 mm	13,412	2003618
IDT 80-300	3.000	4.00 mm	19,847	2003619

L = BOY = LENGTH / T = KALINLIK = THICKNESS



ARTIM METAL ELEKTRİK A.Ş.

- * Farklı kalınlık ve ölçülerde üretim yapılabılır.
- * Malzeme ağırlıkları yaklaşık değerlerdir, \pm %10 değişiklik gösterebilir.
- * Malzeme kalınlık toleransı \pm %10 dur.
- * Lütfen siparişlerinizde sipariş kodu veya ürün kodu ve Kaplama şeklini belirtiniz.

- * We can produce cable trays different thickness and dimensions
- * Cable trays are shown approximately weight, they could change \pm %10 difference.
- * Cable trays thickness tolerances are shown \pm %10 .
- * Please indicate order code and coating type in your orders.

DS SERIES DESTEK SİSTEMİ SUPPORT SYSTEM

SICAK DALDIRMA (SD)

HOT DIP GALVANIZED (HDG)

TS EN ISO 1461

I PROFİL KONSOLLARI / I SUPPORT BRACKETS

SD / HDG

Sipariş Kodu Order Code	L (mm)	T (mm)	Ağırlık (kg/ad) Weight (kg/pcs)	Barkod Kodu Barcode Code
IDK 100	120	2.00 mm	0,325	2003650
IDK 200	220	2.00 mm	0,540	2003651
IDK 300	320	2.00 mm	0,748	2003652
IDK 400	420	2.00 mm	0,894	2003653
IDK 500	520	2.00 mm	1,092	2003654
IDK 600	620	2.00 mm	1,290	2003655
IDK 400 -3	420	3.00 mm	1,341	2003653
IDK 500 -3	520	3.00 mm	1,638	2003654
IDK 600 -3	620	3.00 mm	1,935	2003655

L = BOY = LENGTH / T = KALINLIK = THICKNESS

IDK 100 / IDK 200

- 1 Adet IDK-EK Konsol kelepçesi
- 1 Adet AAC-2 M10x25 Anahtar Başlı Civata
- 1 Adet ASN-2 M10 Somun kullanılmaktadır.
- 1 Piece IDK-EK Console clamp
- 1 Piece AAC-2 M10x25 Key Head Bolt
- 1 Piece ASN-2 M10 Nut It is used.

IDK 300 / IDK 400 / IDK 500 / IDK 600

- 2 Adet IDK-EK Konsol kelepçesi
- 2 Adet AAC-2 M10x25 Anahtar Başlı Civata
- 2 Adet ASN-2 M10 Somun kullanılmaktadır.
- 2 Piece IDK-EK Console clamp
- 2 Piece AAC-2 M10x25 Key Head Bolt
- 2 Piece ASN-2 M10 Nut It is used.

I KONSOL BAĞLANTI / I CONSOLE CONNECTION

SD / HDG

Sipariş Kodu Order Code	L (mm)	T (mm)	Ağırlık (kg/ad) Weight (kg/pcs)	Barkod Kodu Barcode Code
IDK-EK	55	4.00 mm	0,160	2003664

L = BOY = LENGTH / T = KALINLIK = THICKNESS

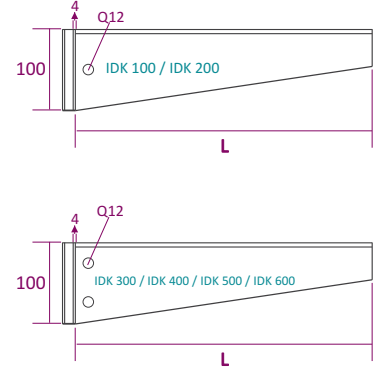

IDK-EK



AAC-2
(M10x25)

ASN-2
(M10)

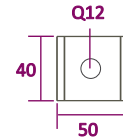

Bu ürün ayrı satılmaktadır.
IDK 100 / IDK 200 için tek bir ürün kullanılır.
IDK 300 / IDK 600 için iki ürün kullanılır.
This product is sold separately.
A single product is used for IDK 100 / IDK 200.
Two products are used for the IDK 300 / IDK 600.

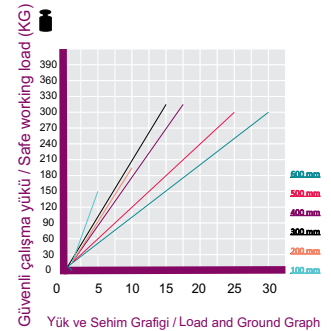

* Farklı kalınlık ve ölçülerde üretim yapılabılır.
* Malzeme ağırlıkları yaklaşık değerlerdir, ± %10 değişiklik gösterebilir.
* Malzeme kalınlık toleransı ± %10 dur.
* Lütfen siparişlerinizde sipariş kodu veya ürün kodu ve Kaplama şeklini belirtiniz.

* We can produce cable trays different thickness and dimensions
* Cable trays are shown approximately weight, they could change ± %10 difference.
* Cable trays thickness tolerances are shown ± %10 .
* Please indicate order code and coating type in your orders.

DS SERIES

DESTEK SİSTEMİ

SUPPORT SYSTEM

SICAK DALDIRMA (SD)
HOT DIP GALVANIZED (HDG)
TS EN ISO 1461

I PROFİL EK ELEMANI / I SUPPORT STRAIGHT COUPLER



SD / HDG

Sipariş Kodu Order Code	L (mm)	T (mm)	Ağırlık (kg/ad) Weight (kg/pcs)	Barkod Kodu Barcode Code
ID-EK	215	3.00 mm	0,395	2003661

L = BOY = LENGTH / T = KALINLIK = THICKNESS

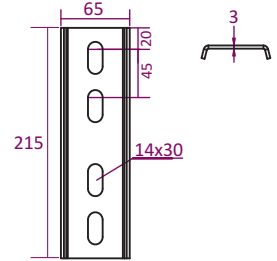

I PROFİL SONLANDIRMA / I PROFILE AND COVER



PLASTIC

Sipariş Kodu Order Code	L (mm)	H (mm)	Ağırlık (kg/ad) Weight (kg/pcs)	Barkod Kodu Barcode Code
IPS 80	83	45	0,015	2003660

L = BOY = LENGTH / H = YÜKSEKLİK = HEIGHT / T = KALINLIK = THICKNESS

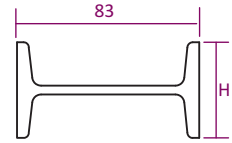

I PROFİL TESPİT KELEPÇESİ / I PROFILE FIXING CLAMPS



SD / HDG

Sipariş Kodu Order Code	L (mm)	T (mm)	Ağırlık (kg/ad) Weight (kg/pcs)	Barkod Kodu Barcode Code
IDT-7	60	4.00 mm	0,155	2003469

L = BOY = LENGTH / T = KALINLIK = THICKNESS



ARTIM METAL ELEKTRİK A.Ş.

- * Farklı kalınlık ve ölçülerde üretim yapılabılır.
- * Malzeme ağırlıkları yaklaşık değerlerdir, \pm %10 değişiklik gösterebilir.
- * Malzeme kalınlık toleransı \pm %10 dur.
- * Lütfen siparişlerinizde sipariş kodu veya ürün kodu ve kaplama şeklini belirtiniz.

- * We can produce cable trays different thickness and dimensions
- * Cable trays are shown approximately weight, they could change \pm %10 difference.
- * Cable trays thickness tolerances are shown \pm %10 .
- * Please indicate order code and coating type in your orders.

DS SERIES DESTEK SİSTEMİ SUPPORT SYSTEM

SICAK DALDIRMA (SD)

HOT DIP GALVANIZED (HDG)

TS EN ISO 1461

I PROFİL TESPİT KELEPÇESİ / I PROFILE FIXING CLAMPS

SD / HDG

Sipariş Kodu Order Code	H (mm)	T (mm)	Ağırlık (kg/ad) Weight (kg/pcs)	Barkod Kodu Barcode Code
IDT-3	10	4.00 mm	0,515	2003665
IDT-4	15	4.00 mm	0,530	2003666
IDT-5	20	4.00 mm	0,545	2003667
IDT-6	25	4.00 mm	0,565	2003668

H = YÜKSEKLİK = HEIGHT / T = KALINLIK = THICKNESS

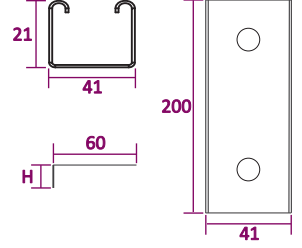

I PROFİL TESPİT KELEPÇESİ / I PROFILE FIXING CLAMPS

SD / HDG

Sipariş Kodu Order Code	L (mm)	T (mm)	Ağırlık (kg/ad) Weight (kg/pcs)	Barkod Kodu Barcode Code
IDT-8	50	4.00 mm	0,205	2003470

L = BOY = LENGTH / T = KALINLIK = THICKNESS

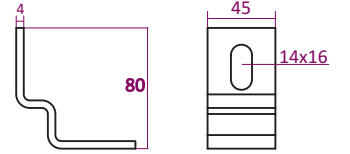

I PROFİL TESPİT KELEPÇESİ / I PROFILE FIXING CLAMPS

SD / HDG

Sipariş Kodu Order Code	L (mm)	T (mm)	Ağırlık (kg/ad) Weight (kg/pcs)	Barkod Kodu Barcode Code
IDT-9	40	4.00 mm	0,195	2003471

L = BOY = LENGTH / T = KALINLIK = THICKNESS

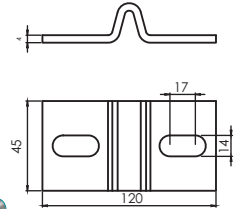

IDT-9



IDT-8

- * Farklı kalınlık ve ölçülerde üretim yapılabılır.
- * Malzeme ağırlıkları yaklaşık değerlerdir, \pm %10 değişiklik gösterebilir.
- * Malzeme kalınlık toleransı \pm %10 dur.
- * Lütfen siparişlerinizde sipariş kodu veya ürün kodu ve Kaplama şeklini belirtiniz.

- * We can produce cable trays different thickness and dimensions
- * Cable trays are shown approximately weight, they could change \pm %10 difference.
- * Cable trays thickness tolerances are shown \pm %10 .
- * Please indicate order code and coating type in your orders.

DS SERIES

DESTEK SİSTEMİ

SUPPORT SYSTEM

SICAK DALDIRMA (SD)

HOT DIP GALVANIZED (HDG)

TS EN ISO 1461

I PROFİL TAVAN DESTEK ELEMANI / I SUPPORT FOR CEILING MOUNTING



Sipariş Kodu Order Code	L (mm)	T (mm)	Ağırlık (kg/ad) Weight (kg/pcs)	Barkod Kodu Barcode Code
IDT-1	140	3.00 mm	0,945	2003662

L = BOY = LENGTH / T = KALINLIK = THICKNESS

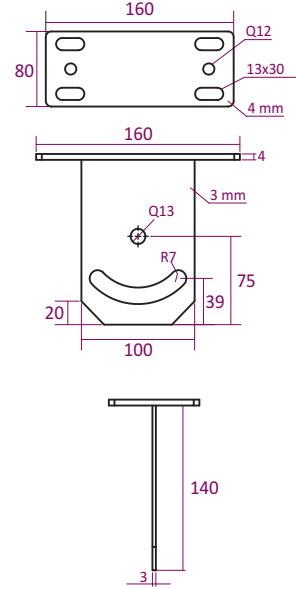

I PROFİL TAVAN DESTEK ELEMANI / I SUPPORT FOR CEILING MOUNTING



Sipariş Kodu Order Code	L (mm)	T (mm)	Ağırlık (kg/ad) Weight (kg/pcs)	Barkod Kodu Barcode Code
IDT-2-K	140	3.00 mm	1,164	2003663
IDT-2-U	215	3.00 mm	1,410	2003663

L = BOY = LENGTH / T = KALINLIK = THICKNESS

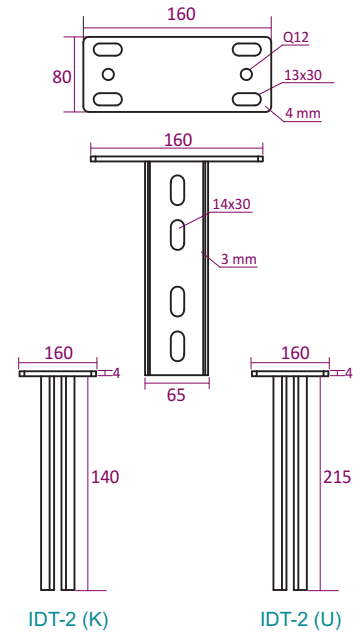

ARTIM METAL ELEKTRİK A.Ş.

- * Farklı kalınlık ve ölçülerde üretim yapılabılır.
- * Malzeme ağırlıkları yaklaşık değerlerdir, \pm %10 değişiklik gösterebilir.
- * Malzeme kalınlık toleransı \pm %10 dur.
- * Lütfen siparişlerinizde sipariş kodu veya ürün kodu ve Kaplama şeklini belirtiniz.

- * We can produce cable trays different thickness and dimensions
- * Cable trays are shown approximately weight, they could change \pm %10 difference.
- * Cable trays thickness tolerances are shown \pm %10 .
- * Please indicate order code and coating type in your orders.

DS SERIES

DESTEK SİSTEMİ

SUPPORT SYSTEM

SICAK DALDIRMA (SD)

HOT DIP GALVANIZED (HDG)

TS EN ISO 1461

EŞKENAR KÖŞEBENT / EQUAL ANGLES

SD / HDG

Sipariş Kodu Order Code	W (mm)	T (mm)	Ağırlık (kg/mt) Weight (kg/mt)	Barkod Kodu Barcode Code
L 40x40x4	40	4.00 mm	2,497	2003950
L 40x40x4D	40	4.00 mm	2,008	2003951
L 50x50x5	50	5.00 mm	3,867	2003952
L 50x50x5D	50	5.00 mm	3,259	2003953

W = GENİŞLİK = WIDTH / T = KALINLIK = THICKNESS

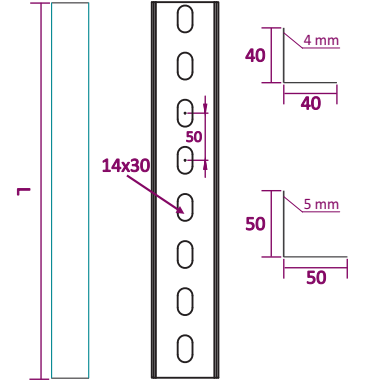

NPU PROFİLLER / NPU PROFILES

SD / HDG

Sipariş Kodu Order Code	W (mm)	T (mm)	Ağırlık (kg/mt) Weight (kg/mt)	Barkod Kodu Barcode Code
NPU 65x42	65	5.50 mm	7,799	2003954
NPU 65x42D	65	5.50 mm	7,253	2003955
NPU 80x45	80	6.00 mm	9,504	2003990
NPU 80x45D	80	6.00 mm	8,838	2003991
NPU 100x50	100	6.00 mm	11,660	2003992
NPU 100x50D	100	6.00 mm	10,843	2003993

W = GENİŞLİK = WIDTH / T = KALINLIK = THICKNESS

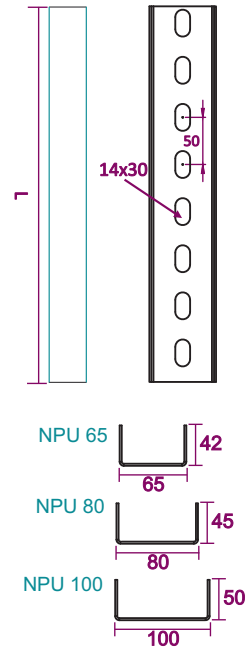

- * Farklı kalınlık ve ölçülerde üretim yapılabılır.
- * Malzeme ağırlıkları yaklaşık değerlerdir, \pm %10 değişiklik gösterebilir.
- * Malzeme kalınlık toleransı \pm %10 dur.
- * Lütfen siparişlerinizde sipariş kodu veya ürün kodu ve kaplama şeklini belirtiniz.

- * We can produce cable trays different thickness and dimensions
- * Cable trays are shown approximately weight, they could change \pm %10 difference.
- * Cable trays thickness tolerances are shown \pm %10 .
- * Please indicate order code and coating type in your orders.

DS SERIES

DESTEK SİSTEMİ

SUPPORT SYSTEM

PREGALVANİZ (PG)
PREGALVANIZED (PG)
TS EN 10346

SICAK DALDIRMA (SD)
HOT DIP GALVANIZED (HDG)
TS EN ISO 1461

21x41 C PROFİLLER / 21x41 C PROFILE



Sipariş Kodu Order Code	Ebat (mm) Size (mm)	L (mm)	T (mm)	Ağırlık (kg/mt) Weight (kg/mt)	Barkod Kodu Barcode Code
CPD 21x41-15	21x41	3.000	1.50 mm	1,073	2003700
CPD 21x41-20	21x41	3.000	2.00 mm	1,431	2003701
CP 21x41-15	21x41	3.000	1.50 mm	1,154	2003702
CP 21x41-20	21x41	3.000	2.00 mm	1,538	2003703

Sipariş Kodu Order Code	Ebat (mm) Size (mm)	L (mm)	T (mm)	Ağırlık (kg/mt) Weight (kg/mt)	Barkod Kodu Barcode Code
CPD 21x41-15	21x41	3.000	1.50 mm	1,180	2003700
CPD 21x41-20	21x41	3.000	2.00 mm	1,574	2003701
CP 21x41-15	21x41	3.000	1.50 mm	1,269	2003702
CP 21x41-20	21x41	3.000	2.00 mm	1,692	2003703
CPD 21x41-15B	21x82	3.000	1.50 mm	2,361	2003704
CPD 21x41-20B	21x82	3.000	2.00 mm	3,148	2003705
CP 21x41-15B	21x82	3.000	1.50 mm	2,539	2003706
CP 21x41-20B	21x82	3.000	2.00 mm	3,384	2003707

L = BOY = LENGTH / T = KALINLIK = THICKNESS

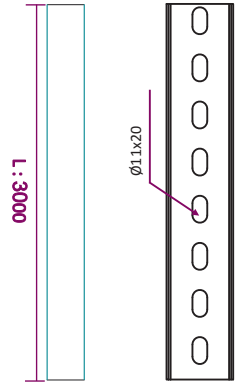
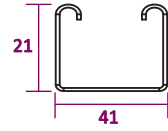

Standart uzunluk L:3000 mm
Toplu miktarlarda Özel ölçüler yapılabilir.
Standard Length L:3000 mm
Custom sizes can be made in bulk quantities.

26x41 C PROFİLLER / 26x41 C PROFILE



Sipariş Kodu Order Code	Ebat (mm) Size (mm)	L (mm)	T (mm)	Ağırlık (kg/mt) Weight (kg/mt)	Barkod Kodu Barcode Code
CPD 26x41-15	26x41	3.000	1.50 mm	1,169	2003708
CPD 26x41-20	26x41	3.000	2.00 mm	1,558	2003709
CP 26x41-15	26x41	3.000	1.50 mm	1,271	2003710
CP 26x41-20	26x41	3.000	2.00 mm	1,694	2003711

Sipariş Kodu Order Code	Ebat (mm) Size (mm)	L (mm)	T (mm)	Ağırlık (kg/mt) Weight (kg/mt)	Barkod Kodu Barcode Code
CPD 26x41-15	26x41	3.000	1.50 mm	1,286	2003708
CPD 26x41-20	26x41	3.000	2.00 mm	1,714	2003709
CP 26x41-15	26x41	3.000	1.50 mm	1,398	2003710
CP 26x41-20	26x41	3.000	2.00 mm	1,863	2003711

L = BOY = LENGTH / T = KALINLIK = THICKNESS

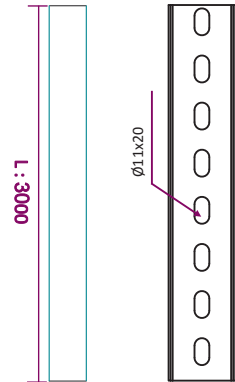
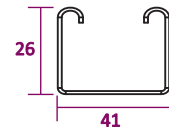

ARTIM METAL ELEKTRİK A.Ş.

* Farklı kalınlık ve ölçülerde üretim yapılabılır.
* Malzeme ağırlıkları yaklaşık değerlerdir, ± %10 değişiklik gösterebilir.
* Malzeme kalınlık toleransı ± %10 dur.
* Lütfen siparişlerinizde sipariş kodu veya ürün kodu ve Kaplama şeklini belirtiniz.

* We can produce cable trays different thickness and dimensions
* Cable trays are shown approximately weight, they could change ± %10 difference.
* Cable trays thickness tolerances are shown ± %10 .
* Please indicate order code and coating type in your orders.

DS SERIES

DESTEK SİSTEMİ

SUPPORT SYSTEM

PREGALVANİZ (PG)
PREGALVANIZED (PG)
TS EN 10346

SICAK DALDIRMA (SD)
HOT DIP GALVANIZED (HDG)
TS EN ISO 1461

41x41 C PROFİLLER / 41x41 C PROFILE



Sipariş Kodu Order Code	Ebat (mm) Size (mm)	L (mm)	T (mm)	Ağırlık (kg/mt) Weight (kg/mt)	Barkod Kodu Barcode Code
CPD 41x41-15	41x41	3.000	1.50 mm	1,511	2003700
CPD 41x41-20	41x41	3.000	2.00 mm	2,014	2003701
CP 41x41-15	41x41	3.000	1.50 mm	1,625	2003702
CP 41x41-20	41x41	3.000	2.00 mm	2,167	2003703

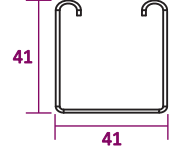

Sipariş Kodu Order Code	Ebat (mm) Size (mm)	L (mm)	T (mm)	Ağırlık (kg/mt) Weight (kg/mt)	Barkod Kodu Barcode Code
CPD 41x41-15	41x41	3.000	1.50 mm	1,662	2003700
CPD 41x41-20	41x41	3.000	2.00 mm	2,215	2003701
CP 41x41-15	41x41	3.000	1.50 mm	1,788	2003702
CP 41x41-20	41x41	3.000	2.00 mm	2,384	2003703
CPD 41x41-15B	41x82	3.000	1.50 mm	3,324	2003704
CPD 41x41-20B	41x82	3.000	2.00 mm	4,431	2003705
CP 41x41-15B	41x82	3.000	1.50 mm	3,575	2003706
CP 41x41-20B	41x82	3.000	2.00 mm	4,767	2003707

SD / HDG

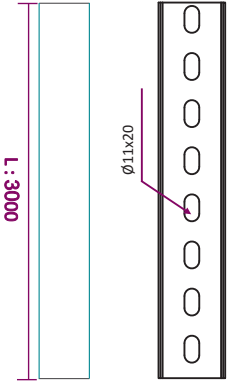

L = BOY = LENGTH / T = KALINLIK = THICKNESS

Standart uzunluk L:3000 mm
Toplu miktarlarda Özel ölçüler yapılabilir.
Standard Length L:3000 mm
Custom sizes can be made in bulk quantities.

18x32 C PROFİLLER / 18x32 C PROFILE



Sipariş Kodu Order Code	Ebat (mm) Size (mm)	L (mm)	T (mm)	Ağırlık (kg/mt) Weight (kg/mt)	Barkod Kodu Barcode Code
CPD 18x32-15	18x32	3.000	1.50 mm	0,812	2003712
CPD 18x32-20	18x32	3.000	2.00 mm	1,083	2003713
CP 18x32-15	18x32	3.000	1.50 mm	0,883	2003714
CP 18x32-20	18x32	3.000	2.00 mm	1,177	2003715

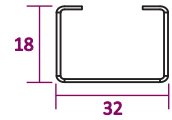

Sipariş Kodu Order Code	Ebat (mm) Size (mm)	L (mm)	T (mm)	Ağırlık (kg/mt) Weight (kg/mt)	Barkod Kodu Barcode Code
CPD 18x32-15	18x32	3.000	1.50 mm	0,893	2003712
CPD 18x32-20	18x32	3.000	2.00 mm	1,191	2003713
CP 18x32-15	18x32	3.000	1.50 mm	0,971	2003714
CP 18x32-20	18x32	3.000	2.00 mm	1,295	2003715

SD / HDG

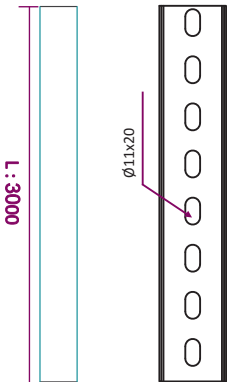

L = BOY = LENGTH / T = KALINLIK = THICKNESS

* Farklı kalınlık ve ölçülerde üretim yapılabılır.
* Malzeme ağırlıkları yaklaşık değerlerdir, ± %10 değişiklik gösterebilir.
* Malzeme kalınlık toleransı ± %10 dur.
* Lütfen siparişlerinizde sipariş kodu veya ürün kodu ve kaplama şeklini belirtiniz.

* We can produce cable trays different thickness and dimensions
* Cable trays are shown approximately weight, they could change ± %10 difference.
* Cable trays thickness tolerances are shown ± %10 .
* Please indicate order code and coating type in your orders.

DS SERIES

DESTEK SİSTEMİ

SUPPORT SYSTEM

PREGALVANİZ (PG)
PREGALVANIZED (PG)
TS EN 10346

SICAK DALDIRMA (SD)
HOT DIP GALVANIZED (HDG)
TS EN ISO 1461

C PROFİL KONSOLLARI / C SUPPORT BRACKETS



Sipariş Kodu Order Code	L (mm)	T (mm)	Ağırlık (kg/ad) Weight (kg/pcs)	Barkod Kodu Barcode Code
CPK 41x21-05	60	1.50 mm	0,339	2003720
CPK 41x21-10	110	1.50 mm	0,395	2003721
CPK 41x21-20	210	1.50 mm	0,507	2003722
CPK 41x21-30	310	1.50 mm	0,623	2003723
CPK 41x21-40	410	2.00 mm	0,888	2003724
CPK 41x21-50	510	2.00 mm	1,037	2003725
CPK 41x21-60	610	2.00 mm	1,186	2003726

PG

T = Kalınlık = Thickness = 4.00 mm

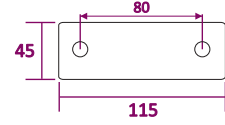

T = Kalınlık = Thickness = 1.50/2.00 mm

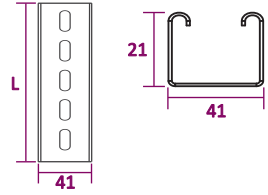

SD / HDG

Sipariş Kodu Order Code	L (mm)	T (mm)	Ağırlık (kg/ad) Weight (kg/pcs)	Barkod Kodu Barcode Code
CPK 41x21-05	60	1.50 mm	0,365	2003720
CPK 41x21-10	110	1.50 mm	0,425	2003721
CPK 41x21-20	210	1.50 mm	0,545	2003722
CPK 41x21-30	310	1.50 mm	0,670	2003723
CPK 41x21-40	410	2.00 mm	0,955	2003724
CPK 41x21-50	510	2.00 mm	1,115	2003725
CPK 41x21-60	610	2.00 mm	1,275	2003726

L = BOY = LENGTH / T = KALINLIK = THICKNESS

C PROFİL KONSOLLARI / C SUPPORT BRACKETS



Sipariş Kodu Order Code	L (mm)	T (mm)	Ağırlık (kg/ad) Weight (kg/pcs)	Barkod Kodu Barcode Code
CPKD 41x21-10	110	1.50 mm	0,560	2003727
CPKD 41x21-20	210	1.50 mm	0,800	2003728
CPKD 41x21-30	310	1.50 mm	1,045	2003729
CPKD 41x21-40	410	2.00 mm	1,615	2003730
CPKD 41x21-50	510	2.00 mm	1,935	2003731
CPKD 41x21-60	610	2.00 mm	2,260	2003732

SD / HDG

T = Kalınlık = Thickness = 4.00 mm

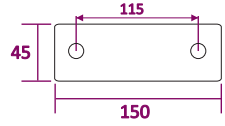

T = Kalınlık = Thickness = 1.50/2.00 mm

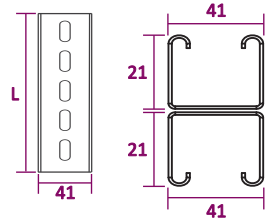

L = BOY = LENGTH / T = KALINLIK = THICKNESS

ARTIM METAL ELEKTRİK A.Ş.

* Farklı kalınlık ve ölçülerde üretim yapılabılır.
* Malzeme ağırlıkları yaklaşık değerlerdir, \pm %10 değişiklik gösterebilir.
* Malzeme kalınlık toleransı \pm %10 dur.
* Lütfen siparişlerinizde sipariş kodu veya ürün kodu ve kaplama şeklini belirtiniz.

* We can produce cable trays different thickness and dimensions
* Cable trays are shown approximately weight, they could change \pm %10 difference.
* Cable trays thickness tolerances are shown \pm %10 .
* Please indicate order code and coating type in your orders.

DS SERIES

DESTEK SİSTEMİ

SUPPORT SYSTEM

PREGALVANİZ (PG)
PREGALVANIZED (PG)
TS EN 10346

SICAK DALDIRMA (SD)
HOT DIP GALVANIZED (HDG)
TS EN ISO 1461

C PROFİL KONSOLLARI / C SUPPORT BRACKETS

Sipariş Kodu Order Code	L (mm)	T (mm)	Ağırlık (kg/ad) Weight (kg/pcs)	Barkod Kodu Barcode Code
CPK 41x41-10	110	2.00 mm	0,451	2003733
CPK 41x41-20	210	2.00 mm	0,609	2003734
CPK 41x41-30	310	2.00 mm	0,772	2003735
CPK 41x41-40	410	2.00 mm	1,153	2003736
CPK 41x41-50	510	2.00 mm	1,367	2003737
CPK 41x41-60	610	2.00 mm	1,581	2003738

PG

T = Kalınlık = Thickness = 4.00 mm

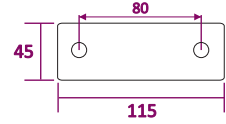

T = Kalınlık = Thickness = 1.50/2.00 mm

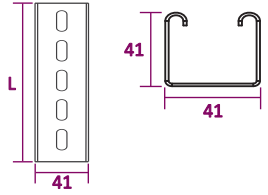

SD / HDG

Sipariş Kodu Order Code	L (mm)	T (mm)	Ağırlık (kg/ad) Weight (kg/pcs)	Barkod Kodu Barcode Code
CPK 41x41-10	110	2.00 mm	0,485	2003733
CPK 41x41-20	210	2.00 mm	0,655	2003734
CPK 41x41-30	310	2.00 mm	0,830	2003735
CPK 41x41-40	410	2.00 mm	1,240	2003736
CPK 41x41-50	510	2.00 mm	1,470	2003737
CPK 41x41-60	610	2.00 mm	1,700	2003738

L = BOY = LENGTH / T = KALINLIK = THICKNESS

C PROFİL KONSOLLARI / C SUPPORT BRACKETS

Sipariş Kodu Order Code	L (mm)	T (mm)	Ağırlık (kg/ad) Weight (kg/pcs)	Barkod Kodu Barcode Code
CPKD 41x41-30	310	2.00 mm	1,313	2003739
CPKD 41x41-40	410	2.00 mm	1,982	2003740
CPKD 41x41-50	510	2.00 mm	2,651	2003741
CPKD 41x41-60	610	2.00 mm	3,121	2003742

SD / HDG

T = Kalınlık = Thickness = 4.00 mm

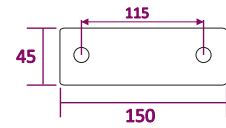

T = Kalınlık = Thickness = 1.50/2.00 mm

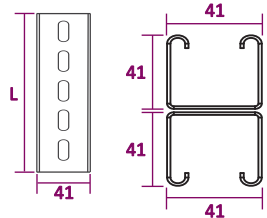

L = BOY = LENGTH / T = KALINLIK = THICKNESS

* Farklı kalınlık ve ölçülerde üretim yapılabılır.
* Malzeme ağırlıkları yaklaşık değerlerdir, ± %10 değişiklik gösterebilir.
* Malzeme kalınlık toleransı ± %10 dur.
* Lütfen siparişlerinizde sipariş kodu veya ürün kodu ve kaplama şeklini belirtiniz.

* We can produce cable trays different thickness and dimensions
* Cable trays are shown approximately weight, they could change ± %10 difference.
* Cable trays thickness tolerances are shown ± %10 .
* Please indicate order code and coating type in your orders.

DS SERIES

DESTEK SİSTEMİ

SUPPORT SYSTEM

SICAK DALDIRMA (SD)
HOT DIP GALVANIZED (HDG)
TS EN ISO 1461



C PROFİL TAVAN VE TABAN DESTEKLERİ / C HANGING SUPPORT SYSTEMS

Sipariş Kodu Order Code	L (mm)	T (mm)	Ağırlık (kg/ad) Weight (kg/pcs)	Barkod Kodu Barcode Code	SD / HDG
CP 2x21 -050-15	500	1.50 mm	0,905	2003800	
CP 2x21 -050-20	500	2.00 mm	1,100	2003801	
CP 2x21 -100-15	1.000	1.50 mm	1,515	2003802	
CP 2x21 -100-20	1.000	2.00 mm	1,905	2003803	
CP 2x21 -150-15	1.500	1.50 mm	2,125	2003804	
CP 2x21 -150-20	1.500	2.00 mm	2,710	2003805	
CP 2x21 -200-15	2.000	1.50 mm	2,735	2003806	
CP 2x21 -200-20	2.000	2.00 mm	3,515	2003807	
CP 2x21 -250-15	2.500	1.50 mm	3,345	2003808	
CP 2x21 -250-20	2.500	2.00 mm	4,320	2003809	
CP 2x21 -300-15	3.000	1.50 mm	3,955	2003810	
CP 2x21 -300-20	3.000	2.00 mm	5,130	2003811	

L = BOY = LENGTH / T = KALINLIK = THICKNESS

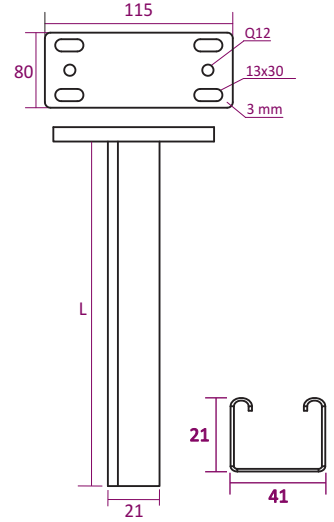

C PROFİL TAVAN VE TABAN DESTEKLERİ / C HANGING SUPPORT SYSTEMS

Sipariş Kodu Order Code	L (mm)	T (mm)	Ağırlık (kg/ad) Weight (kg/pcs)	Barkod Kodu Barcode Code	SD / HDG
CP 2xD21 -050-15	500	1.50 mm	1,515	2003812	
CP 2xD21 -050-20	500	2.00 mm	1,905	2003813	
CP 2xD21 -100-15	1.000	1.50 mm	2,735	2003814	
CP 2xD21 -100-20	1.000	2.00 mm	3,515	2003815	
CP 2xD21 -150-15	1.500	1.50 mm	3,955	2003816	
CP 2xD21 -150-20	1.500	2.00 mm	5,125	2003817	
CP 2xD21 -200-15	2.000	1.50 mm	5,175	2003818	
CP 2xD21 -200-20	2.000	2.00 mm	6,735	2003819	
CP 2xD21 -250-15	2.500	1.50 mm	6,395	2003820	
CP 2xD21 -250-20	2.500	2.00 mm	8,345	2003821	
CP 2xD21 -300-15	3.000	1.50 mm	7,260	2003822	
CP 2xD21 -300-20	3.000	2.00 mm	9,955	2003823	

L = BOY = LENGTH / T = KALINLIK = THICKNESS

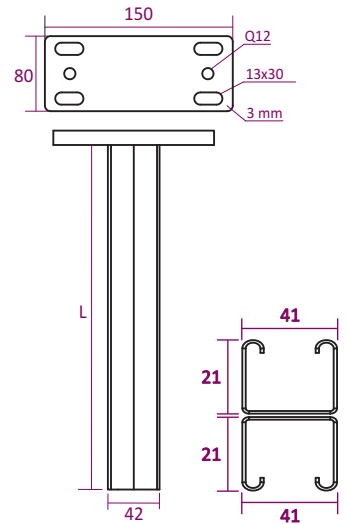

ARTIM METAL ELEKTRİK A.Ş.

* Farklı kalınlık ve ölçülerde üretim yapılabılır.
* Malzeme ağırlıkları yaklaşık değerlerdir, \pm %10 değişiklik gösterebilir.
* Malzeme kalınlık toleransı \pm %10 dur.
* Lütfen siparişlerinizde sipariş kodu veya ürün kodu ve Kaplama şeklini belirtiniz.

* We can produce cable trays different thickness and dimensions
* Cable trays are shown approximately weight, they could change \pm %10 difference.
* Cable trays thickness tolerances are shown \pm %10 .
* Please indicate order code and coating type in your orders.

DS SERIES

DESTEK SİSTEMİ

SUPPORT SYSTEM

SICAK DALDIRMA (SD)

HOT DIP GALVANIZED (HDG)

TS EN ISO 1461

C PROFİL TAVAN VE TABAN DESTEKLERİ / C HANGING SUPPORT SYSTEMS



Sipariş Kodu Order Code	L (mm)	T (mm)	Ağırlık (kg/ad) Weight (kg/pcs)	SD / HDG	Barkod Kodu Barcode Code
CP 2x41 -050-15	500	1.50 mm	1,084		2003824
CP 2x41 -050-20	500	2.00 mm	1,445		2003825
CP 2x41 -100-15	1.000	1.50 mm	1,946		2003826
CP 2x41 -100-20	1.000	2.00 mm	2,595		2003827
CP 2x41 -150-15	1.500	1.50 mm	2,812		2003828
CP 2x41 -150-20	1.500	2.00 mm	3,750		2003829
CP 2x41 -200-15	2.000	1.50 mm	3,675		2003830
CP 2x41 -200-20	2.000	2.00 mm	4,900		2003831
CP 2x41 -250-15	2.500	1.50 mm	4,537		2003832
CP 2x41 -250-20	2.500	2.00 mm	6,050		2003833
CP 2x41 -300-15	3.000	1.50 mm	5,400		2003834
CP 2x41 -300-20	3.000	2.00 mm	7,200		2003835

L = BOY = LENGTH / T = KALINLIK = THICKNESS

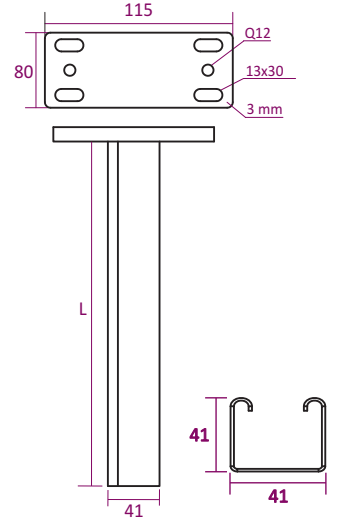

C PROFİL TAVAN VE TABAN DESTEKLERİ / C HANGING SUPPORT SYSTEMS

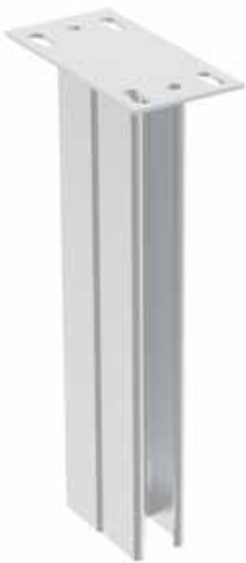

Sipariş Kodu Order Code	L (mm)	T (mm)	Ağırlık (kg/ad) Weight (kg/pcs)	SD / HDG	Barkod Kodu Barcode Code
CP 2xD41 -050-15	500	1.50 mm	1,946		2003836
CP 2xD41 -050-20	500	2.00 mm	2,595		2003837
CP 2xD41 -100-15	1.000	1.50 mm	3,675		2003838
CP 2xD41 -100-20	1.000	2.00 mm	4,900		2003839
CP 2xD41 -150-15	1.500	1.50 mm	5,400		2003840
CP 2xD41 -150-20	1.500	2.00 mm	7,200		2003841
CP 2xD41 -200-15	2.000	1.50 mm	7,128		2003842
CP 2xD41 -200-20	2.000	2.00 mm	9,505		2003843
CP 2xD41 -250-15	2.500	1.50 mm	8,857		2003844
CP 2xD41 -250-20	2.500	2.00 mm	11,810		2003845
CP 2xD41 -300-15	3.000	1.50 mm	10,585		2003846
CP 2xD41 -300-20	3.000	2.00 mm	14,110		2003847

L = BOY = LENGTH / T = KALINLIK = THICKNESS

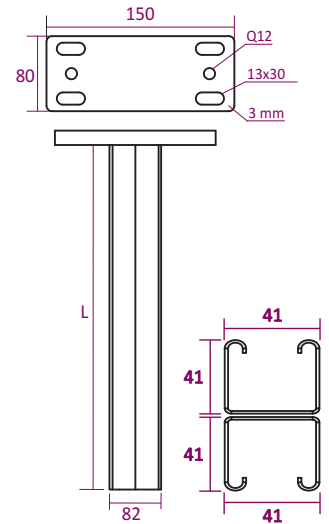

* Farklı kalınlık ve ölçülerde üretim yapılabılır.
* Malzeme ağırlıkları yaklaşık değerlerdir, ± %10 değişiklik gösterebilir.
* Malzeme kalınlık toleransı ± %10 dur.
* Lütfen siparişlerinizde sipariş kodu veya ürün kodu ve Kaplama şeklini belirtiniz.

* We can produce cable trays different thickness and dimensions
* Cable trays are shown approximately weight, they could change ± %10 difference.
* Cable trays thickness tolerances are shown ± %10 .
* Please indicate order code and coating type in your orders.

DS SERIES

DESTEK SİSTEMİ

SUPPORT SYSTEM

SICAK DALDIRMA (SD)

HOT DIP GALVANIZED (HDG)

TS EN ISO 1461

C PROFİL TAVAN VE TABAN DESTEKLERİ / C HANGING SUPPORT SYSTEMS



Sipariş Kodu Order Code	L (mm)	T (mm)	Ağırlık (kg/ad) Weight (kg/pcs)	Barkod Kodu Barcode Code
CPT-1	120	2.00 mm	0,445	2003748

L = BOY = LENGTH / T = KALINLIK = THICKNESS

SD / HDG

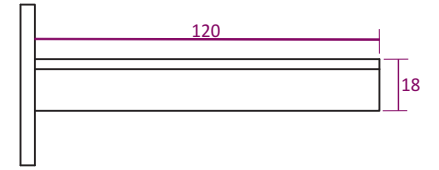
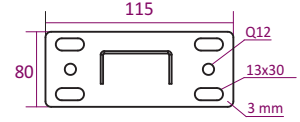

C PROFİL TAVAN VE TABAN DESTEKLERİ / C HANGING SUPPORT SYSTEMS



Sipariş Kodu Order Code	L (mm)	T (mm)	Ağırlık (kg/ad) Weight (kg/pcs)	Barkod Kodu Barcode Code
CPT-2	120	2.00 mm	0,515	2003749

L = BOY = LENGTH / T = KALINLIK = THICKNESS

SD / HDG

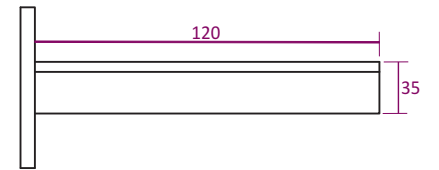
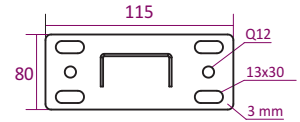

ARTIM METAL ELEKTRİK A.Ş.

- * Farklı kalınlık ve ölçülerde üretim yapılabılır.
- * Malzeme ağırlıkları yaklaşık değerlerdir, \pm %10 değişiklik gösterebilir.
- * Malzeme kalınlık toleransı \pm %10 dur.
- * Lütfen siparişlerinizde sipariş kodu veya ürün kodu ve kaplama şeklini belirtiniz.

- * We can produce cable trays different thickness and dimensions
- * Cable trays are shown approximately weight, they could change \pm %10 difference.
- * Cable trays thickness tolerances are shown \pm %10 .
- * Please indicate order code and coating type in your orders.

DS SERIES

DESTEK SİSTEMİ

SUPPORT SYSTEM

SICAK DALDIRMA (SD)

HOT DIP GALVANIZED (HDG)

TS EN ISO 1461

C PROFİL TAVAN VE TABAN DESTEKLERİ / C HANGING SUPPORT SYSTEMS



	SD / HDG			
Sipariş Kodu	L	T	Ağırlık (kg/ad)	Barkod Kodu
Order Code	(mm)	(mm)	Weight (kg/pcs)	Barcode Code
CPT-3	120	2.00 mm	0,565	2003750

L = BOY = LENGTH / T = KALINLIK = THICKNESS

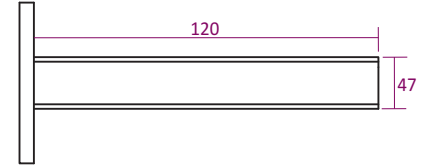
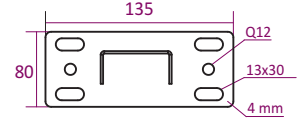

C PROFİL TAVAN VE TABAN DESTEKLERİ / C HANGING SUPPORT SYSTEMS



	SD / HDG			
Sipariş Kodu	L	T	Ağırlık (kg/ad)	Barkod Kodu
Order Code	(mm)	(mm)	Weight (kg/pcs)	Barcode Code
CPT-4	120	2.00 mm	1,110	2003751

L = BOY = LENGTH / T = KALINLIK = THICKNESS

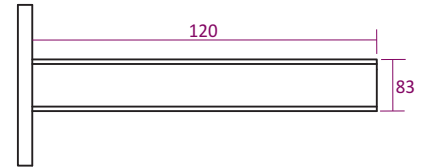
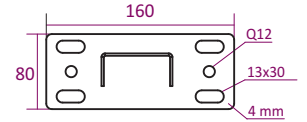

* Farklı kalınlık ve ölçülerde üretim yapıla bilinir.
* Malzeme ağırlıkları yaklaşık değerlerdir, ± %10 değişiklik gösterebilir.
* Malzeme kalınlık toleransı ± %10 dur.
* Lütfen siparişlerinizde sipariş kodu veya ürün kodu ve Kaplama şeklini belirtiniz.

* We can produce cable trays different thickness and dimensions
* Cable trays are shown approximately weight, they could change ± %10 difference.
* Cable trays thickness tolerances are shown ± %10 .
* Please indicate order code and coating type in your orders.

DS SERIES

DESTEK SİSTEMİ

SUPPORT SYSTEM

PREGALVANİZ (PG)
PREGALVANIZED (PG)
TS EN 10346

SICAK DALDIRMA (SD)
HOT DIP GALVANIZED (HDG)
TS EN ISO 1461

C DESTEK BAĞLANTI ELEMANLARI / C SUPPORT CONNECTION ITEMS

PG

Sipariş Kodu Order Code	T (mm)	Ağırlık (kg/ad) Weight (kg/pcs)	Barkod Kodu Barcode Code
CB-1	5.00 mm	0,338	2003760

SD / HDG

Sipariş Kodu Order Code	T (mm)	Ağırlık (kg/ad) Weight (kg/pcs)	Barkod Kodu Barcode Code
CB-1	5.00 mm	0,350	2003760

T = KALINLIK = THICKNESS

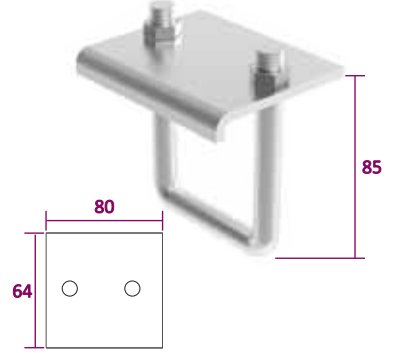

C DESTEK BAĞLANTI ELEMANLARI / C SUPPORT CONNECTION ITEMS

PG

Sipariş Kodu Order Code	T (mm)	Ağırlık (kg/ad) Weight (kg/pcs)	Barkod Kodu Barcode Code
CB-2	5.00 mm	0,376	2003761

SD / HDG

Sipariş Kodu Order Code	T (mm)	Ağırlık (kg/ad) Weight (kg/pcs)	Barkod Kodu Barcode Code
CB-2	5.00 mm	0,390	2003761

T = KALINLIK = THICKNESS

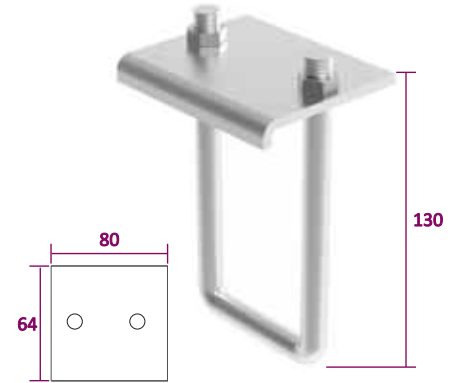

C DESTEK BAĞLANTI ELEMANLARI / C SUPPORT CONNECTION ITEMS

PG

Sipariş Kodu Order Code	T (mm)	Ağırlık (kg/ad) Weight (kg/pcs)	Barkod Kodu Barcode Code
CB-3	2.00 mm	0,610	2003762

SD / HDG

Sipariş Kodu Order Code	T (mm)	Ağırlık (kg/ad) Weight (kg/pcs)	Barkod Kodu Barcode Code
CB-3	2.00 mm	0,644	2003762

T = KALINLIK = THICKNESS

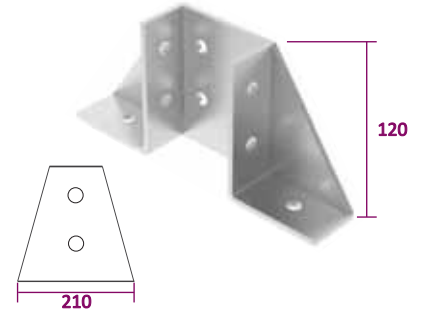

ARTIM METAL ELEKTRİK A.Ş.

* Farklı kalınlık ve ölçülerde üretim yapılabılır.
* Malzeme ağırlıkları yaklaşık değerlerdir, \pm %10 değişiklik gösterebilir.
* Malzeme kalınlık toleransı \pm %10 dur.
* Lütfen siparişlerinizde sipariş kodu veya ürün kodu ve Kaplama şeklini belirtiniz.

* We can produce cable trays different thickness and dimensions
* Cable trays are shown approximately weight, they could change \pm %10 difference.
* Cable trays thickness tolerances are shown \pm %10 .
* Please indicate order code and coating type in your orders.

DS SERIES

DESTEK SİSTEMİ

SUPPORT SYSTEM

PREGALVANİZ (PG)
PREGALVANIZED (PG)
TS EN 10346

SICAK DALDIRMA (SD)
HOT DIP GALVANIZED (HDG)
TS EN ISO 1461

C DESTEK BAĞLANTI ELEMANLARI / C SUPPORT CONNECTION ITEMS



Sipariş Kodu Order Code	T (mm)	Ağırlık (kg/ad) Weight (kg/pcs)	Barkod Kodu Barcode Code
CB-4	2.00 mm	0,588	2003763

PG

Sipariş Kodu Order Code	T (mm)	Ağırlık (kg/ad) Weight (kg/pcs)	Barkod Kodu Barcode Code
CB-4	2.00 mm	0,617	2003763

SD / HDG

T = KALINLIK = THICKNESS

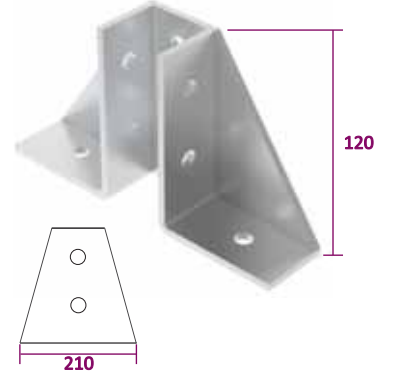

C DESTEK BAĞLANTI ELEMANLARI / C SUPPORT CONNECTION ITEMS

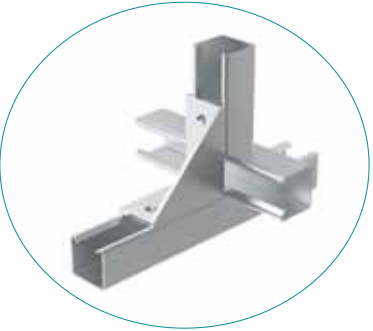

Sipariş Kodu Order Code	T (mm)	Ağırlık (kg/ad) Weight (kg/pcs)	Barkod Kodu Barcode Code
CB-5	2.00 mm	0,172	2003765

PG

Sipariş Kodu Order Code	T (mm)	Ağırlık (kg/ad) Weight (kg/pcs)	Barkod Kodu Barcode Code
CB-5	2.00 mm	0,182	2003765

SD / HDG

T = KALINLIK = THICKNESS

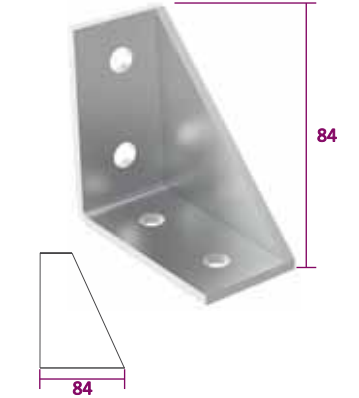

C DESTEK BAĞLANTI ELEMANLARI / C SUPPORT CONNECTION ITEMS

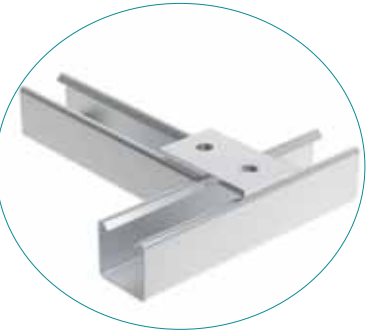

Sipariş Kodu Order Code	T (mm)	Ağırlık (kg/ad) Weight (kg/pcs)	Barkod Kodu Barcode Code
CB-6	5.00 mm	0,130	2003766

PG

Sipariş Kodu Order Code	T (mm)	Ağırlık (kg/ad) Weight (kg/pcs)	Barkod Kodu Barcode Code
CB-6	5.00 mm	0,134	2003766

SD / HDG

T = KALINLIK = THICKNESS

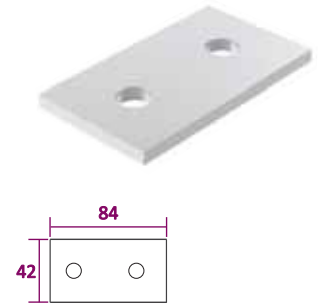

* Farklı kalınlık ve ölçülerde üretim yapıla bilinir.
* Malzeme ağırlıkları yaklaşık değerlerdir, \pm %10 değişiklik gösterebilir.
* Malzeme kalınlık toleransı \pm %10 dur.
* Lütfen siparişlerinizde sipariş kodu veya ürün kodu ve Kaplama şeklini belirtiniz.

* We can produce cable trays different thickness and dimensions
* Cable trays are shown approximately weight, they could change \pm %10 difference.
* Cable trays thickness tolerances are shown \pm %10 .
* Please indicate order code and coating type in your orders.

DS SERIES

DESTEK SİSTEMİ

SUPPORT SYSTEM

PREGALVANİZ (PG)
PREGALVANIZED (PG)
TS EN 10346

SICAK DALDIRMA (SD)
HOT DIP GALVANIZED (HDG)
TS EN ISO 1461

C DESTEK BAĞLANTI ELEMANLARI / C SUPPORT CONNECTION ITEMS

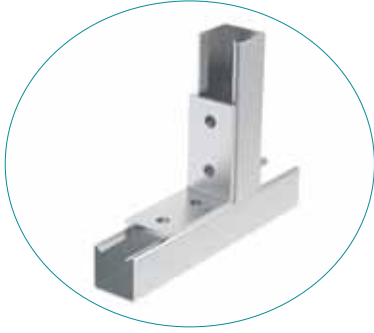

Sipariş Kodu Order Code	T (mm)	Ağırlık (kg/ad) Weight (kg/pcs)	Barkod Kodu Barcode Code
CB-7	5.00 mm	0,292	2003767

PG

Sipariş Kodu Order Code	T (mm)	Ağırlık (kg/ad) Weight (kg/pcs)	Barkod Kodu Barcode Code
CB-7	5.00 mm	0,299	2003767

SD / HDG

T = KALINLIK = THICKNESS

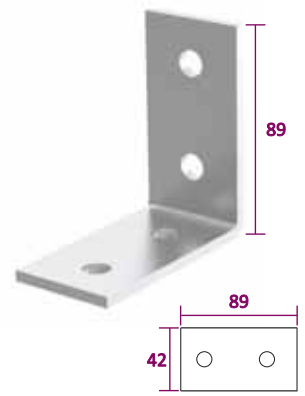

C DESTEK BAĞLANTI ELEMANLARI / C SUPPORT CONNECTION ITEMS

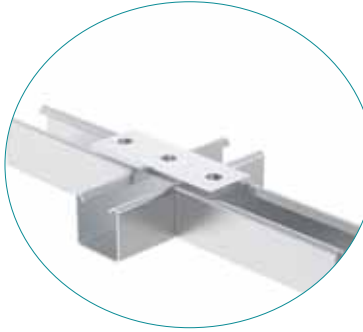

Sipariş Kodu Order Code	T (mm)	Ağırlık (kg/ad) Weight (kg/pcs)	Barkod Kodu Barcode Code
CB-8	5.00 mm	0,194	2003768

PG

Sipariş Kodu Order Code	T (mm)	Ağırlık (kg/ad) Weight (kg/pcs)	Barkod Kodu Barcode Code
CB-8	5.00 mm	0,199	2003768

SD / HDG

T = KALINLIK = THICKNESS

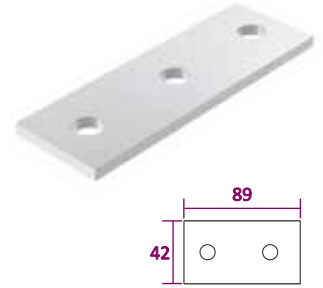

C DESTEK BAĞLANTI ELEMANLARI / C SUPPORT CONNECTION ITEMS

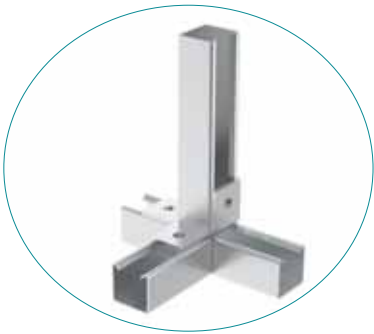

Sipariş Kodu Order Code	T (mm)	Ağırlık (kg/ad) Weight (kg/pcs)	Barkod Kodu Barcode Code
CB-9	5.00 mm	0,286	2003769

PG

Sipariş Kodu Order Code	T (mm)	Ağırlık (kg/ad) Weight (kg/pcs)	Barkod Kodu Barcode Code
CB-9	5.00 mm	0,293	2003769

SD / HDG

T = KALINLIK = THICKNESS

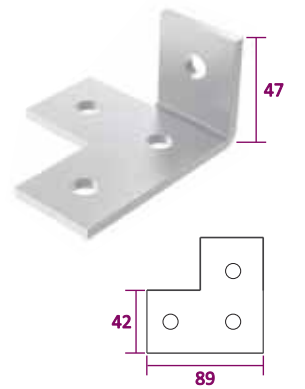

ARTIM METAL ELEKTRİK A.Ş.

- * Farklı kalınlık ve ölçülerde üretim yapılabılır.
- * Malzeme ağırlıkları yaklaşık değerlerdir, \pm %10 değişiklik gösterebilir.
- * Malzeme kalınlık toleransı \pm %10 dur.
- * Lütfen siparişlerinizde sipariş kodu veya ürün kodu ve Kaplama şeklini belirtiniz.

- * We can produce cable trays different thickness and dimensions
- * Cable trays are shown approximately weight, they could change \pm %10 difference.
- * Cable trays thickness tolerances are shown \pm %10 .
- * Please indicate order code and coating type in your orders.

DS SERIES

DESTEK SİSTEMİ

SUPPORT SYSTEM

PREGALVANİZ (PG)
PREGALVANIZED (PG)
TS EN 10346

SICAK DALDIRMA (SD)
HOT DIP GALVANIZED (HDG)
TS EN ISO 1461

C DESTEK BAĞLANTI ELEMANLARI / C SUPPORT CONNECTION ITEMS

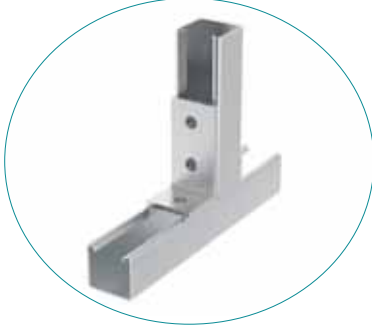

Sipariş Kodu Order Code	T (mm)	Ağırlık (kg/ad) Weight (kg/pcs)	Barkod Kodu Barcode Code
CB-10	5.00 mm	0,231	2003770

Sipariş Kodu Order Code	T (mm)	Ağırlık (kg/ad) Weight (kg/pcs)	Barkod Kodu Barcode Code
CB-10	5.00 mm	0,237	2003770

T = KALINLIK = THICKNESS

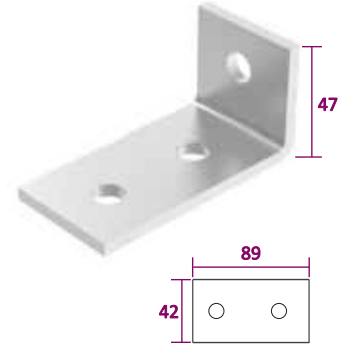

C DESTEK BAĞLANTI ELEMANLARI / C SUPPORT CONNECTION ITEMS

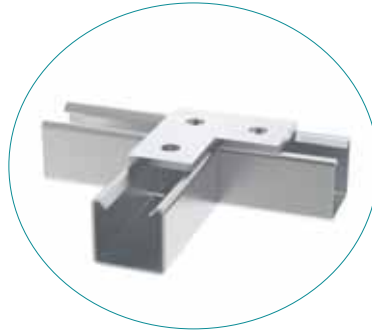

Sipariş Kodu Order Code	T (mm)	Ağırlık (kg/ad) Weight (kg/pcs)	Barkod Kodu Barcode Code
CB-11	5.00 mm	0,195	20037771

Sipariş Kodu Order Code	T (mm)	Ağırlık (kg/ad) Weight (kg/pcs)	Barkod Kodu Barcode Code
CB-11	5.00 mm	0,200	20037771

T = KALINLIK = THICKNESS

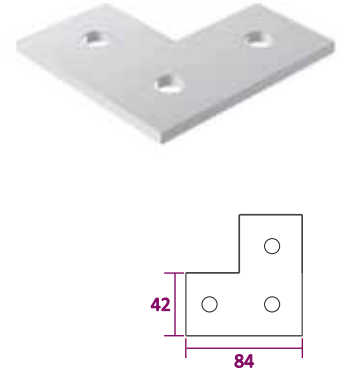

C DESTEK BAĞLANTI ELEMANLARI / C SUPPORT CONNECTION ITEMS

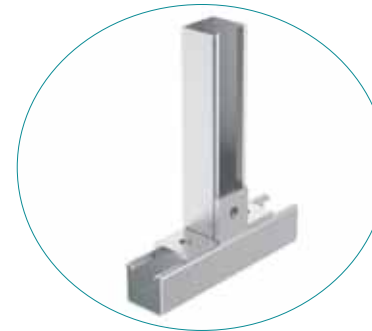

Sipariş Kodu Order Code	T (mm)	Ağırlık (kg/ad) Weight (kg/pcs)	Barkod Kodu Barcode Code
CB-12	5.00 mm	0,269	2003772

Sipariş Kodu Order Code	T (mm)	Ağırlık (kg/ad) Weight (kg/pcs)	Barkod Kodu Barcode Code
CB-12	5.00 mm	0,276	2003772

T = KALINLIK = THICKNESS

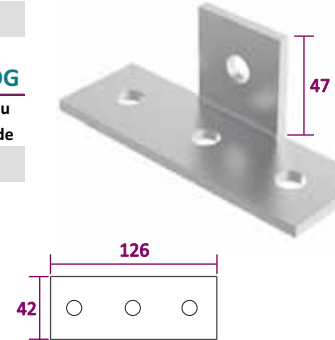

* Farklı kalınlık ve ölçülerde üretim yapılabılır.
* Malzeme ağırlıkları yaklaşık değerlerdir, \pm %10 değişiklik gösterebilir.
* Malzeme kalınlık toleransı \pm %10 dur.
* Lütfen siparişlerinizde sipariş kodu veya ürün kodu ve kaplama şeklini belirtiniz.

* We can produce cable trays different thickness and dimensions
* Cable trays are shown approximately weight, they could change \pm %10 difference.
* Cable trays thickness tolerances are shown \pm %10 .
* Please indicate order code and coating type in your orders.

DS SERIES

DESTEK SİSTEMİ

SUPPORT SYSTEM

PREGALVANİZ (PG)
PREGALVANIZED (PG)
TS EN 10346

SICAK DALDIRMA (SD)
HOT DIP GALVANIZED (HDG)
TS EN ISO 1461

C DESTEK BAĞLANTI ELEMANLARI / C SUPPORT CONNECTION ITEMS

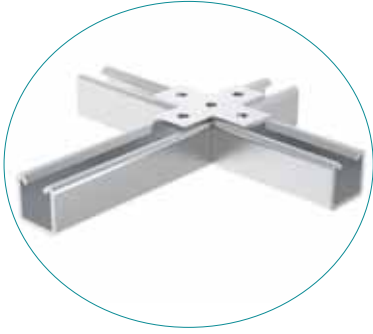

Sipariş Kodu Order Code	T (mm)	Ağırlık (kg/ad) Weight (kg/pcs)	Barkod Kodu Barcode Code
CB-13	5.00 mm	0,325	2003773

PG

Sipariş Kodu Order Code	T (mm)	Ağırlık (kg/ad) Weight (kg/pcs)	Barkod Kodu Barcode Code
CB-13	5.00 mm	0,334	2003773

SD / HDG

T = KALINLIK = THICKNESS

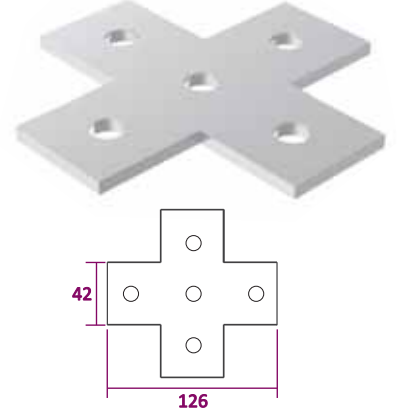

C DESTEK BAĞLANTI ELEMANLARI / C SUPPORT CONNECTION ITEMS

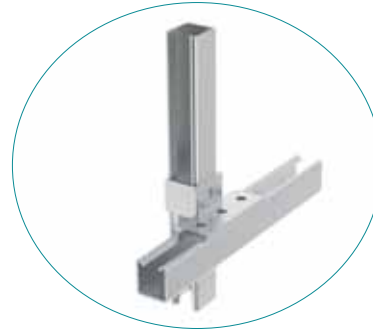

Sipariş Kodu Order Code	T (mm)	Ağırlık (kg/ad) Weight (kg/pcs)	Barkod Kodu Barcode Code
CB-14	5.00 mm	0,442	2003774

PG

Sipariş Kodu Order Code	T (mm)	Ağırlık (kg/ad) Weight (kg/pcs)	Barkod Kodu Barcode Code
CB-14	5.00 mm	0,453	2003774

SD / HDG

T = KALINLIK = THICKNESS

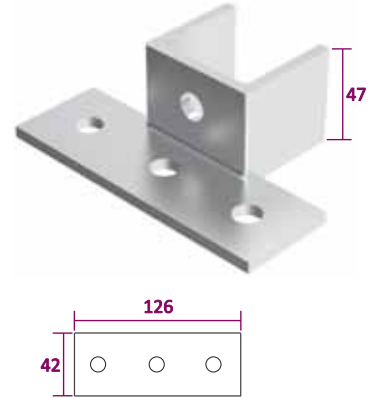

C DESTEK BAĞLANTI ELEMANLARI / C SUPPORT CONNECTION ITEMS

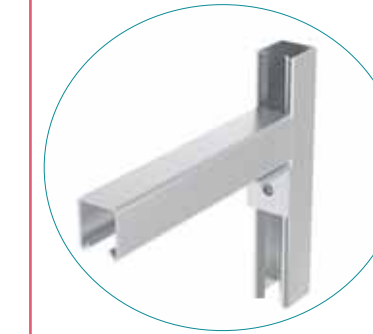

Sipariş Kodu Order Code	T (mm)	Ağırlık (kg/ad) Weight (kg/pcs)	Barkod Kodu Barcode Code
CB-15	5.00 mm	0,156	2003775

PG

Sipariş Kodu Order Code	T (mm)	Ağırlık (kg/ad) Weight (kg/pcs)	Barkod Kodu Barcode Code
CB-15	5.00 mm	0,160	2003775

SD / HDG

T = KALINLIK = THICKNESS

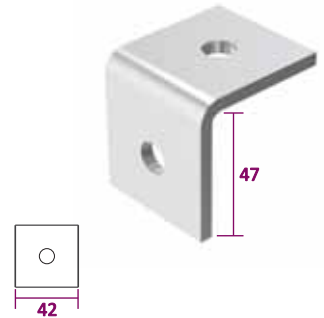

ARTIM METAL ELEKTRİK A.Ş.

* Farklı kalınlık ve ölçülerde üretim yapılabılır.
* Malzeme ağırlıkları yaklaşık değerlerdir, \pm %10 değişiklik gösterebilir.
* Malzeme kalınlık toleransı \pm %10 dur.
* Lütfen siparişlerinizde sipariş kodu veya ürün kodu ve Kaplama şeklini belirtiniz.

* We can produce cable trays different thickness and dimensions
* Cable trays are shown approximately weight, they could change \pm %10 difference.
* Cable trays thickness tolerances are shown \pm %10 .
* Please indicate order code and coating type in your orders.

DS SERIES

DESTEK SİSTEMİ

SUPPORT SYSTEM

PREGALVANİZ (PG)
PREGALVANIZED (PG)
TS EN 10346

SICAK DALDIRMA (SD)
HOT DIP GALVANIZED (HDG)
TS EN ISO 1461

C DESTEK BAĞLANTI ELEMANLARI / C SUPPORT CONNECTION ITEMS

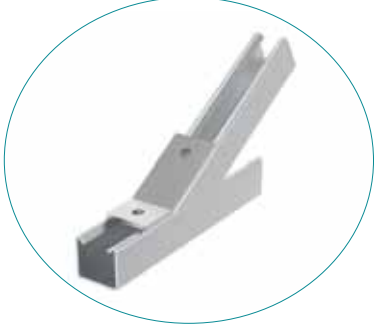

Sipariş Kodu Order Code	T (mm)	Ağırlık (kg/ad) Weight (kg/pcs)	Barkod Kodu Barcode Code
CB-16	5.00 mm	0,206	2003776

Sipariş Kodu Order Code	T (mm)	Ağırlık (kg/ad) Weight (kg/pcs)	Barkod Kodu Barcode Code
CB-16	5.00 mm	0,211	2003776

T = KALINLIK = THICKNESS

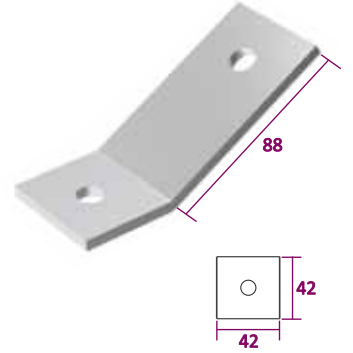

C DESTEK BAĞLANTI ELEMANLARI / C SUPPORT CONNECTION ITEMS

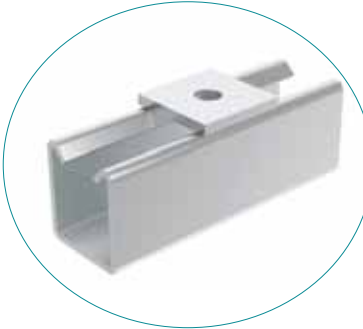

Sipariş Kodu Order Code	T (mm)	Ağırlık (kg/ad) Weight (kg/pcs)	Barkod Kodu Barcode Code
CB-17	5.00 mm	0,065	2003777

Sipariş Kodu Order Code	T (mm)	Ağırlık (kg/ad) Weight (kg/pcs)	Barkod Kodu Barcode Code
CB-17	5.00 mm	0,067	2003777

T = KALINLIK = THICKNESS

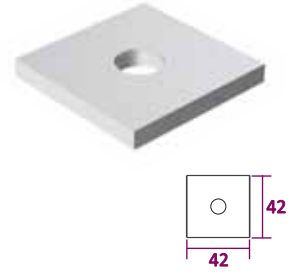

C DESTEK BAĞLANTI ELEMANLARI / C SUPPORT CONNECTION ITEMS

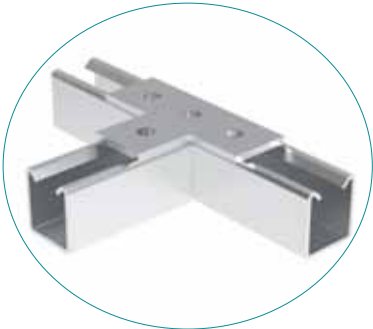

Sipariş Kodu Order Code	T (mm)	Ağırlık (kg/ad) Weight (kg/pcs)	Barkod Kodu Barcode Code
CB-18	5.00 mm	0,260	2003778

Sipariş Kodu Order Code	T (mm)	Ağırlık (kg/ad) Weight (kg/pcs)	Barkod Kodu Barcode Code
CB-18	5.00 mm	0,267	2003778

T = KALINLIK = THICKNESS

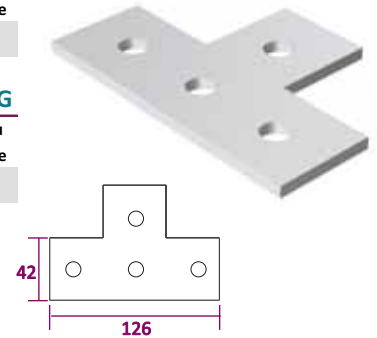

* Farklı kalınlık ve ölçülerde üretim yapılabılır.
* Malzeme ağırlıkları yaklaşık değerlerdir, \pm %10 değişiklik gösterebilir.
* Malzeme kalınlık toleransı \pm %10 dur.
* Lütfen siparişlerinizde sipariş kodu veya ürün kodu ve kaplama şeklini belirtiniz.

* We can produce cable trays different thickness and dimensions
* Cable trays are shown approximately weight, they could change \pm %10 difference.
* Cable trays thickness tolerances are shown \pm %10 .
* Please indicate order code and coating type in your orders.

DS SERIES

DESTEK SİSTEMİ

SUPPORT SYSTEM

PREGALVANİZ (PG)
PREGALVANIZED (PG)
TS EN 10346

SICAK DALDIRMA (SD)
HOT DIP GALVANIZED (HDG)
TS EN ISO 1461

C DESTEK BAĞLANTI ELEMANLARI / C SUPPORT CONNECTION ITEMS

PG

Sipariş Kodu Order Code	T (mm)	Ağırlık (kg/ad) Weight (kg/pcs)	Barkod Kodu Barcode Code
CB-19	5.00 mm	0,260	20037779

SD / HDG

Sipariş Kodu Order Code	T (mm)	Ağırlık (kg/ad) Weight (kg/pcs)	Barkod Kodu Barcode Code
CB-19	5.00 mm	0,267	20037779

T = KALINLIK = THICKNESS

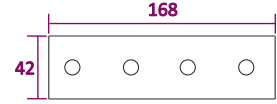

C DESTEK BAĞLANTI ELEMANLARI / C SUPPORT CONNECTION ITEMS

PG

Sipariş Kodu Order Code	T (mm)	Ağırlık (kg/ad) Weight (kg/pcs)	Barkod Kodu Barcode Code
CB-20	5.00 mm	0,322	2003780

SD / HDG

Sipariş Kodu Order Code	T (mm)	Ağırlık (kg/ad) Weight (kg/pcs)	Barkod Kodu Barcode Code
CB-20	5.00 mm	0,331	2003780

T = KALINLIK = THICKNESS

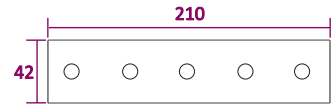

C DESTEK BAĞLANTI ELEMANLARI / C SUPPORT CONNECTION ITEMS

PG

Sipariş Kodu Order Code	T (mm)	Ağırlık (kg/ad) Weight (kg/pcs)	Barkod Kodu Barcode Code
CB-21	5.00 mm	0,744	2003781

SD / HDG

Sipariş Kodu Order Code	T (mm)	Ağırlık (kg/ad) Weight (kg/pcs)	Barkod Kodu Barcode Code
CB-21	5.00 mm	0,761	2003781

T = KALINLIK = THICKNESS

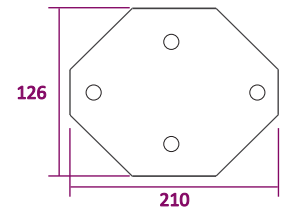

ARTIM METAL ELEKTRİK A.Ş.

- * Farklı kalınlık ve ölçülerde üretim yapılabılır.
- * Malzeme ağırlıkları yaklaşık değerlerdir, \pm %10 değişiklik gösterebilir.
- * Malzeme kalınlık toleransı \pm %10 dur.
- * Lütfen siparişlerinizde sipariş kodu veya ürün kodu ve Kaplama şeklini belirtiniz.

- * We can produce cable trays different thickness and dimensions
- * Cable trays are shown approximately weight, they could change \pm %10 difference.
- * Cable trays thickness tolerances are shown \pm %10 .
- * Please indicate order code and coating type in your orders.

DS SERIES

DESTEK SİSTEMİ

SUPPORT SYSTEM

PREGALVANİZ (PG)
PREGALVANIZED (PG)
TS EN 10346

SICAK DALDIRMA (SD)
HOT DIP GALVANIZED (HDG)
TS EN ISO 1461

C DESTEK BAĞLANTI ELEMANLARI / C SUPPORT CONNECTION ITEMS

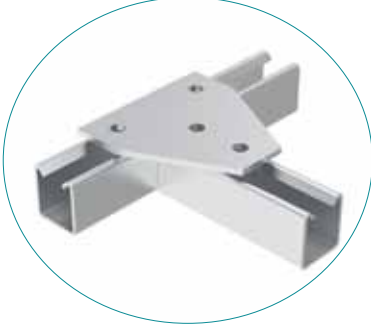

Sipariş Kodu Order Code	T (mm)	Ağırlık (kg/ad) Weight (kg/pcs)	Barkod Kodu Barcode Code
CB-22	5.00 mm	0,466	2003782

PG



Sipariş Kodu Order Code	T (mm)	Ağırlık (kg/ad) Weight (kg/pcs)	Barkod Kodu Barcode Code
CB-22	5.00 mm	0,477	2003782

SD / HDG

T = KALINLIK = THICKNESS

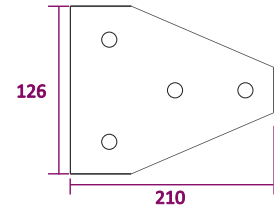

C DESTEK BAĞLANTI ELEMANLARI / C SUPPORT CONNECTION ITEMS

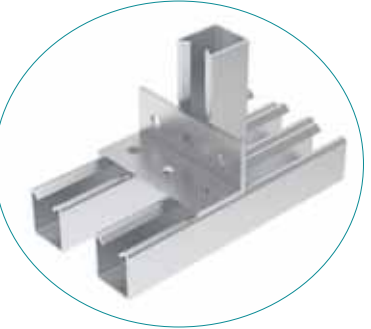

Sipariş Kodu Order Code	T (mm)	Ağırlık (kg/ad) Weight (kg/pcs)	Barkod Kodu Barcode Code
CB-23	5.00 mm	0,412	20037783

PG



Sipariş Kodu Order Code	T (mm)	Ağırlık (kg/ad) Weight (kg/pcs)	Barkod Kodu Barcode Code
CB-23	5.00 mm	0,423	20037783

SD / HDG

T = KALINLIK = THICKNESS

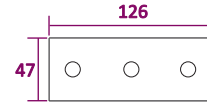

C DESTEK BAĞLANTI ELEMANLARI / C SUPPORT CONNECTION ITEMS

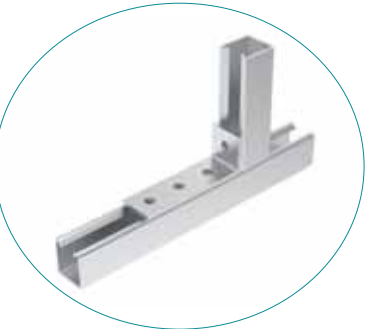

Sipariş Kodu Order Code	T (mm)	Ağırlık (kg/ad) Weight (kg/pcs)	Barkod Kodu Barcode Code
CB-24	5.00 mm	0,292	2003784

PG

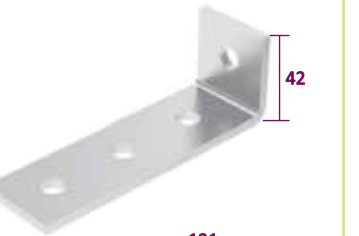

Sipariş Kodu Order Code	T (mm)	Ağırlık (kg/ad) Weight (kg/pcs)	Barkod Kodu Barcode Code
CB-24	5.00 mm	0,299	2003784

SD / HDG

T = KALINLIK = THICKNESS

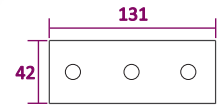

* Farklı kalınlık ve ölçülerde üretim yapıla bilinir.
* Malzeme ağırlıkları yaklaşık değerlerdir, \pm %10 değişiklik gösterebilir.
* Malzeme kalınlık toleransı \pm %10 dur.
* Lütfen siparişlerinizde sipariş kodu veya ürün kodu ve Kaplama şeklini belirtiniz.

* We can produce cable trays different thickness and dimensions
* Cable trays are shown approximately weight, they could change \pm %10 difference.
* Cable trays thickness tolerances are shown \pm %10 .
* Please indicate order code and coating type in your orders.

DS SERIES

DESTEK SİSTEMİ

SUPPORT SYSTEM

PREGALVANİZ (PG)
PREGALVANIZED (PG)
TS EN 10346

SICAK DALDIRMA (SD)
HOT DIP GALVANIZED (HDG)
TS EN ISO 1461

C DESTEK BAĞLANTI ELEMANLARI / C SUPPORT CONNECTION ITEMS

PG

Sipariş Kodu Order Code	T (mm)	Ağırlık (kg/ad) Weight (kg/pcs)	Barkod Kodu Barcode Code
CB-25	5.00 mm	0,336	2003785

SD / HDG

Sipariş Kodu Order Code	T (mm)	Ağırlık (kg/ad) Weight (kg/pcs)	Barkod Kodu Barcode Code
CB-25	5.00 mm	0,345	2003785

T = KALINLIK = THICKNESS

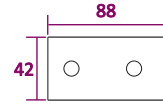
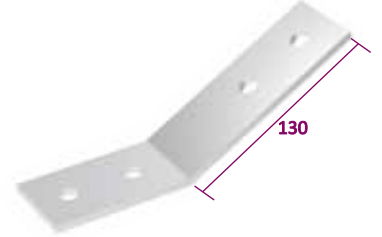

C DESTEK BAĞLANTI ELEMANLARI / C SUPPORT CONNECTION ITEMS

PG

Sipariş Kodu Order Code	T (mm)	Ağırlık (kg/ad) Weight (kg/pcs)	Barkod Kodu Barcode Code
CB-26	5.00 mm	0,247	2003786

SD / HDG

Sipariş Kodu Order Code	T (mm)	Ağırlık (kg/ad) Weight (kg/pcs)	Barkod Kodu Barcode Code
CB-26	5.00 mm	0,253	2003786

T = KALINLIK = THICKNESS

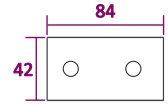

C DESTEK BAĞLANTI ELEMANLARI / C SUPPORT CONNECTION ITEMS

PG

Sipariş Kodu Order Code	T (mm)	Ağırlık (kg/ad) Weight (kg/pcs)	Barkod Kodu Barcode Code
CB-27	5.00 mm	0,264	20037787

SD / HDG

Sipariş Kodu Order Code	T (mm)	Ağırlık (kg/ad) Weight (kg/pcs)	Barkod Kodu Barcode Code
CB-27	5.00 mm	0,271	20037787

T = KALINLIK = THICKNESS

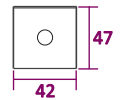

ARTIM METAL ELEKTRİK A.Ş.

* Farklı kalınlık ve ölçülerde üretim yapılabılır.
* Malzeme ağırlıkları yaklaşık değerlerdir, \pm %10 değişiklik gösterebilir.
* Malzeme kalınlık toleransı \pm %10 dur.
* Lütfen siparişlerinizde sipariş kodu veya ürün kodu ve Kaplama şeklini belirtiniz.

* We can produce cable trays different thickness and dimensions
* Cable trays are shown approximately weight, they could change \pm %10 difference.
* Cable trays thickness tolerances are shown \pm %10 .
* Please indicate order code and coating type in your orders.

DS SERIES

DESTEK SİSTEMİ

SUPPORT SYSTEM

PREGALVANİZ (PG)
PREGALVANIZED (PG)
TS EN 10346

SICAK DALDIRMA (SD)
HOT DIP GALVANIZED (HDG)
TS EN ISO 1461

C DESTEK BAĞLANTI ELEMANLARI / C SUPPORT CONNECTION ITEMS

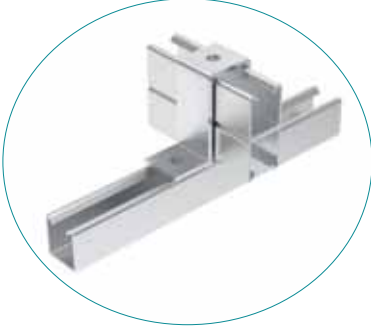

PG			
Sipariş Kodu Order Code	T (mm)	Ağırlık (kg/ad) Weight (kg/pcs)	Barkod Kodu Barcode Code
CB-28	5.00 mm	0,466	2003788

SD / HDG			
Sipariş Kodu Order Code	T (mm)	Ağırlık (kg/ad) Weight (kg/pcs)	Barkod Kodu Barcode Code
CB-28	5.00 mm	0,478	2003788

T = KALINLIK = THICKNESS

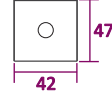

C DESTEK BAĞLANTI ELEMANLARI / C SUPPORT CONNECTION ITEMS

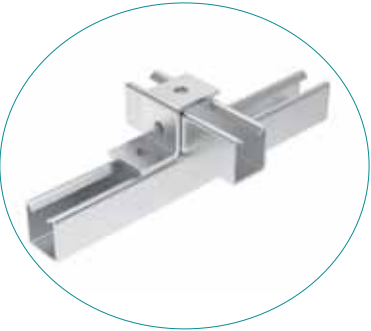

PG			
Sipariş Kodu Order Code	T (mm)	Ağırlık (kg/ad) Weight (kg/pcs)	Barkod Kodu Barcode Code
CB-29	5.00 mm	0,196	2003789

SD / HDG			
Sipariş Kodu Order Code	T (mm)	Ağırlık (kg/ad) Weight (kg/pcs)	Barkod Kodu Barcode Code
CB-29	5.00 mm	0,201	2003789

T = KALINLIK = THICKNESS

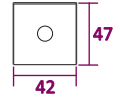
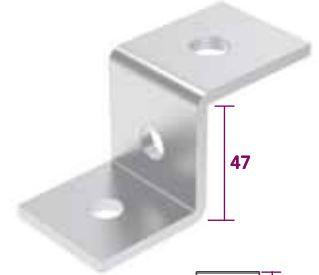

C DESTEK BAĞLANTI ELEMANLARI / C SUPPORT CONNECTION ITEMS

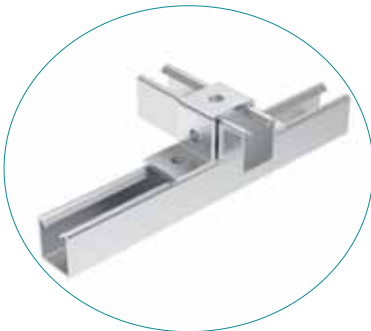

PG			
Sipariş Kodu Order Code	T (mm)	Ağırlık (kg/ad) Weight (kg/pcs)	Barkod Kodu Barcode Code
CB-30	5.00 mm	0,326	2003790

SD / HDG			
Sipariş Kodu Order Code	T (mm)	Ağırlık (kg/ad) Weight (kg/pcs)	Barkod Kodu Barcode Code
CB-30	5.00 mm	0,334	2003790

T = KALINLIK = THICKNESS

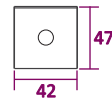

* Farklı kalınlık ve ölçülerde üretim yapılabılır.
* Malzeme ağırlıkları yaklaşık değerlerdir, \pm %10 değişiklik gösterebilir.
* Malzeme kalınlık toleransı \pm %10 dur.
* Lütfen siparişlerinizde sipariş kodu veya ürün kodu ve kaplama şeklini belirtiniz.

* We can produce cable trays different thickness and dimensions
* Cable trays are shown approximately weight, they could change \pm %10 difference.
* Cable trays thickness tolerances are shown \pm %10 .
* Please indicate order code and coating type in your orders.

DS SERIES

DESTEK SİSTEMİ

SUPPORT SYSTEM

PREGALVANİZ (PG)
PREGALVANIZED (PG)
TS EN 10346

SICAK DALDIRMA (SD)
HOT DIP GALVANIZED (HDG)
TS EN ISO 1461

C DESTEK BAĞLANTI ELEMANLARI / C SUPPORT CONNECTION ITEMS

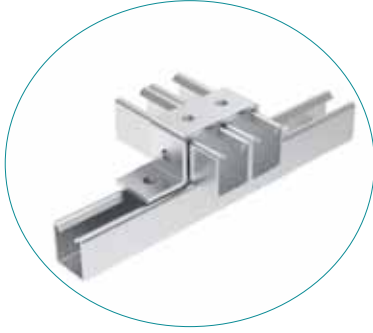

Sipariş Kodu Order Code	T (mm)	Ağırlık (kg/ad) Weight (kg/pcs)	Barkod Kodu Barcode Code
CB-31	5.00 mm	0,391	20037791

Sipariş Kodu Order Code	T (mm)	Ağırlık (kg/ad) Weight (kg/pcs)	Barkod Kodu Barcode Code
CB-31	5.00 mm	0,401	20037791

T = KALINLIK = THICKNESS

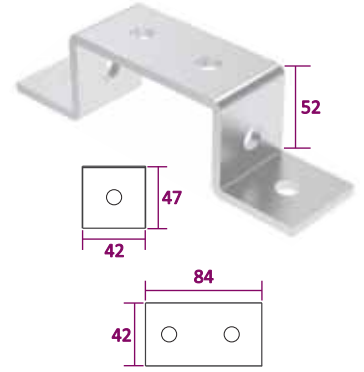

BAĞLANTI ELEMANLARI / CONNECTION ITEMS



ANS



ATC



ANSY

Sipariş Kodu Order Code	Ebat (mm) Size (mm)	Açıklama Description	Ağırlık (kg/ad) Weight (kg/ad)	Barkod Kodu Barcode Code
ANS-1	M8	N SOMUN / N NUTS	0,038	2004261
ANS-2	M10	N SOMUN / N NUTS	0,040	2004262
ANS-3	M12	N SOMUN / N NUTS	0,042	2004263
ATC-1	M8x40	T CİVATA / T BOLT	0,054	2004264
ATC-2	M10x40	T CİVATA / T BOLT	0,058	2004265
ATC-3	M12x40	T CİVATA / T BOLT	0,062	2004266
ANSY-1	M8x40	YAYLI SOMUN/SPRING NUT	0,046	2004267
ANSY-2	M10x40	YAYLI SOMUN/SPRING NUT	0,048	2004268
ANSY-3	M12x40	YAYLI SOMUN/SPRING NUT	0,052	2004269

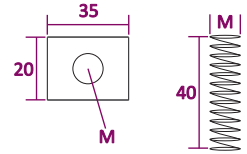
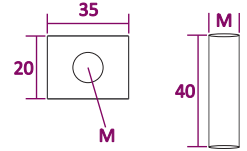
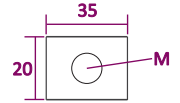

ARTIM METAL ELEKTRİK A.Ş.

* Farklı kalınlık ve ölçülerde üretim yapılabılır.
* Malzeme ağırlıkları yaklaşık değerlerdir, \pm %10 değişiklik gösterebilir.
* Malzeme kalınlık toleransı \pm %10 dur.
* Lütfen siparişlerinizde sipariş kodu veya ürün kodu ve Kaplama şeklini belirtiniz.

* We can produce cable trays different thickness and dimensions
* Cable trays are shown approximately weight, they could change \pm %10 difference.
* Cable trays thickness tolerances are shown \pm %10 .
* Please indicate order code and coating type in your orders.

art

POWER CARRYING SOLUTIONS



TOPRAKLAMA ELEMANLARI

GROUNDING ELEMENTS



AT SERIES

TOPRAKLAMA ELEMANLARI

GROUNDING ELEMENTS

PREGALVANİZ (PG)
PREGALVANIZED (PG)
TS EN 10346

SICAK DALDIRMA (SD)
HOT DIP GALVANIZED (HDG)
TS EN ISO 1461

TOPRAKLAMA ŞERİDİ / GROUNDING STRAP

PG

Sipariş Kodu Order Code	W (mm)	T (mm)	Ağırlık (kg/m) Weight (kg/m)	Barkod Kodu Barcode Code
ATS 30-3	30	3.00 mm	0,707	2004400
ATS 30-4	30	4.00 mm	0,942	2004401
ATS 40-3	40	3.00 mm	0,942	2004402
ATS 40-4	40	4.00 mm	1,256	2004403

SD / HDG

Sipariş Kodu Order Code	W (mm)	T (mm)	Ağırlık (kg/m) Weight (kg/m)	Barkod Kodu Barcode Code
ATS 30-3	30	3.00 mm	0,778	2004400
ATS 30-4	30	4.00 mm	1,036	2004401
ATS 40-3	40	3.00 mm	1,036	2004402
ATS 40-4	40	4.00 mm	1,382	2004403

W = GENİŞLİK = WIDTH / T = KALINLIK = THICKNESS



GALVANİZLİ MONO TEL / GALVANISED MONO CONDUCTOR

SD/HDG

Sipariş Kodu Order Code	Ebat (mm) Size (mm)	KESİT (mm)	Ağırlık (kg/m) Weight (kg/m)	Barkod Kodu Barcode Code
AMT 08	M8	50	0,430	2004410
AMT 10	M10	70	0,642	2004411



ARTIM METAL ELEKTRİK A.Ş.

* Farklı kalınlık ve ölçülerde üretim yapılabılır.
* Malzeme ağırlıkları yaklaşık değerlerdir, \pm %10 değişiklik gösterebilir.
* Malzeme kalınlık toleransı \pm %10 dur.
* Lütfen siparişlerinizde sipariş kodu veya ürün kodu ve Kaplama şeklini belirtiniz.

* We can produce cable trays different thickness and dimensions
* Cable trays are shown approximately weight, they could change \pm %10 difference.
* Cable trays thickness tolerances are shown \pm %10 .
* Please indicate order code and coating type in your orders.

AT SERIES

TOPRAKLAMA ELEMANLARI

GROUNDING ELEMENTS

PREGALVANİZ (PG)
PREGALVANIZED (PG)
TS EN 10346

BAĞLANTI KLEMENSİ / JOINTING CLAMP

Sipariş Kodu Order Code	W1 (mm)	W2 (mm)	Ağırlık (kg/ad) Weight (kg/pcs)	Paket Miktarı (Ad) Package Content (Pcs)	PG
					Barkod Kodu Barcode Code
ATK 301	30	30	0,121	100	2004420
ATK 302	30	Q22	0,137	75	2004421
ATK 401	40	40	0,300	75	2004423
ATK 402	40	Q22	0,300	50	2004424

W = GENİŞLİK = WIDTH / T = KALINLIK = THICKNESS



ATK 301



ATK 401



ATK 302 / ATK 402

1 Adet Klemens için;
4 adet M6x15 Anahtar Baslı Civata + 4 adet M6 Somun kullanılmaktadır.
Ürün Civata Somun dahil Takim olarak satılmaktadır.
For One piece Jointing Clamp;
4 Piece M6x15 Key Head Bolts + 4 Piece M6 Nuts are used.
The product is sold as a Set including Bolt Nut.

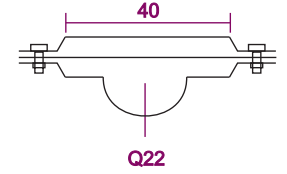
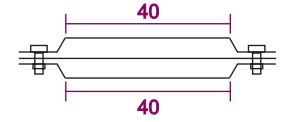
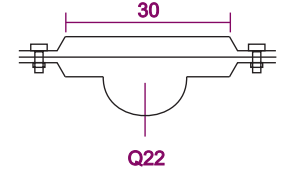
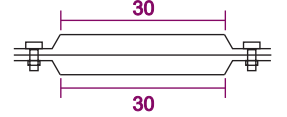

BAĞLANTI KLEMENSİ / JOINTING CLAMP

Sipariş Kodu Order Code	İletken Conductor	Kesit Section	Ağırlık (kg/ad) Weight (kg/pcs)	PG
				Barkod Kodu Barcode Code
ATKA 01	16-20	30x3	0,080	2004481
ATKA 02	22-26	30x3	0,090	2004482
ATKA 03	28-32	30x3	0,090	2004483
ATKA 04	16-20	30x3	0,120	2004484
ATKA 05	26-32	40x4	0,400	2004485



* Farklı kalınlık ve ölçülerde üretim yapılabilmektedir.
* Malzeme ağırlıkları yaklaşık değerlerdir, \pm %10 değişiklik gösterebilir.
* Malzeme kalınlık toleransı \pm %10 dur.
* Lütfen siparişlerinizde sipariş kodu veya ürün kodu ve kaplama şeklini belirtiniz.

* We can produce cable trays different thickness and dimensions
* Cable trays are shown approximately weight, they could change \pm %10 difference.
* Cable trays thickness tolerances are shown \pm %10 .
* Please indicate order code and coating type in your orders.

AT SERIES

TOPRAKLAMA ELEMANLARI

GROUNDING ELEMENTS

SICAK DALDIRMA (SD)

HOT DIP GALVANIZED (HDG)

TS EN ISO 1461



TOPRAKLAMA ELEKTRODU / EARTHING ELECTRODE

4.00 mm

Sipariş Kodu Order Code	Ebat (mm) Size (mm)	L (mm)	Ağırlık (kg/ad) Weight (kg/pcs)	Barkod Kodu Barcode Code
ATE 40x40x4 -10	40x40	1.000	2,512	2004430
ATE 40x40x4 -15	40x40	1.500	3,768	2004431
ATE 50x50x4 -10	50x50	1.000	3,140	2004432
ATE 50x50x4 -15	50x50	1.500	4,710	2004433
ATE 60x60x4 -10	60x60	1.000	3,768	2004434
ATE 60x60x4 -15	60x60	1.500	5,652	2004435

5.00 mm

Sipariş Kodu Order Code	Ebat (mm) Size (mm)	L (mm)	Ağırlık (kg/ad) Weight (kg/pcs)	Barkod Kodu Barcode Code
ATE 40x40x5 -10	40x40	1.000	3,140	2004436
ATE 40x40x5 -15	40x40	1.500	4,710	2004437
ATE 50x50x5 -10	50x50	1.000	3,925	2004438
ATE 50x50x5 -15	50x50	1.500	5,888	2004439
ATE 60x60x5 -10	60x60	1.000	4,710	2004440
ATE 60x60x5 -15	60x60	1.500	7,065	2004441
ATE 65x65x5 -10	65x65	1.000	5,102	2004442
ATE 65x65x5 -15	65x65	1.500	7,653	2004443

6.00 mm

Sipariş Kodu Order Code	Ebat (mm) Size (mm)	L (mm)	Ağırlık (kg/ad) Weight (kg/pcs)	Barkod Kodu Barcode Code
ATE 60x60x6 -10	60x60	1.000	5,652	2004444
ATE 60x60x6 -15	60x60	1.500	8,478	2004445
ATE 65x65x6 -10	65x65	1.000	6,123	2004446
ATE 65x65x6 -15	65x65	1.500	9,184	2004447

L = BOY = LENGTH



Elektro Galvaniz talep üzerine de üretilebilir.
Electro Galvanized can also be produced upon request.

TOPRAKLAMA ÇUBUĞU / EARTHING ROD

Sipariş Kodu Order Code	Ebat (mm) Size (mm)	L (mm)	Ağırlık (kg/ad) Weight (kg/pcs)	Barkod Kodu Barcode Code
ATEC Q16 -10	Q16	1.000	1,600	2004451
ATEC Q16 -15	Q16	1.500	2,400	2004452
ATEC Q18 -10	Q18	1.000	2,100	2004453
ATEC Q18 -15	Q18	1.500	3,100	2004454
ATEC Q20 -10	Q20	1.000	2,600	2004455
ATEC Q20 -15	Q20	1.500	3,900	2004456

L = BOY = LENGTH



Beyaz ve Sarı olarak üretilebilir.
It can be produced in white and yellow.

ARTIM METAL ELEKTRİK A.Ş.

* Farklı kalınlık ve ölçülerde üretim yapılabılır.
* Malzeme ağırlıkları yaklaşık değerlerdir, \pm %10 değişiklik gösterebilir.
* Malzeme kalınlık toleransı \pm %10 dur.
* Lütfen siparişlerinizde sipariş kodu veya ürün kodu ve Kaplama şeklini belirtiniz.

* We can produce cable trays different thickness and dimensions
* Cable trays are shown approximately weight, they could change \pm %10 difference.
* Cable trays thickness tolerances are shown \pm %10 .
* Please indicate order code and coating type in your orders.

AT SERIES

TOPRAKLAMA ELEMANLARI

GROUNDING ELEMENTS

PREGALVANİZ (PG)
PREGALVANIZED (PG)
TS EN 10346

PARATONERLER / ACTIVE LIGHTNING CONDUCTORS

Sipariş Kodu Order Code	Ebat (m) Size (m)	L (m)	Ağırlık (kg/ad) Weight (kg/pcs)	Barkod Kodu Barcode Code
AYP TS 01	0,85 m	60	9,360	2004461
AYP TFTC	75X37x111		0,130	2004462
AYP TK 01	-	5	0,300	2004463
AYP TK 02	-	10	0,600	2004464

MAXİMUM KORUMA ÇAPI / PROTECTED DIAMETRE = 214 MT

Uygunluk Test Belgesi / Test Certificated of conformity in



AYP TS 01



AYP TFTC



AYP TK

Maximum Koruma Çapı = 214 MT. ,Uygunluk Test Belgesi.
Protected Diametre = 214 MT. , Test Certificated of conformity in.

PARATONERLER / ACTIVE LIGHTNING CONDUCTORS

Sipariş Kodu Order Code	Ebat (m) Size (m)	L (m)	Ağırlık (kg/ad) Weight (kg/pcs)	Barkod Kodu Barcode Code
AYP FP 01	0,50 m	60	3,000	2004465
AYP TFTC	75X37x111	-	0,130	2004462
AYP TK 01	-	5	0,300	2004463
AYP TK 02	-	10	0,600	2004464

MAXİMUM KORUMA ÇAPI / PROTECTED DIAMETRE = 214 MT

Uygunluk Test Belgesi / Test Certificated of conformity in



AYP FP 01



AYP TFTC



AYP TK

Maximum Koruma Çapı = 214 MT. ,Uygunluk Test Belgesi.
Protected Diametre = 214 MT. , Test Certificated of conformity in.

* Farklı kalınlık ve ölçülerde üretim yapılabılır.
* Malzeme ağırlıkları yaklaşık değerlerdir, \pm %10 değişiklik gösterebilir.
* Malzeme kalınlık toleransı \pm %10 dur.
* Lütfen siparişlerinizde sipariş kodu veya ürün kodu ve Kaplama şeklini belirtiniz.

* We can produce cable trays different thickness and dimensions
* Cable trays are shown approximately weight, they could change \pm %10 difference.
* Cable trays thickness tolerances are shown \pm %10 .
* Please indicate order code and coating type in your orders.

AT SERIES

TOPRAKLAMA ELEMANLARI

GROUNDING ELEMENTS

PREGALVANİZ (PG)

PREGALVANIZED (PG)

TS EN 10346

ORTA TİP TABAN / MIDDLE TYPE BASE

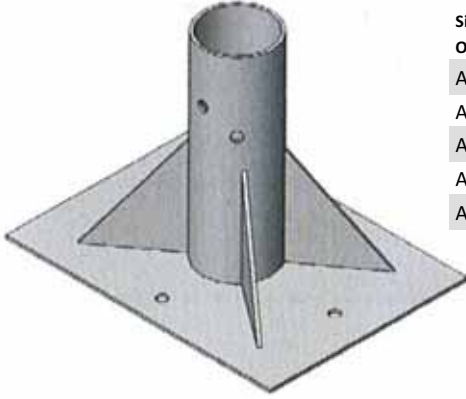

Sipariş Kodu Order Code	Direk Çapı Pole Diameter	Ağırlık (kg/ad) Weight (kg/pcs)	Barkod Kodu Barcode Code
AYS OTT 01	1.25 "	3,500	2004471
AYS OTT 02	1.50 "	4,000	2004472
AYS OTT 03	2.00 "	4,500	2004473
AYS OTT 04	2.50 "	5,000	2004474
AYS OTT 05	3.00 "	5,500	2004475

PG

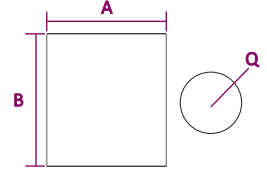

GERDİRME / TURNBUCKLE



Sipariş Kodu Order Code	Ebat (mm) Size (mm)	L (mm)	Ağırlık (kg/ad) Weight (kg/pcs)	Barkod Kodu Barcode Code
ATG 01	M6	100	0,085	2004451
ATG 02	M8	125	0,100	2004452
ATG 03	M10	150	0,125	2004453
ATG 04	M12	200	0,150	2004454
ATG 05	M16	250	0,200	2004455
ATG 06	M18	280	0,225	2004456

L = BOY = LENGTH



ARTIM METAL ELEKTRİK A.Ş.

- * Farklı kalınlık ve ölçülerde üretim yapılabılır.
- * Malzeme ağırlıkları yaklaşık değerlerdir, \pm %10 değişiklik gösterebilir.
- * Malzeme kalınlık toleransı \pm %10 dur.
- * Lütfen siparişlerinizde sipariş kodu veya ürün kodu ve Kaplama şeklini belirtiniz.

- * We can produce cable trays different thickness and dimensions
- * Cable trays are shown approximately weight, they could change \pm %10 difference.
- * Cable trays thickness tolerances are shown \pm %10 .
- * Please indicate order code and coating type in your orders.

AT SERIES

TOPRAKLAMA ELEMANLARI

GROUNDING ELEMENTS

PREGALVANİZ (PG)
PREGALVANIZED (PG)
TS EN 10346

L BAĞLANTI KLEMENSİ / L JOINTING CLAMP

PG

Sipariş Kodu Order Code	İletken Conductor	Ağırlık (kg/ad) Weight (kg/pcs)	Barkod Kodu Barcode Code
ATLK 01	2.00 mm	0,020	2004495
ATLK 02	2.00 mm	0,042	2004496

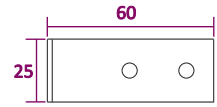
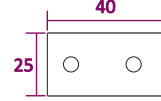
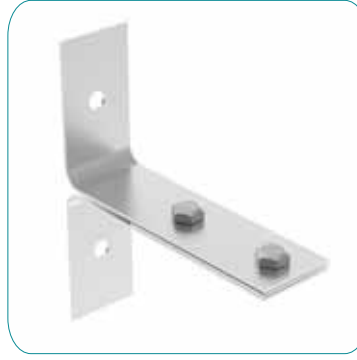

1 Adet Klemens için;
2 adet M6x15 Anahtar Baslı Civata + 2 adet M6 Somun kullanılmaktadır.
Ürün Civata Somun dahil Takim olarak satılmaktadır.
For One piece Jointing Clamp;
2 Piece M6x15 Key Head Bolts + 2 Piece M6 Nuts are used.
The product is sold as a Set including Bolt Nut.

L BAĞLANTI KLEMENSİ / L JOINTING CLAMP

PG

Sipariş Kodu Order Code	İletken Conductor	Ağırlık (kg/ad) Weight (kg/pcs)	Barkod Kodu Barcode Code
ATLK 03	2.00 mm	0,024	2004497
ATLK 02	2.00 mm	0,042	2004496

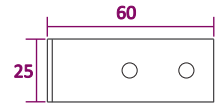
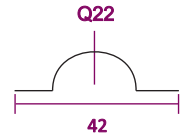

1 Adet Klemens için;
2 adet M6x15 Anahtar Baslı Civata + 2 adet M6 Somun kullanılmaktadır.
Ürün Civata Somun dahil Takim olarak satılmaktadır.
For One piece Jointing Clamp;
2 Piece M6x15 Key Head Bolts + 2 Piece M6 Nuts are used.
The product is sold as a Set including Bolt Nut.

* Farklı kalınlık ve ölçülerde üretim yapılabılır.
* Malzeme ağırlıkları yaklaşık değerlerdir, \pm %10 değişiklik gösterebilir.
* Malzeme kalınlık toleransı \pm %10 dur.
* Lütfen siparişlerinizde sipariş kodu veya ürün kodu ve Kaplama şeklini belirtiniz.

* We can produce cable trays different thickness and dimensions
* Cable trays are shown approximately weight, they could change \pm %10 difference.
* Cable trays thickness tolerances are shown \pm %10 .
* Please indicate order code and coating type in your orders.

AT SERIES

TOPRAKLAMA ELEMANLARI

GROUNDING ELEMENTS

CIVATA TIP TESPİT KROŞELERİ / BOLT TYPE FIXING CLAMPS



PG

Sipariş Kodu Order Code	İletken Conductor	Ağırlık (kg/ad) Weight (kg/pcs)	Barkod Kodu Barcode Code
ACTK 01	8 mm	0,080	2004480

BAKIR / COPPER

Sipariş Kodu Order Code	İletken Conductor	Ağırlık (kg/ad) Weight (kg/pcs)	Barkod Kodu Barcode Code
ACTK 02	8 mm	0,090	2004480

PİRİNÇ / BRASS

Sipariş Kodu Order Code	İletken Conductor	Ağırlık (kg/ad) Weight (kg/pcs)	Barkod Kodu Barcode Code
ACTK 03	8 mm	0,085	2004480

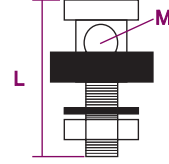

BRANŞMAN & DURDURUCU KLEMENSLER / JOINTING & STOPPING CLAMPS

AL

Sipariş Kodu Order Code	Kesit (mm ²) Section (mm ²)	Ağırlık (kg/ad) Weight (kg/pcs)	Barkod Kodu Barcode Code
ABK ALCU 01	A25-B16	0,025	2004481
ABK ALCU 02	A40-B25	0,031	2004482
ABK ALCU 03	A70-B50	0,056	2004483
ABK ALCU 04	A120-B70	0,092	2004484
ABK ALCU 05	A240-B120	0,215	2004485

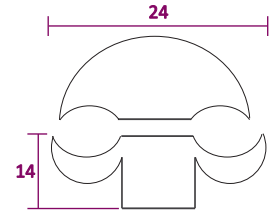

AL

Sipariş Kodu Order Code	Kesit (mm ²) Section (mm ²)	Ağırlık (kg/ad) Weight (kg/pcs)	Barkod Kodu Barcode Code
ADK ALCU 01	16-50	0,070	2004491
ADK ALCU 02	50-95	0,122	2004492



ARTIM METAL ELEKTRİK A.Ş.

* Farklı kalınlık ve ölçülerde üretim yapılabılır.
* Malzeme ağırlıkları yaklaşık değerlerdir, ± %10 değişiklik gösterebilir.
* Malzeme kalınlık toleransı ± %10 dur.
* Lütfen siparişlerinizde sipariş kodu veya ürün kodu ve Kaplama şeklini belirtiniz.

* We can produce cable trays different thickness and dimensions
* Cable trays are shown approximately weight, they could change ± %10 difference.
* Cable trays thickness tolerances are shown ± %10 .
* Please indicate order code and coating type in your orders.

art

POWER CARRYING SOLUTIONS



GEMİ TİPİ KABLO KANALLARI

MARINE TYPE CABLE TRAYS



AG SERIES

H15 GEMI TIPI KABLO KANALLARI

H15 MARINE TYPE CABLE TRAYS

PREGALVANİZ (PG)
PREGALVANIZED (PG)
TS EN 10346



1.00 mm

Sipariş Kodu Order Code	W (mm)	T (mm)	Ağırlık (kg/m) Weight (kg/m)	Barkod Kodu Barcode Code
15 AGK 050-10	50	1.00 mm	0,523	2009001
15 AGK 100-10	100	1.00 mm	0,876	2009002
15 AGK 200-10	200	1.00 mm	1,583	2009003
15 AGK 300-10	300	1.00 mm	2,289	2009004

1.20 mm

Sipariş Kodu Order Code	W (mm)	T (mm)	Ağırlık (kg/m) Weight (kg/m)	Barkod Kodu Barcode Code
15 AGK 050-12	50	1.20 mm	0,627	2009005
15 AGK 100-12	100	1.20 mm	1,051	2009006
15 AGK 200-12	200	1.20 mm	1,899	2009007
15 AGK 300-12	300	1.20 mm	2,747	2009008

1.50 mm

Sipariş Kodu Order Code	W (mm)	T (mm)	Ağırlık (kg/m) Weight (kg/m)	Barkod Kodu Barcode Code
15 AGK 050-15	50	1.50 mm	0,784	2009009
15 AGK 100-15	100	1.50 mm	1,314	2009010
15 AGK 200-15	200	1.50 mm	2,374	2009011
15 AGK 300-15	300	1.50 mm	3,434	2009012

H = YÜKSEKLİK = HEIGHT / W = GENİŞLİK = WIDTH / T = KALINLIK = THICKNESS

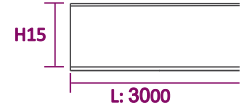

SICAK DALDIRMA (SD)
HOT DIP GALVANIZED (SD)
TS EN ISO 1461

1.00 mm

Sipariş Kodu Order Code	W (mm)	T (mm)	Ağırlık (kg/m) Weight (kg/m)	Barkod Kodu Barcode Code
15 AGK 050-10	50	1.00 mm	0,575	2009001
15 AGK 100-10	100	1.00 mm	0,964	2009002
15 AGK 200-10	200	1.00 mm	1,741	2009003
15 AGK 300-10	300	1.00 mm	2,518	2009004

1.20 mm

Sipariş Kodu Order Code	W (mm)	T (mm)	Ağırlık (kg/m) Weight (kg/m)	Barkod Kodu Barcode Code
15 AGK 050-12	50	1.20 mm	0,690	2009005
15 AGK 100-12	100	1.20 mm	1,156	2009006
15 AGK 200-12	200	1.20 mm	2,089	2009007
15 AGK 300-12	300	1.20 mm	3,022	2009008

1.50 mm

Sipariş Kodu Order Code	W (mm)	T (mm)	Ağırlık (kg/m) Weight (kg/m)	Barkod Kodu Barcode Code
15 AGK 050-15	50	1.50 mm	0,863	2009009
15 AGK 100-15	100	1.50 mm	1,445	2009010
15 AGK 200-15	200	1.50 mm	2,611	2009011
15 AGK 300-15	300	1.50 mm	3,777	2009012

H = YÜKSEKLİK = HEIGHT / W = GENİŞLİK = WIDTH / T = KALINLIK = THICKNESS

ARTIM METAL ELEKTRİK A.Ş.

* Farklı kalınlık ve ölçülerde üretim yapılabılır.
* Malzeme ağırlıkları yaklaşık değerlerdir, \pm %10 değişiklik gösterebilir.
* Malzeme kalınlık toleransı \pm %10 dur.
* Lütfen siparişlerinizde sipariş kodu veya ürün kodu ve Kaplama şeklini belirtiniz.

* We can produce cable trays different thickness and dimensions
* Cable trays are shown approximately weight, they could change \pm %10 difference.
* Cable trays thickness tolerances are shown \pm %10 .
* Please indicate order code and coating type in your orders.

AG SERIES

H15 GEMİ TIPI KABLO KANALLARI

H15 MARINE TYPE CABLE TRAYS

PREGALVANİZ (PG)
PREGALVANIZED (PG)
TS EN 10346

SICAK DALDIRMA (SD)
HOT DIP GALVANIZED (HDG)
TS EN ISO 1461

90° DÖNÜŞ ELEMANI / 90° BEND



				PG
Sipariş Kodu Order Code	W (mm)	T (mm)	Ağırlık (kg/ad) Weight (kg/ad)	Barkod Kodu Barcode Code
15 AGK 050Y	50	1.00 mm	0,384	2009031
15 AGK 100Y	100	1.00 mm	0,679	2009032
15 AGK 200Y	200	1.00 mm	1,296	2009033
15 AGK 300Y	300	1.00 mm	2,111	2009034

				SD/HDG
Sipariş Kodu Order Code	W (mm)	T (mm)	Ağırlık (kg/ad) Weight (kg/ad)	Barkod Kodu Barcode Code
15 AGK 050Y	50	1.00 mm	0,422	2009031
15 AGK 100Y	100	1.00 mm	0,747	2009032
15 AGK 200Y	200	1.00 mm	1,426	2009033
15 AGK 300Y	300	1.00 mm	2,322	2009034

H = YÜKSEKLİK = HEIGHT / W = GENİŞLİK = WIDTH / T = KALINLIK = THICKNESS

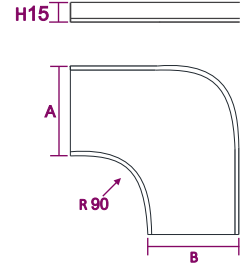

İÇ&DIŞ BÜKEY DÖNÜŞ (HAREKETLİ) / ADJUSTABLE INSIDE&OUTSIDE VERTICAL BENDS



				PG
Sipariş Kodu Order Code	W (mm)	T (mm)	Ağırlık (kg/ad) Weight (kg/ad)	Barkod Kodu Barcode Code
15 AGK 050B	50	1.00 mm	0,488	2009041
15 AGK 100B	100	1.00 mm	0,817	2009042
15 AGK 200B	200	1.00 mm	2,215	2009043
15 AGK 300B	300	1.00 mm	3,204	2009044

				SD/HDG
Sipariş Kodu Order Code	W (mm)	T (mm)	Ağırlık (kg/ad) Weight (kg/ad)	Barkod Kodu Barcode Code
15 AGK 050B	50	1.00 mm	0,537	2009041
15 AGK 100B	100	1.00 mm	0,899	2009042
15 AGK 200B	200	1.00 mm	2,437	2009043
15 AGK 300B	300	1.00 mm	3,524	2009044

H = YÜKSEKLİK = HEIGHT / W = GENİŞLİK = WIDTH / T = KALINLIK = THICKNESS

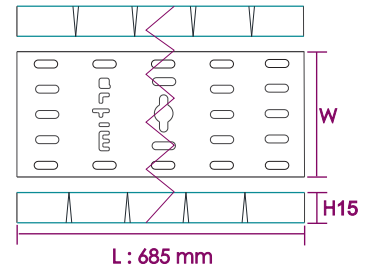

* Farklı kalınlık ve ölçülerde üretim yapılabılır.
* Malzeme ağırlıkları yaklaşık değerlerdir, ± %10 değişiklik gösterebilir.
* Malzeme kalınlık toleransı ± %10 dur.
* Lütfen siparişlerinizde sipariş kodu veya ürün kodu ve kaplama şeklini belirtiniz.

* We can produce cable trays different thickness and dimensions
* Cable trays are shown approximately weight, they could change ± %10 difference.
* Cable trays thickness tolerances are shown ± %10 .
* Please indicate order code and coating type in your orders.

AG SERIES

GEMİ TIPI KABLO MERDİVENİ

MARINE TYPE CABLE LADDER

SICAK DALDIRMA (SD)
HOT DIP GALVANIZED (SD)
TS EN ISO 1461



H40 Yan kenara 40x4 mm Silme lama demir kullanılır.
H50 Yan kenara 50x5 mm Silme lama demir kullanılır.
H40 Side edge 40x4 mm wipe blade iron is used.
H50 Side edge 50x5 mm wipe blade iron is used.

H40

Sipariş Kodu Order Code	W (mm)	T (mm)	Ağırlık (kg/m) Weight (kg/m)	Barkod Kodu Barcode Code
40 AGM 100-4	100	4.00 mm	2,813	2009051
40 AGM 150-4	150	4.00 mm	2,976	2009052
40 AGM 200-4	200	4.00 mm	3,140	2009053
40 AGM 250-4	250	4.00 mm	3,303	2009054
40 AGM 300-4	300	4.00 mm	3,466	2009055
40 AGM 400-4	400	4.00 mm	3,792	2009056
40 AGM 500-4	500	4.00 mm	4,119	2009057
40 AGM 600-4	600	4.00 mm	4,445	2009058

H = YÜKSEKLİK = HEIGHT / W = GENİŞLİK = WIDTH / T = KALINLIK = THICKNESS

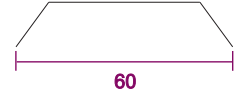

H50

Sipariş Kodu Order Code	W (mm)	T (mm)	Ağırlık (kg/m) Weight (kg/m)	Barkod Kodu Barcode Code
50 AGM 100-5	100	5.00 mm	4,212	2009059
50 AGM 150-5	150	5.00 mm	4,375	2009060
50 AGM 200-5	200	5.00 mm	4,539	2009061
50 AGM 250-5	250	5.00 mm	4,702	2009062
50 AGM 300-5	300	5.00 mm	4,865	2009063
50 AGM 400-5	400	5.00 mm	5,191	2009064
50 AGM 500-5	500	5.00 mm	5,518	2009065
50 AGM 600-5	600	5.00 mm	5,844	2009066

H = YÜKSEKLİK = HEIGHT / W = GENİŞLİK = WIDTH / T = KALINLIK = THICKNESS



H40

Sipariş Kodu Order Code	W (mm)	T (mm)	Ağırlık (kg/m) Weight (kg/m)	Barkod Kodu Barcode Code
40 AGM 100-4D	100	4.00 mm	2,720	2009071
40 AGM 150-4D	150	4.00 mm	2,877	2009072
40 AGM 200-4D	200	4.00 mm	3,035	2009073
40 AGM 250-4D	250	4.00 mm	3,193	2009074
40 AGM 300-4D	300	4.00 mm	3,351	2009075
40 AGM 400-4D	400	4.00 mm	3,666	2009076
40 AGM 500-4D	500	4.00 mm	3,982	2009077
40 AGM 600-4D	600	4.00 mm	4,297	2009078

H = YÜKSEKLİK = HEIGHT / W = GENİŞLİK = WIDTH / T = KALINLIK = THICKNESS

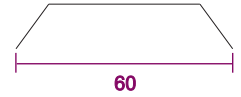
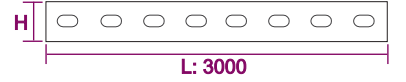

H50

Sipariş Kodu Order Code	W (mm)	T (mm)	Ağırlık (kg/m) Weight (kg/m)	Barkod Kodu Barcode Code
50 AGM 100-5D	100	5.00 mm	4,072	2009079
50 AGM 150-5D	150	5.00 mm	4,230	2009080
50 AGM 200-5D	200	5.00 mm	4,387	2009081
50 AGM 250-5D	250	5.00 mm	4,545	2009082
50 AGM 300-5D	300	5.00 mm	4,703	2009083
50 AGM 400-5D	400	5.00 mm	5,018	2009084
50 AGM 500-5D	500	5.00 mm	5,334	2009085
50 AGM 600-5D	600	5.00 mm	5,649	2009086

H = YÜKSEKLİK = HEIGHT / W = GENİŞLİK = WIDTH / T = KALINLIK = THICKNESS



H40 Yan kenara 40x4 mm Silme lama demir kullanılır.
H50 Yan kenara 50x5 mm Silme lama demir kullanılır.
H40 Side edge 40x4 mm wipe blade iron is used.
H50 Side edge 50x5 mm wipe blade iron is used.

TS 149 Elektro Galvaniz üretim de yapılmaktadır.
TS 149 Electro Galvanized production is also available.

ARTIM METAL ELEKTRİK A.Ş.

- * Farklı kalınlık ve ölçülerde üretim yapılabılır.
- * Malzeme ağırlıkları yaklaşık değerlerdir, \pm %10 değişiklik gösterebilir.
- * Malzeme kalınlık toleransı \pm %10 dur.
- * Lütfen siparişlerinizde sipariş kodu veya ürün kodu ve Kaplama şeklini belirtiniz.

- * We can produce cable trays different thickness and dimensions
- * Cable trays are shown approximately weight, they could change \pm %10 difference.
- * Cable trays thickness tolerances are shown \pm %10 .
- * Please indicate order code and coating type in your orders.

AG SERIES

GEMİ TIPI KABLO MERDİVENİ

MARINE TYPE CABLE LADDER

SICAK DALDIRMA (SD)

HOT DIP GALVANIZED (SD)

TS EN ISO 1461



H40 Yan kenara 40x4 mm Silme lama demir kullanılır.
H50 Yan kenara 50x5 mm Silme lama demir kullanılır.
H40 Side edge 40x4 mm wipe blade iron is used.
H50 Side edge 50x5 mm wipe blade iron is used.

H40

Sipariş Kodu Order Code	W (mm)	T (mm)	Ağırlık (kg/m) Weight (kg/m)	Barkod Kodu Barcode Code
40 AGMZ 100-4	100	4.00 mm	3,046	2009091
40 AGMZ 150-4	150	4.00 mm	3,326	2009092
40 AGMZ 200-4	200	4.00 mm	3,606	2009093
40 AGMZ 250-4	250	4.00 mm	3,886	2009094
40 AGMZ 300-4	300	4.00 mm	4,166	2009095
40 AGMZ 400-4	400	4.00 mm	4,725	2009096
40 AGMZ 500-4	500	4.00 mm	5,285	2009097
40 AGMZ 600-4	600	4.00 mm	5,844	2009098

H = YÜKSEKLİK = HEIGHT / W = GENİŞLİK = WIDTH / T = KALINLIK = THICKNESS

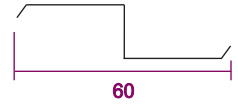

H50

Sipariş Kodu Order Code	W (mm)	T (mm)	Ağırlık (kg/m) Weight (kg/m)	Barkod Kodu Barcode Code
50 AGMZ 100-5	100	5.00 mm	4,445	2009099
50 AGMZ 150-5	150	5.00 mm	4,725	2009100
50 AGMZ 200-5	200	5.00 mm	5,005	2009101
50 AGMZ 250-5	250	5.00 mm	5,285	2009102
50 AGMZ 300-5	300	5.00 mm	5,564	2009103
50 AGMZ 400-5	400	5.00 mm	6,124	2009104
50 AGMZ 500-5	500	5.00 mm	6,683	2009105
50 AGMZ 600-5	600	5.00 mm	7,243	2009106

H = YÜKSEKLİK = HEIGHT / W = GENİŞLİK = WIDTH / T = KALINLIK = THICKNESS



H40

Sipariş Kodu Order Code	W (mm)	T (mm)	Ağırlık (kg/m) Weight (kg/m)	Barkod Kodu Barcode Code
40 AGMZ 100-4D	100	4.00 mm	2,945	2009071
40 AGMZ 150-4D	150	4.00 mm	3,215	2009072
40 AGMZ 200-4D	200	4.00 mm	3,486	2009073
40 AGMZ 250-4D	250	4.00 mm	3,756	2009074
40 AGMZ 300-4D	300	4.00 mm	4,027	2009075
40 AGMZ 400-4D	400	4.00 mm	4,568	2009076
40 AGMZ 500-4D	500	4.00 mm	5,108	2009077
40 AGMZ 600-4D	600	4.00 mm	5,649	2009078

H = YÜKSEKLİK = HEIGHT / W = GENİŞLİK = WIDTH / T = KALINLIK = THICKNESS

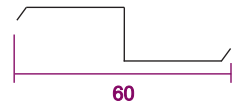
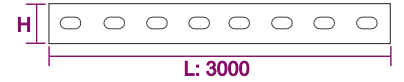

H50

Sipariş Kodu Order Code	W (mm)	T (mm)	Ağırlık (kg/m) Weight (kg/m)	Barkod Kodu Barcode Code
50 AGMZ 100-5D	100	5.00 mm	4,297	2009079
50 AGMZ 150-5D	150	5.00 mm	4,568	2009080
50 AGMZ 200-5D	200	5.00 mm	4,838	2009081
50 AGMZ 250-5D	250	5.00 mm	5,108	2009082
50 AGMZ 300-5D	300	5.00 mm	5,379	2009083
50 AGMZ 400-5D	400	5.00 mm	5,920	2009084
50 AGMZ 500-5D	500	5.00 mm	6,461	2009085
50 AGMZ 600-5D	600	5.00 mm	7,002	2009086

H = YÜKSEKLİK = HEIGHT / W = GENİŞLİK = WIDTH / T = KALINLIK = THICKNESS



H40 Yan kenara 40x4 mm Silme lama demir kullanılır.
H50 Yan kenara 50x5 mm Silme lama demir kullanılır.
H40 Side edge 40x4 mm wipe blade iron is used.
H50 Side edge 50x5 mm wipe blade iron is used.

TS 149 Elektro Galvaniz üretim de yapılmaktadır.
TS 149 Electro Galvanized production is also available.

- * Farklı kalınlık ve ölçülerde üretim yapılabılır.
- * Malzeme ağırlıkları yaklaşık değerlerdir, ± %10 değişiklik gösterebilir.
- * Malzeme kalınlık toleransı ± %10 dur.
- * Lütfen siparişlerinizde sipariş kodu veya ürün kodu ve Kaplama şeklini belirtiniz.

- * We can produce cable trays different thickness and dimensions
- * Cable trays are shown approximately weight, they could change ± %10 difference.
- * Cable trays thickness tolerances are shown ± %10 .
- * Please indicate order code and coating type in your orders.

AG SERIES

GEMİ TIPI KABLO MERDİVENİ 90° DÖNÜS

MARINE TYPE CABLE LADDER 90° BEND

SICAK DALDIRMA (SD)
HOT DIP GALVANIZED (SD)
TS EN ISO 1461



H40 Yan kenara 40x4 mm Silme lama demir kullanılır.
H50 Yan kenara 50x5 mm Silme lama demir kullanılır.
H40 Side edge 40x4 mm wipe blade iron is used.
H50 Side edge 50x5 mm wipe blade iron is used.

H40

Sipariş Kodu Order Code	W (mm)	T (mm)	Ağırlık (kg/ad) Weight (kg/ad)	Barkod Kodu Barcode Code
40 AGM 100Y	100	4.00 mm	1,085	2009121
40 AGM 150Y	150	4.00 mm	1,440	2009122
40 AGM 200Y	200	4.00 mm	1,796	2009123
40 AGM 250Y	250	4.00 mm	2,151	2009124
40 AGM 300Y	300	4.00 mm	2,506	2009125
40 AGM 400Y	400	4.00 mm	2,996	2009126
40 AGM 500Y	500	4.00 mm	3,484	2009127
40 AGM 600Y	600	4.00 mm	3,973	2009128

H = YÜKSEKLİK = HEIGHT / W = GENİŞLİK = WIDTH / T = KALINLIK = THICKNESS

H50

Sipariş Kodu Order Code	W (mm)	T (mm)	Ağırlık (kg/ad) Weight (kg/ad)	Barkod Kodu Barcode Code
50 AGM 100Y	100	5.00 mm	1,296	2009129
50 AGM 150Y	150	5.00 mm	1,707	2009130
50 AGM 200Y	200	5.00 mm	2,118	2009131
50 AGM 250Y	250	5.00 mm	2,529	2009132
50 AGM 300Y	300	5.00 mm	2,940	2009133
50 AGM 400Y	400	5.00 mm	3,483	2009134
50 AGM 500Y	500	5.00 mm	4,028	2009135
50 AGM 600Y	600	5.00 mm	4,572	2009136

H = YÜKSEKLİK = HEIGHT / W = GENİŞLİK = WIDTH / T = KALINLIK = THICKNESS

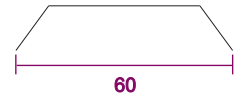
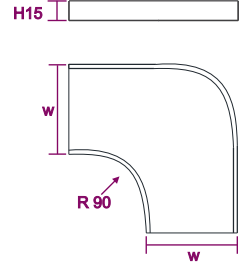

H40

Sipariş Kodu Order Code	W (mm)	T (mm)	Ağırlık (kg/ad) Weight (kg/ad)	Barkod Kodu Barcode Code
40 AGM 100YD	100	4.00 mm	1,031	2009137
40 AGM 150YD	150	4.00 mm	1,368	2009138
40 AGM 200YD	200	4.00 mm	1,706	2009139
40 AGM 250YD	250	4.00 mm	2,043	2009140
40 AGM 300YD	300	4.00 mm	2,381	2009141
40 AGM 400YD	400	4.00 mm	2,846	2009142
40 AGM 500YD	500	4.00 mm	3,310	2009143
40 AGM 600YD	600	4.00 mm	3,774	2009144

H = YÜKSEKLİK = HEIGHT / W = GENİŞLİK = WIDTH / T = KALINLIK = THICKNESS

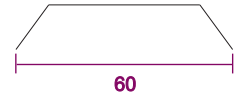
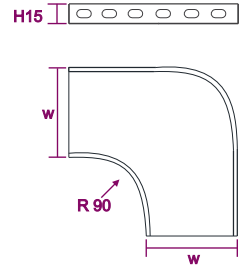

H50

Sipariş Kodu Order Code	W (mm)	T (mm)	Ağırlık (kg/ad) Weight (kg/ad)	Barkod Kodu Barcode Code
50 AGM 100YD	100	5.00 mm	1,231	2009145
50 AGM 150YD	150	5.00 mm	1,622	2009146
50 AGM 200YD	200	5.00 mm	2,012	2009147
50 AGM 250YD	250	5.00 mm	2,403	2009148
50 AGM 300YD	300	5.00 mm	2,793	2009149
50 AGM 400YD	400	5.00 mm	3,309	2009150
50 AGM 500YD	500	5.00 mm	3,827	2009151
50 AGM 600YD	600	5.00 mm	4,343	2009152

H = YÜKSEKLİK = HEIGHT / W = GENİŞLİK = WIDTH / T = KALINLIK = THICKNESS

ARTIM METAL ELEKTRİK A.Ş.

* Farklı kalınlık ve ölçülerde üretim yapılabılır.
* Malzeme ağırlıkları yaklaşık değerlerdir, \pm %10 değişiklik gösterebilir.
* Malzeme kalınlık toleransı \pm %10 dur.
* Lütfen siparişlerinizde sipariş kodu veya ürün kodu ve Kaplama şeklini belirtiniz.

* We can produce cable trays different thickness and dimensions
* Cable trays are shown approximately weight, they could change \pm %10 difference.
* Cable trays thickness tolerances are shown \pm %10 .
* Please indicate order code and coating type in your orders.

AG SERIES

GEMİ TIPI KABLO MERDİVENİ 90° DÖNÜS

MARINE TYPE CABLE LADDER 90° BEND

SICAK DALDIRMA (SD)

HOT DIP GALVANIZED (SD)

TS EN ISO 1461



H40 Yan kenara 40x4 mm Silme lama demir kullanılır.
H50 Yan kenara 50x5 mm Silme lama demir kullanılır.
H40 Side edge 40x4 mm wipe blade iron is used.
H50 Side edge 50x5 mm wipe blade iron is used.

H40

Sipariş Kodu Order Code	W (mm)	T (mm)	Ağırlık (kg/ad) Weight (kg/ad)	Barkod Kodu Barcode Code
40 AGMZ 100Y	100	4.00 mm	1,257	2009153
40 AGMZ 150Y	150	4.00 mm	1,708	2009154
40 AGMZ 200Y	200	4.00 mm	2,158	2009155
40 AGMZ 250Y	250	4.00 mm	2,609	2009156
40 AGMZ 300Y	300	4.00 mm	3,060	2009157
40 AGMZ 400Y	400	4.00 mm	3,739	2009158
40 AGMZ 500Y	500	4.00 mm	4,419	2009159
40 AGMZ 600Y	600	4.00 mm	5,099	2009160

H = YÜKSEKLİK = HEIGHT / W = GENİŞLİK = WIDTH / T = KALINLIK = THICKNESS

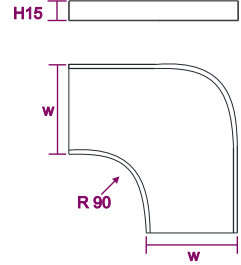

H50

Sipariş Kodu Order Code	W (mm)	T (mm)	Ağırlık (kg/ad) Weight (kg/ad)	Barkod Kodu Barcode Code
50 AGMZ 100Y	100	5.00 mm	1,467	2009161
50 AGMZ 150Y	150	5.00 mm	1,974	2009162
50 AGMZ 200Y	200	5.00 mm	2,480	2009163
50 AGMZ 250Y	250	5.00 mm	2,987	2009164
50 AGMZ 300Y	300	5.00 mm	3,492	2009165
50 AGMZ 400Y	400	5.00 mm	4,228	2009166
50 AGMZ 500Y	500	5.00 mm	4,963	2009167
50 AGMZ 600Y	600	5.00 mm	5,698	2009168

H = YÜKSEKLİK = HEIGHT / W = GENİŞLİK = WIDTH / T = KALINLIK = THICKNESS

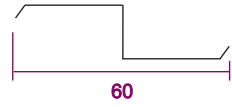

H40

Sipariş Kodu Order Code	W (mm)	T (mm)	Ağırlık (kg/ad) Weight (kg/ad)	Barkod Kodu Barcode Code
40 AGMZ 100YD	100	4.00 mm	1,194	2009169
40 AGMZ 150YD	150	4.00 mm	1,623	2009170
40 AGMZ 200YD	200	4.00 mm	2,050	2009171
40 AGMZ 250YD	250	4.00 mm	2,479	2009172
40 AGMZ 300YD	300	4.00 mm	2,907	2009173
40 AGMZ 400YD	400	4.00 mm	3,552	2009174
40 AGMZ 500YD	500	4.00 mm	4,198	2009175
40 AGMZ 600YD	600	4.00 mm	4,844	2009176

H = YÜKSEKLİK = HEIGHT / W = GENİŞLİK = WIDTH / T = KALINLIK = THICKNESS

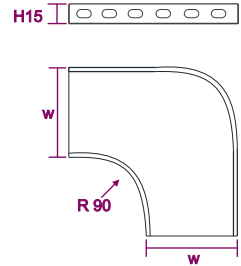

H40 Yan kenara 40x4 mm Silme lama demir kullanılır.
H50 Yan kenara 50x5 mm Silme lama demir kullanılır.
H40 Side edge 40x4 mm wipe blade iron is used.
H50 Side edge 50x5 mm wipe blade iron is used.

H50

Sipariş Kodu Order Code	W (mm)	T (mm)	Ağırlık (kg/ad) Weight (kg/ad)	Barkod Kodu Barcode Code
50 AGMZ 100YD	100	5.00 mm	1,394	2009177
50 AGMZ 150YD	150	5.00 mm	1,875	2009178
50 AGMZ 200YD	200	5.00 mm	2,356	2009179
50 AGMZ 250YD	250	5.00 mm	2,838	2009180
50 AGMZ 300YD	300	5.00 mm	3,317	2009181
50 AGMZ 400YD	400	5.00 mm	4,017	2009182
50 AGMZ 500YD	500	5.00 mm	4,715	2009183
50 AGMZ 600YD	600	5.00 mm	5,413	2009184

H = YÜKSEKLİK = HEIGHT / W = GENİŞLİK = WIDTH / T = KALINLIK = THICKNESS

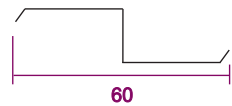

* Farklı kalınlık ve ölçülerde üretim yapılabılır.
* Malzeme ağırlıkları yaklaşık değerlerdir, ± %10 değişiklik gösterebilir.
* Malzeme kalınlık toleransı ± %10 dur.
* Lütfen siparişlerinizde sipariş kodu veya ürün kodu ve Kaplama şeklini belirtiniz.

* We can produce cable trays different thickness and dimensions
* Cable trays are shown approximately weight, they could change ± %10 difference.
* Cable trays thickness tolerances are shown ± %10 .
* Please indicate order code and coating type in your orders.

AG SERIES

GEMİ TIPI ASKI SİSTEMLERİ

MARINE TYPE SUPPORT SYSTEM

SICAK DALDIRMA (SD)
HOT DIP GALVANIZED (SD)
TS EN ISO 1461

KABLO MERDİVENİ EK PARÇASI / CABLE LADDERS STRAIGHT CONNECTORS

Sipariş Kodu Order Code	H (mm)	T (mm)	Ağırlık (kg/ad) Weight (kg/ad)	Barkod Kodu Barcode Code
40 AGM 01	40	4.00 mm	0,651	2009190
50 AGM 01	50	4.00 mm	0,763	2009191

H = YÜKSEKLİK = HEIGHT / T = KALINLIK = THICKNESS

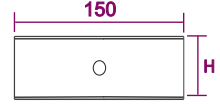

L ASKI AYAĞI / L HANGING SUPPORT

Sipariş Kodu Order Code	W (mm)	T (mm)	Ağırlık (kg/ad) Weight (kg/ad)	Barkod Kodu Barcode Code
AGLA 100	100	4.00 mm	0,145	2009201
AGLA 150	150	4.00 mm	0,197	2009202
AGLA 200	200	4.00 mm	0,249	2009203
AGLA 250	250	4.00 mm	0,300	2009204
AGLA 300	300	4.00 mm	0,352	2009205
AGLA 400	400	4.00 mm	0,456	2009206
AGLA 500	500	4.00 mm	0,560	2009207
AGLA 600	600	4.00 mm	0,663	2009208

W = GENİŞLİK = WIDTH / T = KALINLIK = THICKNESS

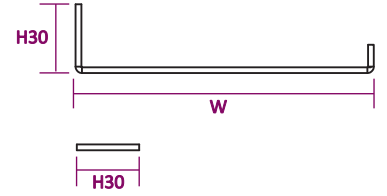

DELİKLİ L ASKI AYAĞI / PERFORATED L HANGING SUPPORT

Sipariş Kodu Order Code	W (mm)	T (mm)	Ağırlık (kg/ad) Weight (kg/ad)	Barkod Kodu Barcode Code
AGLAD 100	100	4.00 mm	0,133	2009209
AGLAD 150	150	4.00 mm	0,181	2009210
AGLAD 200	200	4.00 mm	0,229	2009211
AGLAD 250	250	4.00 mm	0,276	2009212
AGLAD 300	300	4.00 mm	0,324	2009213
AGLAD 400	400	4.00 mm	0,419	2009214
AGLAD 500	500	4.00 mm	0,515	2009215
AGLAD 600	600	4.00 mm	0,610	2009216

W = GENİŞLİK = WIDTH / T = KALINLIK = THICKNESS

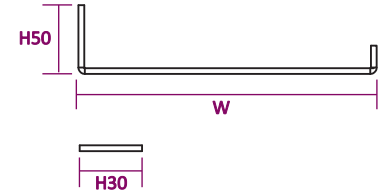

ARTIM METAL ELEKTRİK A.Ş.

* Farklı kalınlık ve ölçülerde üretim yapılabılır.
* Malzeme ağırlıkları yaklaşık değerlerdir, \pm %10 değişiklik gösterebilir.
* Malzeme kalınlık toleransı \pm %10 dur.
* Lütfen siparişlerinizde sipariş kodu veya ürün kodu ve Kaplama şeklini belirtiniz.

* We can produce cable trays different thickness and dimensions
* Cable trays are shown approximately weight, they could change \pm %10 difference.
* Cable trays thickness tolerances are shown \pm %10 .
* Please indicate order code and coating type in your orders.

AG SERIES

GEMİ TIPI ASKI SİSTEMLERİ

MARINE TYPE SUPPORT SYSTEM

SICAK DALDIRMA (SD)
HOT DIP GALVANIZED (SD)
TS EN ISO 1461



U KONSOL / U BRACKET

Sipariş Kodu Order Code	W (mm)	T (mm)	Ağırlık (kg/ad) Weight (kg/ad)	Barkod Kodu Barcode Code
AG UK 100	100	4.00 mm	0,176	2009251
AG UK 150	150	4.00 mm	0,228	2009252
AG UK 200	200	4.00 mm	0,280	2009253
AG UK 250	250	4.00 mm	0,332	2009254
AG UK 300	300	4.00 mm	0,383	2009255
AG UK 400	400	4.00 mm	0,487	2009256
AG UK 500	500	4.00 mm	0,591	2009257
AG UK 600	600	4.00 mm	0,694	2009258

W = GENİŞLİK = WIDTH / T = KALINLIK = THICKNESS

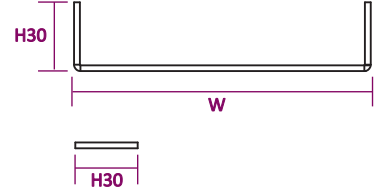

DELİKLİ U KONSOL / PERFORATED U BRACKET

Sipariş Kodu Order Code	W (mm)	T (mm)	Ağırlık (kg/ad) Weight (kg/ad)	Barkod Kodu Barcode Code
AG UKD 100	100	4.00 mm	0,162	2009259
AG UKD 150	150	4.00 mm	0,210	2009260
AG UKD 200	200	4.00 mm	0,257	2009261
AG UKD 250	250	4.00 mm	0,305	2009262
AG UKD 300	300	4.00 mm	0,353	2009263
AG UKD 400	400	4.00 mm	0,448	2009264
AG UKD 500	500	4.00 mm	0,543	2009265
AG UKD 600	600	4.00 mm	0,639	2009266

W = GENİŞLİK = WIDTH / T = KALINLIK = THICKNESS

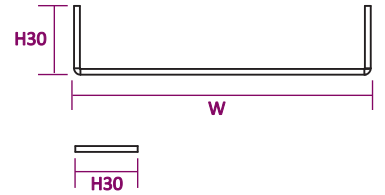

DELİKLİ UZUN U KONSOL / PERFORATED U LONG BRACKET

Sipariş Kodu Order Code	W (mm)	T (mm)	Ağırlık (kg/ad) Weight (kg/ad)	Barkod Kodu Barcode Code
AG UUKD 100	100	4.00 mm	0,238	2009267
AG UUKD 150	150	4.00 mm	0,290	2009268
AG UUKD 200	200	4.00 mm	0,342	2009269
AG UUKD 250	250	4.00 mm	0,394	2009270
AG UUKD 300	300	4.00 mm	0,446	2009271
AG UUKD 400	400	4.00 mm	0,549	2009272
AG UUKD 500	500	4.00 mm	0,653	2009273
AG UUKD 600	600	4.00 mm	0,756	2009274

W = GENİŞLİK = WIDTH / T = KALINLIK = THICKNESS

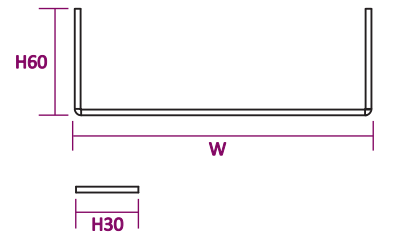

* Farklı kalınlık ve ölçülerde üretim yapılabılır.
* Malzeme ağırlıkları yaklaşık değerlerdir, ± %10 değişiklik gösterebilir.
* Malzeme kalınlık toleransı ± %10 dur.
* Lütfen siparişlerinizde sipariş kodu veya ürün kodu ve Kaplama şeklini belirtiniz.

* We can produce cable trays different thickness and dimensions
* Cable trays are shown approximately weight, they could change ± %10 difference.
* Cable trays thickness tolerances are shown ± %10 .
* Please indicate order code and coating type in your orders.

AG SERIES

GEMİ TIPI ASKI SİSTEMLERİ

MARINE TYPE SUPPORT SYSTEM

SICAK DALDIRMA (SD)
HOT DIP GALVANIZED (SD)
TS EN ISO 1461

F KONSOL / F BRACKET

Sipariş Kodu Order Code	W (mm)	T (mm)	Ağırlık (kg/ad) Weight (kg/ad)	Barkod Kodu Barcode Code
AG FK 100	100	4.00 mm	0,661	2009301
AG FK 150	150	4.00 mm	0,816	2009302
AG FK 200	200	4.00 mm	0,971	2009303
AG FK 250	250	4.00 mm	1,127	2009304
AG FK 300	300	4.00 mm	1,282	2009305
AG FK 400	400	4.00 mm	1,593	2009306
AG FK 500	500	4.00 mm	1,904	2009307
AG FK 600	600	4.00 mm	2,215	2009308

W = GENİŞLİK = WIDTH / T = KALINLIK = THICKNESS

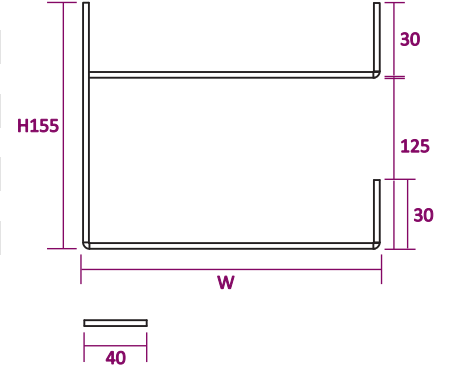

UZUN F KONSOL / F LONG BRACKET

Sipariş Kodu Order Code	W (mm)	T (mm)	Ağırlık (kg/ad) Weight (kg/ad)	Barkod Kodu Barcode Code
AG UFK 100	100	4.00 mm	0,878	2009309
AG UFK 150	150	4.00 mm	1,034	2009310
AG UFK 200	200	4.00 mm	1,189	2009311
AG UFK 250	250	4.00 mm	1,344	2009312
AG UFK 300	300	4.00 mm	1,500	2009313
AG UFK 400	400	4.00 mm	1,811	2009314
AG UFK 500	500	4.00 mm	2,122	2009315
AG UFK 600	600	4.00 mm	2,432	2009316

W = GENİŞLİK = WIDTH / T = KALINLIK = THICKNESS

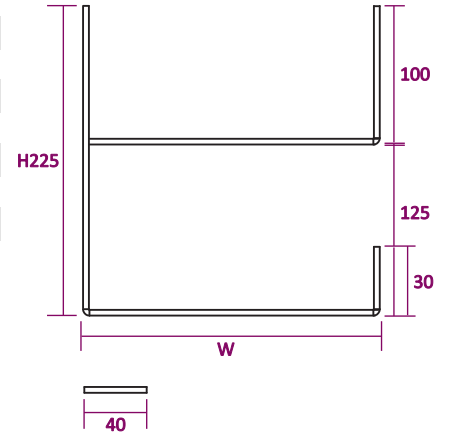

ARTIM METAL ELEKTRİK A.Ş.

* Farklı kalınlık ve ölçülerde üretim yapılabılır.
* Malzeme ağırlıkları yaklaşık değerlerdir, ± %10 değişiklik gösterebilir.
* Malzeme kalınlık toleransı ± %10 dur.
* Lütfen siparişlerinizde sipariş kodu veya ürün kodu ve Kaplama şeklini belirtiniz.

* We can produce cable trays different thickness and dimensions
* Cable trays are shown approximately weight, they could change ± %10 difference.
* Cable trays thickness tolerances are shown ± %10 .
* Please indicate order code and coating type in your orders.

AG SERIES

GEMİ TIPI ASKI SİSTEMLERİ

MARINE TYPE SUPPORT SYSTEM

SICAK DALDIRMA (SD)
HOT DIP GALVANIZED (SD)
TS EN ISO 1461



E KONSOL / E BRACKET

Sipariş Kodu Order Code	W (mm)	T (mm)	Ağırlık (kg/ad) Weight (kg/ad)	Barkod Kodu Barcode Code
AG EK 100	100	4.00 mm	1,337	2009351
AG EK 150	150	4.00 mm	1,648	2009352
AG EK 200	200	4.00 mm	1,958	2009353
AG EK 250	250	4.00 mm	2,269	2009354
AG EK 300	300	4.00 mm	2,580	2009355
AG EK 400	400	4.00 mm	3,202	2009356
AG EK 500	500	4.00 mm	3,824	2009357
AG EK 600	600	4.00 mm	4,445	2009358

W = GENİŞLİK = WIDTH / T = KALINLIK = THICKNESS

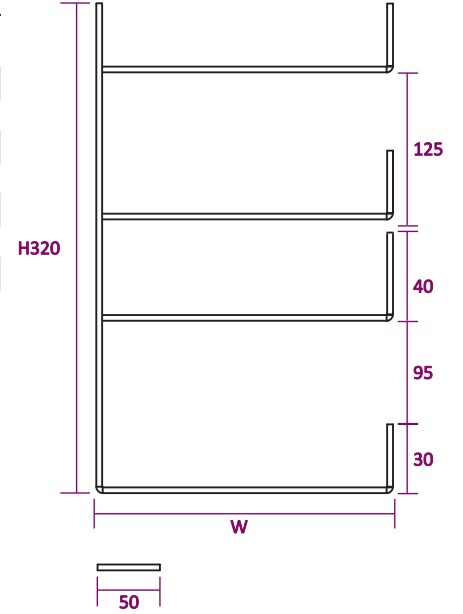

UZUN E KONSOL / E LONG BRACKET

Sipariş Kodu Order Code	W (mm)	T (mm)	Ağırlık (kg/ad) Weight (kg/ad)	Barkod Kodu Barcode Code
AG UEK 100	100	4.00 mm	1,556	2009359
AG UEK 150	150	4.00 mm	1,865	2009360
AG UEK 200	200	4.00 mm	2,176	2009361
AG UEK 250	250	4.00 mm	2,487	2009362
AG UEK 300	300	4.00 mm	2,798	2009363
AG UEK 400	400	4.00 mm	3,419	2009364
AG UEK 500	500	4.00 mm	4,041	2009365
AG UEK 600	600	4.00 mm	4,663	2009366

W = GENİŞLİK = WIDTH / T = KALINLIK = THICKNESS

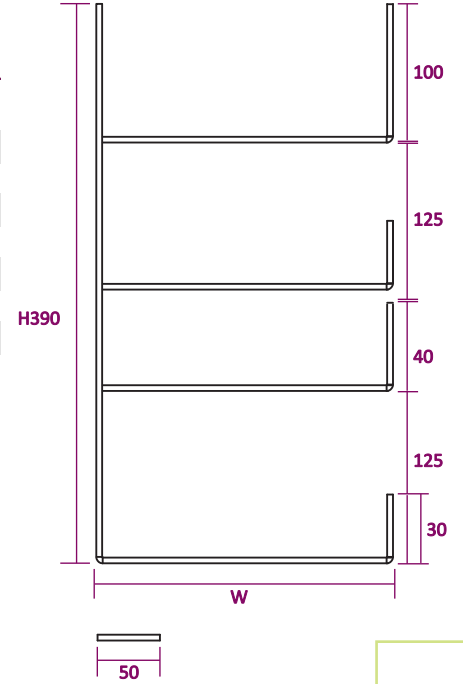

* Farklı kalınlık ve ölçülerde üretim yapılabılır.
* Malzeme ağırlıkları yaklaşık değerlerdir, \pm %10 değişiklik gösterebilir.
* Malzeme kalınlık toleransı \pm %10 dur.
* Lütfen siparişlerinizde sipariş kodu veya ürün kodu ve kaplama şeklini belirtiniz.

* We can produce cable trays different thickness and dimensions
* Cable trays are shown approximately weight, they could change \pm %10 difference.
* Cable trays thickness tolerances are shown \pm %10 .
* Please indicate order code and coating type in your orders.

AG SERIES

GEMİ TIPI ASKI SİSTEMLERİ

MARINE TYPE SUPPORT SYSTEM

SICAK DALDIRMA (SD)
HOT DIP GALVANIZED (SD)
TS EN ISO 1461



LAMBA AYAĞI / SUPPORT FOR LAMP

Sipariş Kodu Order Code	W (mm)	T (mm)	Ağırlık (kg/ad) Weight (kg/ad)	Barkod Kodu Barcode Code
AG LAA	60	4.00 mm	0,342	2009390

W = GENİŞLİK = WIDTH / T = KALINLIK = THICKNESS

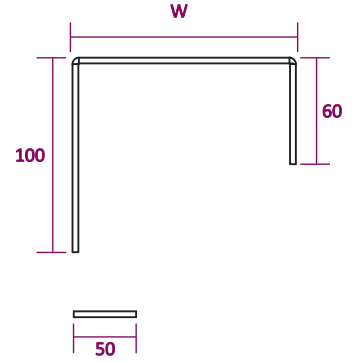

HARİCİ LAMBA AYAĞI / SUPPORT FOR EXTERNAL LAMP

Sipariş Kodu Order Code	W (mm)	T (mm)	Ağırlık (kg/ad) Weight (kg/ad)	Barkod Kodu Barcode Code
AG HLAA	100	4.00 mm	0,591	2009391

W = GENİŞLİK = WIDTH / T = KALINLIK = THICKNESS

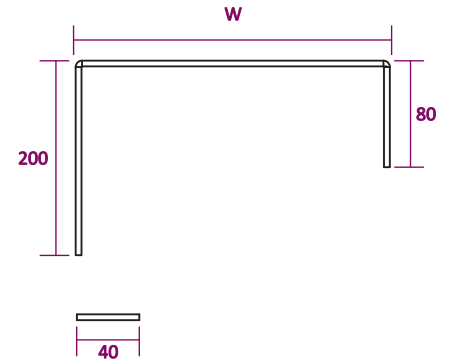

ARTIM METAL ELEKTRİK A.Ş.

* Farklı kalınlık ve ölçülerde üretim yapılabılır.
* Malzeme ağırlıkları yaklaşık değerlerdir, \pm %10 değişiklik gösterebilir.
* Malzeme kalınlık toleransı \pm %10 dur.
* Lütfen siparişlerinizde sipariş kodu veya ürün kodu ve Kaplama şeklini belirtiniz.

* We can produce cable trays different thickness and dimensions
* Cable trays are shown approximately weight, they could change \pm %10 difference.
* Cable trays thickness tolerances are shown \pm %10 .
* Please indicate order code and coating type in your orders.

art

POWER CARRYING SOLUTIONS



BORU SİSTEMLERİ

PIPE SYSTEMS



EMT SERIES

BORU SİSTEMLERİ

PIPE SYSTEMS

PVC KAPLI ÇELİK SİRAL BORU / PVC COATED STEEL SİRAL

Sipariş Kodu	Ebat	İç Çap Inner	Dış Çap Outer	Paket Miktarı (m)	Barkod Kodu
Order Code	Size	Diamete	Diamete	Package Content (m)	Barcode Code
ART PCS 10	1/4 "	Q 10	Q 15	50	2004601
ART PCS 13	3/8 "	Q 13	Q 18	50	2004602
ART PCS 16	1/2 "	Q 16	Q 22	50	2004603
ART PCS 21	3/4 "	Q 21	Q 27	50	2004604
ART PCS 26	1 "	Q 26	Q 34	25	2004605
ART PCS 36	1 1/4 "	Q 36	Q 44	25	2004606
ART PCS 40	1 1/2 "	Q 40	Q 47	25	2004607
ART PCS 51	2 "	Q 51	Q 59	25	2004608
ART PCS 63	2 1/2 "	Q 63	Q 72	25	2004609
ART PCS 78	3 "	Q 78	Q 88	15	2004610
ART PCS 102	4 "	Q 102	Q 112	10	2004611

Hammedde: Galvaniz Çelik ve PVC
Montaj Sıcaklığı: -25°C / +90°C
Standart renk Siyah, istenilen özel imalat da yapılabilir.

Material: Galvanized Steel and PVC
Installation Temperature: -25°C / +90°C
Standard color Black can be made in any special production.

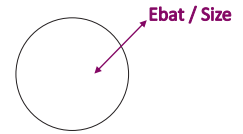

ÇELİK SİRAL BORU / STEEL SİRAL

Sipariş Kodu	Ebat	İç Çap Inner	Dış Çap Outer	Paket Miktarı (m)	Barkod Kodu
Order Code	Size	Diamete	Diamete	Package Content (m)	Barcode Code
ART CS 10	1/4 "	Q 10	Q 13	50	2004612
ART CS 13	3/8 "	Q 13	Q 16	50	2004613
ART CS 16	1/2 "	Q 16	Q 20	50	2004614
ART CS 21	3/4 "	Q 21	Q 25	50	2004615
ART CS 26	1 "	Q 26	Q 30	25	2004616
ART CS 36	1 1/4 "	Q 36	Q 39	25	2004617
ART CS 40	1 1/2 "	Q 40	Q 44	25	2004618
ART CS 51	2 "	Q 51	Q 55	25	2004619
ART CS 63	2 1/2 "	Q 63	Q 71	25	2004620
ART CS 78	3 "	Q 78	Q 86	15	2004621
ART CS 102	4 "	Q 102	Q 109	10	2004622

Hammedde: Galvaniz Çelik
Montaj Sıcaklığı: -25°C / +90°C
Standart renk.

Material: Galvanized Steel
Installation Temperature: -25°C / +90°C
Standard color.

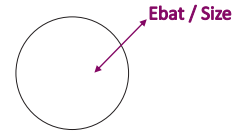

KLAVUZ TELLİ ÇELİK SİRAL BORU / STEEL WITH INTERNAL WIRE SİRAL

Sipariş Kodu	Ebat	İç Çap Inner	Dış Çap Outer	Paket Miktarı (m)	Barkod Kodu
Order Code	Size	Diamete	Diamete	Package Content (m)	Barcode Code
ART KTCS 10	1/4 "	Q 10	Q 13	50	2004623
ART KTCS 13	3/8 "	Q 13	Q 16	50	2004624
ART KTCS 16	1/2 "	Q 16	Q 20	50	2004625
ART KTCS 21	3/4 "	Q 21	Q 25	50	2004626
ART KTCS 26	1 "	Q 26	Q 30	25	2004627
ART KTCS 36	1 1/4 "	Q 36	Q 39	25	2004628
ART KTCS 40	1 1/2 "	Q 40	Q 44	25	2004629
ART KTCS 51	2 "	Q 51	Q 55	25	2004630

Hammedde: Galvaniz Çelik ve PVC
Montaj Sıcaklığı: -25°C / +90°C
Standart renk Siyah, istenilen özel imalat da yapılabilir.

Material: Galvanized Steel and PVC
Installation Temperature: -25°C / +90°C
Standard color Black can be made in any special production.

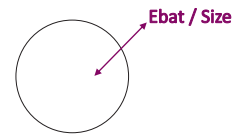

Kod yanına "P" ilave ediniz.
Add "P" next to the code.

ARTİM METAL ELEKTRİK A.Ş.

- * Farklı kalınlık ve ölçülerde üretim yapılabılır.
- * Malzeme ağırlıkları yaklaşık değerlerdir, \pm %10 değişiklik gösterebilir.
- * Malzeme kalınlık toleransı \pm %10 dur.
- * Lütfen siparişlerinizde sipariş kodu veya ürün kodu ve Kaplama şeklini belirtiniz.

- * We can produce cable trays different thickness and dimensions
- * Cable trays are shown approximately weight, they could change \pm %10 difference.
- * Cable trays thickness tolerances are shown \pm %10 .
- * Please indicate order code and coating type in your orders.

EMT SERIES BORU SİSTEMLERİ PIPE SYSTEMS

PREGALVANİZ (PG)
PREGALVANIZED (PG)
TS EN 10346

EMT DİŞSİZ GALVANİZLİ ÇELİK BORU / EMT UNTHREADED GALVANIZED PIPE

Sipariş Kodu	Ebat	İç Çap İnner	T	Ağırlık (kg/m)	Paket Miktarı (m)	Barkod Kodu
Order Code	Size	Diamete	(mm)	Weight (kg/m)	Package Content (m)	Barcode Code
ART EMT 050	1/2 "	Q 16	1,07	0,440	30,50	2004651
ART EMT 075	3/4 "	Q 21	1,25	0,68	30,50	2004652
ART EMT 100	1 "	Q 26	1,45	1,00	30,50	2004653
ART EMT 125	1 1/4 "	Q 35	1,65	1,49	15,25	2004654
ART EMT 150	1 1/2 "	Q 41	1,65	1,73	15,25	2004655
ART EMT 200	2 "	Q 52	1,65	2,20	9,15	2004656
ART EMT 250	2 1/2 "	Q 69	1,83	3,07	9,15	2004657
ART EMT 300	3 "	Q 85	1,83	3,87	6,10	2004658
ART EMT 400	4 "	Q 110	2,11	5,81	6,10	2004659

Hammadde: Galvaniz Çelik
Montaj Sıcaklığı: -25°C / + 90°C
Standart uzunluk L:3050 mm

Material: Galvanized Steel
Installation Temperature: -25°C / +90°C
Standard Length L:3050 mm

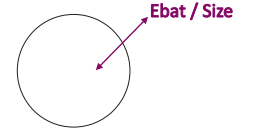

IMC DİŞLİ GALVANİZLİ ÇELİK BORU / IMC THREADED GALVANIZED PIPE

Sipariş Kodu	Ebat	İç Çap İnner	T	Ağırlık (kg/m)	Paket Miktarı (m)	Barkod Kodu
Order Code	Size	Diamete	(mm)	Weight (kg/m)	Package Content (m)	Barcode Code
ART IMC 050	1/2 "	Q 16	1,97	0,920	30,50	2004660
ART IMC 075	3/4 "	Q 22	2,10	1,25	30,50	2004661
ART IMC 100	1 "	Q 28	2,35	1,77	15,25	2004662
ART IMC 125	1 1/4 "	Q 36	2,42	2,35	9,15	2004663
ART IMC 150	1 1/2 "	Q 42	2,54	2,89	9,15	2004664
ART IMC 200	2 "	Q 54	2,67	3,81	9,15	2004665
ART IMC 250	2 1/2 "	Q 65	3,81	6,57	6,10	2004666
ART IMC 300	3 "	Q 80	3,81	8,08	6,10	2004667
ART IMC 400	4 "	Q 105	3,81	10,42	3,05	2004668

Hammadde: Galvaniz Çelik
Montaj Sıcaklığı: -25°C / + 90°C
Standart uzunluk L:3050 mm

Material: Galvanized Steel
Installation Temperature: -25°C / +90°C
Standard Length L:3050 mm

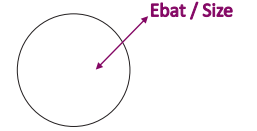

RSC DİŞLİ GALVANİZLİ ÇELİK BORU / RSC THREADED GALVANIZED PIPE

Sipariş Kodu	Ebat	İç Çap İnner	T	Ağırlık (kg/m)	Paket Miktarı (m)	Barkod Kodu
Order Code	Size	Diamete	(mm)	Weight (kg/m)	Package Content (m)	Barcode Code
ART RSC 050	1/2 "	Q 16	2,64	1,100	30,50	2004669
ART RSC 075	3/4 "	Q 21	2,72	1,40	30,50	2004670
ART RSC 100	1 "	Q 27	3,20	2,20	15,25	2004671
ART RSC 125	1 1/4 "	Q 35	3,38	3,10	15,25	2004672
ART RSC 150	1 1/2 "	Q 41	3,51	3,60	15,25	2004673
ART RSC 200	2 "	Q 53	3,71	4,90	9,15	2004674
ART RSC 250	2 1/2 "	Q 63	4,90	7,60	9,15	2004675
ART RSC 300	3 "	Q 78	5,21	9,80	6,10	2004676
ART RSC 400	4 "	Q 103	5,72	14,10	6,10	2004677
ART RSC 500	5 "	Q 129	6,22	19,00	3,05	2004678
ART RSC 600	6 "	Q 155	6,76	24,90	3,05	2004679

Hammadde: Galvaniz Çelik
Montaj Sıcaklığı: -25°C / + 90°C
Standart uzunluk L:3050 mm

Material: Galvanized Steel
Installation Temperature: -25°C / +90°C
Standard Length L:3050 mm

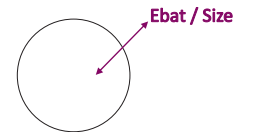

* Farklı kalınlık ve ölçülerde üretim yapılabılır.
* Malzeme ağırlıkları yaklaşık değerlerdir, ± %10 değişiklik gösterebilir.
* Malzeme kalınlık toleransı ± %10 dur.
* Lütfen siparişlerinizde sipariş kodu veya ürün kodu ve kaplama şeklini belirtiniz.

* We can produce cable trays different thickness and dimensions
* Cable trays are shown approximately weight, they could change ± %10 difference.
* Cable trays thickness tolerances are shown ± %10 .
* Please indicate order code and coating type in your orders.

EMT SERIES

BORU SİSTEMLERİ

PIPE SYSTEMS

PREGALVANIZ (PG)
PREGALVANIZED (PG)
TS EN 10346



VİDALI TİP BİRLEŞTİRME MUFU / SET SCREW TYPE COUPLING

Sipariş Kodu	Ebat	İç Çap Inner	Ağırlık (kg/ad)	Paket Miktarı (Ad)	Barkod Kodu
Order Code	Size	Diameter	Weight (kg/pcs)	Package Content (Pcs)	Barcode Code
ART VBM 01	1/2 "	Q 22	0,038	50	2004751
ART VBM 02	3/4 "	Q 27	0,054	25	2004752
ART VBM 03	1 "	Q 34	0,083	20	2004753
ART VBM 04	1 1/4 "	Q 44	0,168	25	2004754
ART VBM 05	1 1/2 "	Q 47	0,188	25	2004755
ART VBM 06	2 "	Q 59	0,260	20	2004756
ART VBM 07	2 1/2 "	Q 72	0,583	12	2004757
ART VBM 08	3 "	Q 88	0,750	12	2004758
ART VBM 09	4 "	Q 112	1,067	6	2004759

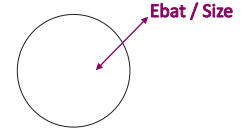

SIKMALI TİP BİRLEŞTİRME MUFU / COMPRESSION TYPE COUPLING

Sipariş Kodu	Ebat	İç Çap Inner Diameter	Ağırlık (kg/ad)	Paket Miktarı (Ad)	Barkod Kodu
Order Code	Size	Inner Diameter	Weight (kg/pcs)	Package Content (Pcs)	Barcode Code
ART SBM 01	1/2 "	Q 22	0,068	25	2004760
ART SBM 02	3/4 "	Q 27	0,092	25	2004761
ART SBM 03	1 "	Q 34	0,143	10	2004762
ART SBM 04	1 1/4 "	Q 44	0,188	25	2004763
ART SBM 05	1 1/2 "	Q 47	0,290	20	2004764
ART SBM 06	2 "	Q 59	0,313	15	2004765
ART SBM 07	2 1/2 "	Q 72	0,875	8	2004766
ART SBM 08	3 "	Q 88	1,050	4	2004767
ART SBM 09	4 "	Q 112	1,525	4	2004768

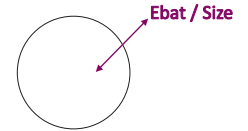

ARTIM METAL ELEKTRİK A.Ş.

* Farklı kalınlık ve ölçülerde üretim yapılabılır.
* Malzeme ağırlıkları yaklaşık değerlerdir, \pm %10 değişiklik gösterebilir.
* Malzeme kalınlık toleransı \pm %10 dur.
* Lütfen siparişlerinizde sipariş kodu veya ürün kodu ve kaplama şeklini belirtiniz.

* We can produce cable trays different thickness and dimensions
* Cable trays are shown approximately weight, they could change \pm %10 difference.
* Cable trays thickness tolerances are shown \pm %10 .
* Please indicate order code and coating type in your orders.

EMT SERIES BORU SİSTEMLERİ PIPE SYSTEMS

PREGALVANİZ (PG)
PREGALVANIZED (PG)
TS EN 10346



90° DİŞSİZ DİRSEK / 90° UNTHREADED ELBOW

Sipariş Kodu	Ebat	İç Çap İnner	Ağırlık (kg/ad)	Paket Miktarı (Ad)	Barkod Kodu
Order Code	Size	Diamete	Weight (kg/pcs)	Package Content (Pcs)	Barcode Code
ART TTE 01	1/2 "	Q 22	0,106	100	2004769
ART TTE 02	3/4 "	Q 27	0,175	100	2004770
ART TTE 03	1 "	Q 34	0,350	50	2004771
ART TTE 04	1 1/4 "	Q 44	0,700	40	2004772
ART TTE 05	1 1/2 "	Q 47	0,812	40	2004773
ART TTE 06	2 "	Q 59	0,900	15	2004774
ART TTE 07	2 1/2 "	Q 72	2,000	10	2004775
ART TTE 08	3 "	Q 88	2,722	9	2004776
ART TTE 09	4 "	Q 112	4,778	9	2004777

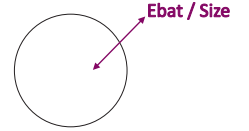

90° DİŞLİ DİRSEK / 90° THREADED ELBOW

Sipariş Kodu	Ebat	İç Çap İnner	Ağırlık (kg/ad)	Paket Miktarı (Ad)	Barkod Kodu
Order Code	Size	Diamete	Weight (kg/pcs)	Package Content (Pcs)	Barcode Code
ART TRE 01	1/2 "	Q 22	0,200	100	2004778
ART TRE 02	3/4 "	Q 27	0,320	50	2004779
ART TRE 03	1 "	Q 34	0,550	40	2004780
ART TRE 04	1 1/4 "	Q 44	0,867	30	2004781
ART TRE 05	1 1/2 "	Q 47	1,300	20	2004782
ART TRE 06	2 "	Q 59	2,250	8	2004783
ART TRE 07	2 1/2 "	Q 72	1,375	4	2004784
ART TRE 08	3 "	Q 88	4,300	2	2004785
ART TRE 09	4 "	Q 112	15,000	1	2004786
ART TRE 10	5 "	Q 139	15,700	1	2004787
ART TRE 11	6 "	Q 165	16,400	1	2004788

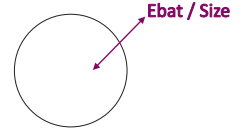

* Farklı kalınlık ve ölçülerde üretim yapıla bilinir.
* Malzeme ağırlıkları yaklaşık değerlerdir, \pm %10 değişiklik gösterebilir.
* Malzeme kalınlık toleransı \pm %10 dur.
* Lütfen siparişlerinizde sipariş kodu veya ürün kodu ve Kaplama şeklini belirtiniz.

* We can produce cable trays different thickness and dimensions
* Cable trays are shown approximately weight, they could change \pm %10 difference.
* Cable trays thickness tolerances are shown \pm %10 .
* Please indicate order code and coating type in your orders.

EMT SERIES

BORU SİSTEMLERİ

PIPE SYSTEMS

PREGALVANİZ (PG)

PREGALVANIZED (PG)

TS EN 10346

45° DİŞSİZ DİRSEK / 45° UNTHREADED ELBOW

Sipariş Kodu	Ebat	İç Çap İnner	Ağırlık (kg/ad)	Paket Miktarı (Ad)	Barkod Kodu
Order Code	Size	Diamete	Weight (kg/pcs)	Package Content (Pcs)	Barcode Code
ART TTE 01 (45°)	1/2 "	Q 22	0,100	200	2004789
ART TTE 02 (45°)	3/4 "	Q 27	0,120	100	2004790
ART TTE 03 (45°)	1 "	Q 34	0,320	50	2004791
ART TTE 04 (45°)	1 1/4 "	Q 44	0,560	25	2004792
ART TTE 05 (45°)	1 1/2 "	Q 47	0,800	20	2004793
ART TTE 06 (45°)	2 "	Q 59	1,200	15	2004794
ART TTE 07 (45°)	2 1/2 "	Q 72	2,000	10	2004795
ART TTE 08 (45°)	3 "	Q 88	2,722	9	2004796
ART TTE 09 (45°)	4 "	Q 112	4,777	9	2004797

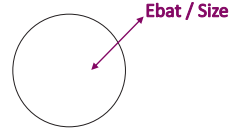

45° DİŞLİ DİRSEK / 45° THREADED ELBOW

Sipariş Kodu	Ebat	İç Çap İnner	Ağırlık (kg/ad)	Paket Miktarı (Ad)	Barkod Kodu
Order Code	Size	Diamete	Weight (kg/pcs)	Package Content (Pcs)	Barcode Code
ART TRE 01 (45°)	1/2 "	Q 22	0,200	100	2004798
ART TRE 02 (45°)	3/4 "	Q 27	0,320	50	2004799
ART TRE 03 (45°)	1 "	Q 34	0,550	40	2004800
ART TRE 04 (45°)	1 1/4 "	Q 44	0,867	30	2004801
ART TRE 05 (45°)	1 1/2 "	Q 47	1,300	20	2004802
ART TRE 06 (45°)	2 "	Q 59	2,250	8	2004803
ART TRE 07 (45°)	2 1/2 "	Q 72	1,375	4	2004804
ART TRE 08 (45°)	3 "	Q 88	4,300	2	2004805
ART TRE 09 (45°)	4 "	Q 112	15,000	1	2004806
ART TRE 10 (45°)	5 "	Q 139	15,700	1	2004807
ART TRE 11 (45°)	6 "	Q 165	16,400	1	2004808

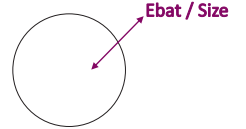

ARTIM METAL ELEKTRİK A.Ş.

* Farklı kalınlık ve ölçülerde üretim yapılabılır.
* Malzeme ağırlıkları yaklaşık değerlerdir, ± %10 değişiklik gösterebilir.
* Malzeme kalınlık toleransı ± %10 dur.
* Lütfen siparişlerinizde sipariş kodu veya ürün kodu ve Kaplama şeklini belirtiniz.

* We can produce cable trays different thickness and dimensions
* Cable trays are shown approximately weight, they could change ± %10 difference.
* Cable trays thickness tolerances are shown ± %10 .
* Please indicate order code and coating type in your orders.

EMT SERIES BORU SİSTEMLERİ PIPE SYSTEMS

PREGALVANİZ (PG)
PREGALVANİZED (PG)
TS EN 10346

VİDALI TİP SONLANDIRMA RAKORU / SCREW TYPE ENDING CONNECTOR



Sipariş Kodu Order Code	Ebat Size	İç Çap İnner Diamete	Ağırlık (kg/ad) Weight (kg/pcs)	Paket Miktarı (Ad) Package Content (Pcs)	Barkod Kodu Barcode Code
ART L 121 ST	1/2 "	Q 22	0,042	50	2004809
ART L 123 ST	3/4 "	Q 27	0,060	25	2004810
ART L 125 ST	1 "	Q 34	0,095	20	2004811
ART L 127 ST	1 1/4 "	Q 44	0,164	25	2004812
ART L 129 ST	1 1/2 "	Q 47	0,180	25	2004813
ART L 131 ST	2 "	Q 59	0,235	20	2004814
ART L 133 ST	2 1/2 "	Q 72	0,333	12	2004815
ART L 135 ST	3 "	Q 88	0,400	12	2004816
ART L 139 ST	4 "	Q 112	0,550	6	2004817

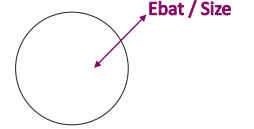

EMT BORU ENTÜLÜ (ŞEFFAF) / PVC PIPE CAPS (TRANSPARENT)



Sipariş Kodu Order Code	Ebat Size	İç Çap İnner Diamete	Ağırlık (kg/ad) Weight (kg/pcs)	Paket Miktarı (Ad) Package Content (Pcs)	Barkod Kodu Barcode Code
ART SFF 01	1/2 "	Q 22	-	100	2004818
ART SFF 02	3/4 "	Q 27	-	100	2004819
ART SFF 03	1 "	Q 34	-	100	2004820
ART SFF 04	1 1/4 "	Q 44	-	50	2004821
ART SFF 05	1 1/2 "	Q 47	-	50	2004822
ART SFF 06	2 "	Q 59	-	25	2004823
ART SFF 07	2 1/2 "	Q 72	-	20	2004824
ART SFF 08	3 "	Q 88	-	20	2004825
ART SFF 09	4 "	Q 112	-	10	2004826

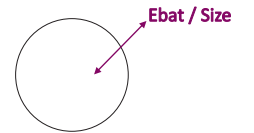

* Farklı kalınlık ve ölçülerde üretim yapıla bilinir.
* Malzeme ağırlıkları yaklaşık değerlerdir, \pm %10 değişiklik gösterebilir.
* Malzeme kalınlık toleransı \pm %10 dur.
* Lütfen siparişlerinizde sipariş kodu veya ürün kodu ve Kaplama şeklini belirtiniz.

* We can produce cable trays different thickness and dimensions
* Cable trays are shown approximately weight, they could change \pm %10 difference.
* Cable trays thickness tolerances are shown \pm %10 .
* Please indicate order code and coating type in your orders.

EMT SERIES

BORU SİSTEMLERİ

PIPE SYSTEMS

PREGALVANIZ (PG)

PREGALVANIZED (PG)

TS EN 10346



ÇİFT DELİKLİ BORU TESPİT KROŞESİ / TWO HOLE

STEEL STRAP

Sipariş Kodu	Ebat	İç Çap İnner Diamete	Paket Miktarı (Ad)	Barkod Kodu
Order Code	Size	Diamete	Package Content (Pcs)	Barcode Code
ART CTK 01	1/2 "	Q 22	100	2004701
ART CTK 02	3/4 "	Q 27	100	2004702
ART CTK 03	1 "	Q 34	50	2004703
ART CTK 04	1 1/4 "	Q 44	50	2004704
ART CTK 05	1 1/2 "	Q 47	25	2004705
ART CTK 06	2 "	Q 59	20	2004706
ART CTK 07	2 1/2 "	Q 72	10	2004707
ART CTK 08	3 "	Q 88	10	2004708
ART CTK 09	4 "	Q 112	10	2004709
ART CTK 10	5 "	Q 139	10	2004710
ART CTK 11	6 "	Q 165	10	2004711

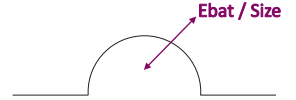

TEK DELİKLİ BORU TESPİT KROŞESİ / ONE HOLE

STEEL STRAP

Sipariş Kodu	Ebat	İç Çap İnner Diamete	Paket Miktarı (Ad)	Barkod Kodu
Order Code	Size	Diamete	Package Content (Pcs)	Barcode Code
ART TTK 01	1/2 "	Q 22	200	2004712
ART TTK 02	3/4 "	Q 27	200	2004713
ART TTK 03	1 "	Q 34	100	2004714
ART TTK 04	1 1/4 "	Q 44	50	2004715
ART TTK 05	1 1/2 "	Q 47	50	2004716
ART TTK 06	2 "	Q 59	25	2004717
ART TTK 07	2 1/2 "	Q 72	10	2004718
ART TTK 08	3 "	Q 88	10	2004719
ART TTK 09	4 "	Q 112	10	2004720
ART TTK 10	5 "	Q 139	10	2004721
ART TTK 11	6 "	Q 165	10	2004722

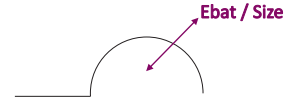

ARTIM METAL ELEKTRİK A.Ş.

- * Farklı kalınlık ve ölçülerde üretim yapılabılır.
- * Malzeme ağırlıkları yaklaşık değerlerdir, \pm %10 değişiklik gösterebilir.
- * Malzeme kalınlık toleransı \pm %10 dur.
- * Lütfen siparişlerinizde sipariş kodu veya ürün kodu ve kaplama şeklini belirtiniz.

- * We can produce cable trays different thickness and dimensions
- * Cable trays are shown approximately weight, they could change \pm %10 difference.
- * Cable trays thickness tolerances are shown \pm %10 .
- * Please indicate order code and coating type in your orders.

EMT SERIES BORU SİSTEMLERİ PIPE SYSTEMS

PREGALVANİZ (PG)
PREGALVANIZED (PG)
TS EN 10346



BORU ASMA KELEPÇESİ / CONDUIT HANGER WITH BOLTS

Sipariş Kodu Order Code	Ebat Size	İç Çap İnner Diamete	Paket Miktarı (Ad) Package Content (Pcs)	Barkod Kodu Barcode Code
ART WBA 01	1/2 "	Q 22	400	2004723
ART WBA 02	3/4 "	Q 27	300	2004724
ART WBA 03	1 "	Q 34	200	2004725
ART WBA 04	1 1/4 "	Q 44	150	2004726
ART WBA 05	1 1/2 "	Q 47	100	2004727
ART WBA 06	2 "	Q 59	75	2004728
ART WBA 07	2 1/2 "	Q 72	50	2004729
ART WBA 08	3 "	Q 88	50	2004730
ART WBA 09	4 "	Q 112	25	2004731

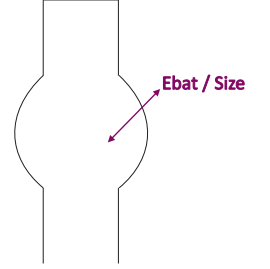

RAY TİPİ KELEPÇE / RAIL TYPE CLAMP

Sipariş Kodu Order Code	Ebat Size	İç Çap İnner Diamete	Paket Miktarı (Ad) Package Content (Pcs)	Barkod Kodu Barcode Code
ART GH 01	1/2 "	Q 22	300	2004732
ART GH 02	3/4 "	Q 27	300	2004733
ART GH 03	1 "	Q 34	250	2004734
ART GH 04	1 1/4 "	Q 44	200	2004735
ART GH 05	1 1/2 "	Q 47	150	2004736
ART GH 06	2 "	Q 59	150	2004737
ART GH 07	2 1/2 "	Q 72	100	2004738
ART GH 08	3 "	Q 88	100	2004739
ART GH 09	4 "	Q 112	50	2004740

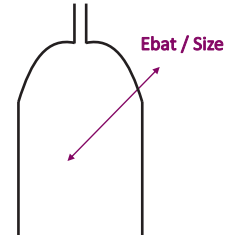

* Farklı kalınlık ve ölçülerde üretim yapılabılır.
* Malzeme ağırlıkları yaklaşık değerlerdir, \pm %10 değişiklik gösterebilir.
* Malzeme kalınlık toleransı \pm %10 dur.
* Lütfen siparişlerinizde sipariş kodu veya ürün kodu ve kaplama şeklini belirtiniz.

* We can produce cable trays different thickness and dimensions
* Cable trays are shown approximately weight, they could change \pm %10 difference.
* Cable trays thickness tolerances are shown \pm %10 .
* Please indicate order code and coating type in your orders.

EMT SERIES

BORU SİSTEMLERİ

PIPE SYSTEMS

PREGALVANİZ (PG)
PREGALVANIZED (PG)
TS EN 10346



U BOLT / U BOLT

Sipariş Kodu	Ebat	İç Çap Inner	Metric	Diş boy Tooth Length	L (mm) Length (mm)	Ağırlık (kg/ad) Weight (kg/pcs)	Barkod Kodu Barcode Code
Order Code	Size	Diamete	(mm)	(mm)	(mm)	(kg/pcs)	Barcode Code
ART UB 01	1/2 "	Q 22	M6	22	40	0,018	2004851
ART UB 02	3/4 "	Q 27	M6	30	50	0,040	2004852
ART UB 03	1 "	Q 34	M8	30	55	0,042	2004853
ART UB 04	1 1/4 "	Q 44	M8	35	68	0,055	2004854
ART UB 05	1 1/2 "	Q 47	M8	35	70	0,060	2004855
ART UB 06	2 "	Q 59	M10	35	80	0,066	2004856
ART UB 07	2 1/2 "	Q 72	M10	45	110	0,087	2004857
ART UB 08	3 "	Q 88	M12	45	115	0,150	2004858
ART UB 09	4 "	Q 112	M12	55	156	0,200	2004859

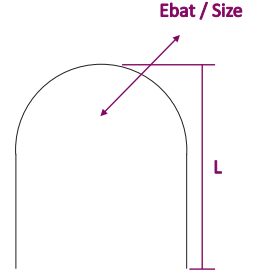

KARE BOLT / SQUARE BOLT

Sipariş Kodu	Ebat	İç Çap Inner	Metric	Diş boy Tooth Length	L (mm) Length (mm)	Ağırlık (kg/ad) Weight (kg/pcs)	Barkod Kodu Barcode Code
Order Code	Size	Diamete	(mm)	(mm)	(mm)	(kg/pcs)	Barcode Code
ART KB 01	1/2 "	Q 22	M6	22	40	0,018	2004860
ART KB 02	3/4 "	Q 27	M6	30	50	0,040	2004861
ART KB 03	1 "	Q 34	M8	30	55	0,042	2004862
ART KB 04	1 1/4 "	Q 44	M8	35	68	0,055	2004863
ART KB 05	1 1/2 "	Q 47	M8	35	70	0,060	2004864
ART KB 06	2 "	Q 59	M10	35	80	0,066	2004865
ART KB 07	2 1/2 "	Q 72	M10	45	110	0,087	2004866
ART KB 08	3 "	Q 88	M12	45	115	0,150	2004867
ART KB 09	4 "	Q 112	M12	55	156	0,200	2004868

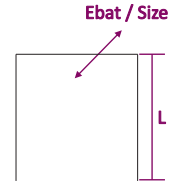

ARTIM METAL ELEKTRİK A.Ş.

* Farklı kalınlık ve ölçülerde üretim yapılabılır.
* Malzeme ağırlıkları yaklaşık değerlerdir, \pm %10 değişiklik gösterebilir.
* Malzeme kalınlık toleransı \pm %10 dur.
* Lütfen siparişlerinizde sipariş kodu veya ürün kodu ve Kaplama şeklini belirtiniz.

* We can produce cable trays different thickness and dimensions
* Cable trays are shown approximately weight, they could change \pm %10 difference.
* Cable trays thickness tolerances are shown \pm %10 .
* Please indicate order code and coating type in your orders.

EMT SERIES BORU SİSTEMLERİ PIPE SYSTEMS

PREGALVANİZ (PG)
PREGALVANIZED (PG)
TS EN 10346

LASTİKLİ SOMUNLU BORU KELEPÇESİ / PIPE CLAMP WITH RUBBER & NUT



Sipariş Kodu Order Code	Ebat Size	Sıkma Aralığı Clamping Range (mm)	Metric (mm)	Paket Miktarı (Ad) Package Content (Pcs)	Barkod Kodu Barcode Code
ART SBK 01	1/2 "	20-23	M8	300	2004869
ART SBK 02	3/4 "	25-28	M8	250	2004870
ART SBK 03	1 "	32-35	M8	200	2004871
ART SBK 04	1 1/4 "	40-45	M8	150	2004872
ART SBK 05	1 1/2 "	48-52	M8	125	2004873
ART SBK 06	2 "	56-60	M8	100	2004874
ART SBK 07	2 1/2 "	75-80	M8	100	2004875
ART SBK 08	3 "	86-91	M10	80	2004876
ART SBK 09	4 "	110-115	M10	60	2004877

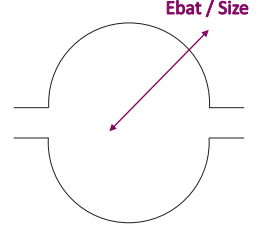

LASTİKLİ TRİFONLU BORU KELEPÇESİ / PIPE CLAMP WITH RUBBER & TRIPHON



Sipariş Kodu Order Code	Ebat Size	Sıkma Aralığı Clamping Range (mm)	Metric (mm)	Paket Miktarı (Ad) Package Content (Pcs)	Barkod Kodu Barcode Code
ART TRBK 01	1/2 "	21-26	M5	150	2004878
ART TRBK 02	3/4 "	26-30	M5	125	2004879
ART TRBK 03	1 "	33-37	M5	100	2004880
ART TRBK 04	1 1/4 "	40-46	M5	75	2004881
ART TRBK 05	1 1/2 "	48-53	M5	50	2004882
ART TRBK 06	2 "	60-66	M5	50	2004883
ART TRBK 07	2 1/2 "	75-84	M6	25	2004884
ART TRBK 08	3 "	87-96	M6	20	2004885
ART TRBK 09	4 "	109-119	M6	15	2004886

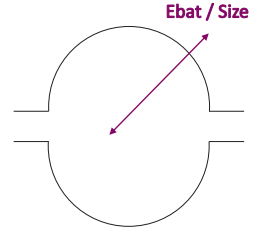

* Farklı kalınlık ve ölçülerde üretim yapılabılır.
* Malzeme ağırlıkları yaklaşık değerlerdir, \pm %10 değişiklik gösterebilir.
* Malzeme kalınlık toleransı \pm %10 dur.
* Lütfen siparişlerinizde sipariş kodu veya ürün kodu ve kaplama şeklini belirtiniz.

* We can produce cable trays different thickness and dimensions
* Cable trays are shown approximately weight, they could change \pm %10 difference.
* Cable trays thickness tolerances are shown \pm %10 .
* Please indicate order code and coating type in your orders.

EMT SERIES BORU SİSTEMLERİ PIPE SYSTEMS

PREGALVANİZ (PG)
PREGALVANİZED (PG)
TS EN 10346

EMT BORU BÜKME APARATI / EMT PIPE BENDING APPARATUS



Sipariş Kodu	Ebat	İç Çap İnner	Paket Miktarı (Ad)	Barkod Kodu
Order Code	Size	Diamete	Package Content (Pcs)	Barcode Code
ART BBA 01	1/2 "	Q 16	1	2004827
ART BBA 02	3/4 "	Q 21	1	2004828
ART BBA 03	1 "	Q 26	1	2004829
ART BBA 04	1 1/4 "	Q 36	1	2004830
ART BBA 05	1 1/2 "	Q 40	1	2004831
ART BBA 06	2 "	Q 51	1	2004832

Alüminyum döküm orjinlidir. / It is of cast aluminum origin.
Kolu kalın dişli borudur. / Its handle is a thick threaded pipe.
EMT Boruyu istenilen açılarda bükme için kullanılır.
It is used to bend EMT Pipe at desired angles.

SİRAL BORU - EMT BORU ADAPTÖRÜ / EMT & FLEXIBLE STEEL CONDUIT CONNECTOR



Sipariş Kodu	Ebat	İç Çap İnner	Paket Miktarı (Ad)	Barkod Kodu
Order Code	Size	Diamete	Package Content (Pcs)	Barcode Code
ART L 153 01	1/2 "	Q 16	50	2004833
ART L 153 02	3/4 "	Q 21	40	2004834
ART L 153 013	1 "	Q 26	20	2004835

Zamak (çinko) döküm orjinlidir. / Zamak (zinc) is cast origin.
Spiral boru girişindeki ayar vidası sayesinde farklı ölçüler takılabilir.
Different sizes can be attached thanks to the adjustment screw at the spiral pipe inlet.

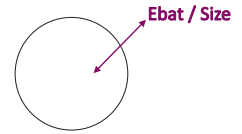

ARTIM METAL ELEKTRİK A.Ş.

* Farklı kalınlık ve ölçülerde üretim yapılabılır.
* Malzeme ağırlıkları yaklaşık değerlerdir, \pm %10 değişiklik gösterebilir.
* Malzeme kalınlık toleransı \pm %10 dur.
* Lütfen siparişlerinizde sipariş kodu veya ürün kodu ve Kaplama şeklini belirtiniz.

* We can produce cable trays different thickness and dimensions
* Cable trays are shown approximately weight, they could change \pm %10 difference.
* Cable trays thickness tolerances are shown \pm %10 .
* Please indicate order code and coating type in your orders.

EMT SERIES BORU SİSTEMLERİ PIPE SYSTEMS

PREGALVANİZ (PG)
PREGALVANIZED (PG)
TS EN 10346

DAHİLİ TİP GALVANİZ ÇELİK BUATLAR / METAL JUNCTION BOXES FOR INDOOR

Sipariş Kodu	Ebat (mm)	Yan Delik (Ad)	Alt Delik (Ad)	Ağırlık (kg/ad)	Barkod Kodu
Order Code	Size (mm)	Side Hole (Pcs)	Bottom Hole (Pcs)	Weight (kg/pcs)	Barcode Code
ART DCKB 701	70x70x25	8 - 3/4 "	2 - 3/4 "	0,135	2004869
ART DCKB 702	70x156x25	12 - 3/4 "	4 - 3/4 "	0,282	2004869
ART DCKB 703	70x245x25	16 - 3/4 "	3 - 3/4 "	0,427	2004869
ART DCKB 704	70x335x25	10-3/4"+ 10-1/2"	4-3/4"+ 4-1/2"	0,573	2004869

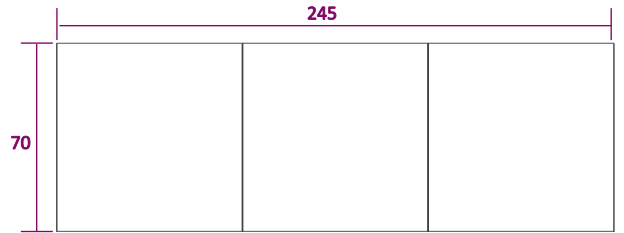
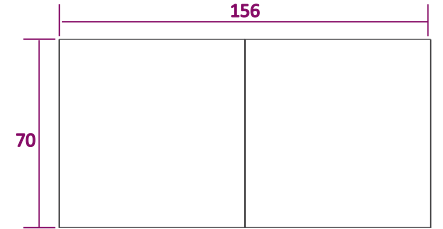
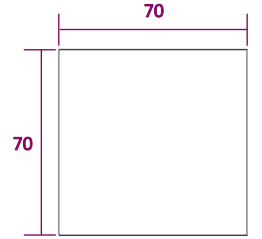

* Farklı kalınlık ve ölçülerde üretim yapılabılır.
* Malzeme ağırlıkları yaklaşık değerlerdir, \pm %10 değişiklik gösterebilir.
* Malzeme kalınlık toleransı \pm %10 dur.
* Lütfen siparişlerinizde sipariş kodu veya ürün kodu ve Kaplama şeklini belirtiniz.

* We can produce cable trays different thickness and dimensions
* Cable trays are shown approximately weight, they could change \pm %10 difference.
* Cable trays thickness tolerances are shown \pm %10 .
* Please indicate order code and coating type in your orders.

art

 WWW.ARTIMMETAL.COM

POWER CARRYING SOLUTIONS

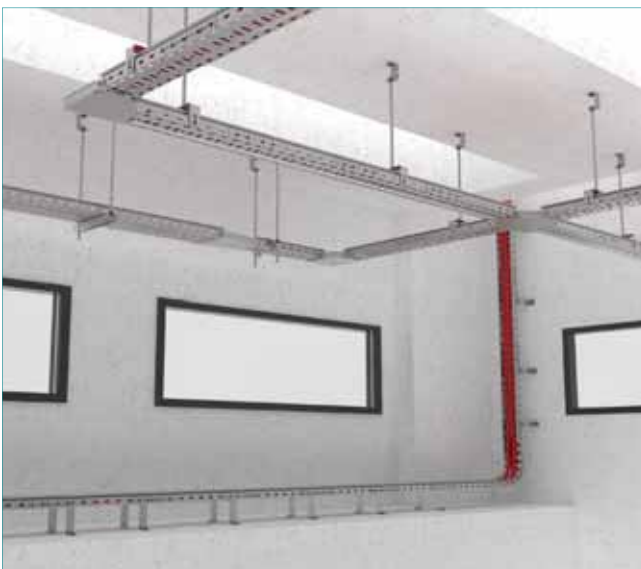

art

POWER CARRYING SOLUTIONS



HIRDAVAT VE AKSESUARLAR

HARDWARE AND ACCESSORIES



AKSESUAR SERIES

AKSESUARLAR

ACCESSORIES

ELEKTRO GALVANİZ (EG)
ELECTRO GALVANIZED (EG)
TS 149

BOMBE BAŞLI KANAL CİVATASI / ROUND HEADED TRAY BOLTS



Sipariş Kodu	Metric	L	Ağırlık (kg/ad)	Paket Miktarı (Ad)	Barkod Kodu
Order Code	(mm)	(mm)	Weight (kg/pcs)	Package Content (Pcs)	Barcode Code
CV-1	M6	15	0,010	300	2008001
CV-2	M8	15	0,012	2.000	2008002
CV-3	M10	25	0,022	-	2008003

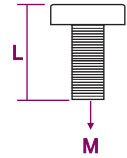

Standart Elektro Galvaniz Kaplı Satılmaktadır.
Talep halinde aşağıdaki yüzey kaplı satış yapılır.
Sold Standard Electro Galvanized.
Upon request, the following surface covered sales are made.
Geomet Kaplama 321 A / Geomet Coating 321 A
Geomet Kaplama 321 B / Geometrical Coating 321 B
304 Kalite Paslanmaz / 304 Quality Stainless
316 Kalite Paslanmaz / 316 Quality Stainless

ANAHTAR BAŞLI CİVATALAR / KEY HEADED BOLTS



Sipariş Kodu	Metric	L	Ağırlık (kg/ad)	Paket Miktarı (Ad)	Barkod Kodu
Order Code	(mm)	(mm)	Weight (kg/pcs)	Package Content (Pcs)	Barcode Code
AAC	M6	25	0,006	300	2008011
AAC-1	M8	25	0,010	500	2008012
AAC-2	M10	25	0,025	100	2008013
AAC-3	M12	25	0,040	100	2008014

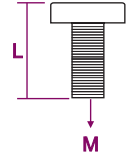

Standart Elektro Galvaniz Kaplı Satılmaktadır.
Talep halinde aşağıdaki yüzey kaplı satış yapılır.
Sold Standard Electro Galvanized.
Upon request, the following surface covered sales are made.
Geomet Kaplama 321 A / Geomet Coating 321 A
Geomet Kaplama 321 B / Geometrical Coating 321 B
304 Kalite Paslanmaz / 304 Quality Stainless
316 Kalite Paslanmaz / 316 Quality Stainless

PROFİL ASKI MENGENESİ / SUPPORT HANGER CLAMP



Sipariş Kodu	Metric	Ağırlık (kg/ad)	Paket Miktarı (Ad)	Barkod Kodu
Order Code	(mm)	Weight (kg/pcs)	Package Content (Pcs)	Barcode Code
APAM-1	M8	0,086	200	2008051
APAM-2	M10	0,140	100	2008052
APAM-3	M12	0,200	50	2008053

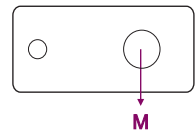

Standart Döküm Kaplı Satılmaktadır.
Standard Casting is Sold.

MAFSALLI ASKI MENGENESİ / HINGE HANGER CLAMP



Sipariş Kodu	Metric	Ağırlık (kg/ad)	Paket Miktarı (Ad)	Barkod Kodu
Order Code	(mm)	Weight (kg/pcs)	Package Content (Pcs)	Barcode Code
APAM-21	M8	0,150	-	2008054
APAM-22	M10	0,160	-	2008055
APAM-23	M12	0,320	-	2008056

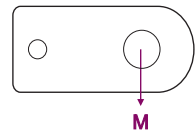

Standart Döküm Kaplı Satılmaktadır.
Standard Casting is Sold.

ARTIM METAL ELEKTRİK A.Ş.

* Farklı kalınlık ve ölçülerde üretim yapılabılır.
* Malzeme ağırlıkları yaklaşık değerlerdir, \pm %10 değişiklik gösterebilir.
* Malzeme kalınlık toleransı \pm %10 dur.
* Lütfen siparişlerinizde sipariş kodu veya ürün kodu ve Kaplama şeklini belirtiniz.

* We can produce cable trays different thickness and dimensions
* Cable trays are shown approximately weight, they could change \pm %10 difference.
* Cable trays thickness tolerances are shown \pm %10 .
* Please indicate order code and coating type in your orders.

AKSESUAR SERIES

AKSESUARLAR

ACCESSORIES

ELEKTRO GALVANİZ (EG)
ELECTRO GALVANIZED (EG)
TS 149



SOMUNLAR / NUTS

Sipariş Kodu	Metric	Ağırlık (kg/ad)	Paket Miktarı (Ad)	Barkod Kodu
Order Code	(mm)	Weight (kg/pcs)	Package Content (Pcs)	Barcode Code
ASN	M6	0,002	300	2008161
ASN-1	M8	0,005	2.000	2008162
ASN-2	M10	0,008	100	2008163
ASN-3	M12	0,015	100	2008164

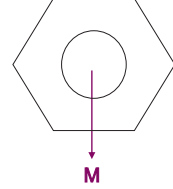

Standart Elektro Galvaniz Kaplı Satılmaktadır. / Sold Standard Electro Galvanized.
Talep halinde aşağıdaki yüzey kaplı satış yapılır. / Upon request, the following surface covered sales are made.
Geomet Kaplama 321 A / Geomet Coating 321 A - Geomet Kaplama 321 B / Geometrical Coating 321 B
304 Kalite Paslanmaz / 304 Quality Stainless - 316 Kalite Paslanmaz / 316 Quality Stainless

FLAŞLI SOMUNLAR / FLANGED NUTS

Sipariş Kodu	Metric	Ağırlık (kg/ad)	Paket Miktarı (Ad)	Barkod Kodu
Order Code	(mm)	Weight (kg/pcs)	Package Content (Pcs)	Barcode Code
ASF	M6	0,003	300	2008151
ASF-1	M8	0,007	2.000	2008152
ASF-2	M10	0,011	100	2008153
ASF-3	M12	0,020	100	2008154

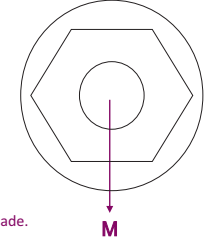

Standart Elektro Galvaniz Kaplı Satılmaktadır. / Sold Standard Electro Galvanized.
Talep halinde aşağıdaki yüzey kaplı satış yapılır. / Upon request, the following surface covered sales are made.
Geomet Kaplama 321 A / Geomet Coating 321 A - Geomet Kaplama 321 B / Geometrical Coating 321 B
304 Kalite Paslanmaz / 304 Quality Stainless - 316 Kalite Paslanmaz / 316 Quality Stainless

UZATMA SOMUNLARI / EXPANSION NUTS

Sipariş Kodu	Metric	L	Ağırlık (kg/ad)	Paket Miktarı (Ad)	Barkod Kodu
Order Code	(mm)	(mm)	Weight (kg/pcs)	Package Content (Pcs)	Barcode Code
ATS-1	M8	25	0,030	500	2008170
ATS-2	M10	30	0,055	-	2008171
ATS-3	M12	35	0,070	-	2008172

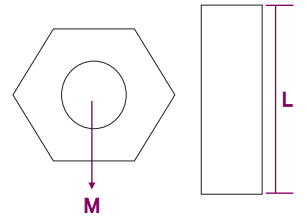

Standart Elektro Galvaniz Kaplı Satılmaktadır. / Sold Standard Electro Galvanized.
Talep halinde aşağıdaki yüzey kaplı satış yapılır. / Upon request, the following surface covered sales are made.
Geomet Kaplama 321 A / Geomet Coating 321 A - Geomet Kaplama 321 B / Geometrical Coating 321 B
304 Kalite Paslanmaz / 304 Quality Stainless - 316 Kalite Paslanmaz / 316 Quality Stainless

YAYLI SOMUNLAR / SPRING NUTS

Sipariş Kodu	Metric	L	Ağırlık (kg/ad)	Paket Miktarı (Ad)	Barkod Kodu
Order Code	(mm)	(mm)	Weight (kg/pcs)	Package Content (Pcs)	Barcode Code
ANSY-1	M8	40	0,046	-	2004267
ANSY-2	M10	40	0,048	-	2004268
ANSY-3	M12	40	0,052	-	2004269

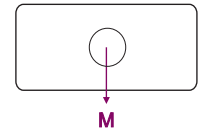

Standart Elektro Galvaniz Kaplı Satılmaktadır. / Sold Standard Electro Galvanized.
Talep halinde aşağıdaki yüzey kaplı satış yapılır. / Upon request, the following surface covered sales are made.
Geomet Kaplama 321 A / Geomet Coating 321 A - Geomet Kaplama 321 B / Geometrical Coating 321 B
304 Kalite Paslanmaz / 304 Quality Stainless - 316 Kalite Paslanmaz / 316 Quality Stainless

* Farklı kalınlık ve ölçülerde üretim yapılabilmektedir.
* Malzeme ağırlıkları yaklaşık değerlerdir, \pm %10 değişiklik gösterebilir.
* Malzeme kalınlık toleransı \pm %10 dur.
* Lütfen siparişlerinizde sipariş kodu veya ürün kodu ve Kaplama şeklini belirtiniz.

* We can produce cable trays different thickness and dimensions
* Cable trays are shown approximately weight, they could change \pm %10 difference.
* Cable trays thickness tolerances are shown \pm %10 .
* Please indicate order code and coating type in your orders.

AKSESUAR SERIES

AKSESUARLAR

ACCESSORIES

ELEKTRO GALVANİZ (EG)
ELECTRO GALVANIZED (EG)
TS 149



PULLAR / WASHER

Sipariş Kodu	Metric	Ağırlık (kg/ad)	Paket Miktarı (Ad)	Barkod Kodu
Order Code	(mm)	Weight (kg/pcs)	Package Content (Pcs)	Barcode Code
APL	M6	0,007	1.000	2008121
APL-1	M8	0,015	2.500	2008122
APL-2	M10	0,032	1.000	2008123
APL-3	M12	0,047	-	2008124

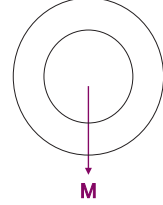

Standart Elektro Galvaniz Kaplı Satılmaktadır. / Sold Standard Electro Galvanized.
Talep halinde aşağıdaki yüzey kaplı satış yapılır. / Upon request, the following surface covered sales are made.
Geomet Kaplama 321 A / Geomet Coating 321 A - Geomet Kaplama 321 B / Geometrical Coating 321 B
304 Kalite Paslanmaz / 304 Quality Stainless - 316 Kalite Paslanmaz / 316 Quality Stainless

YAYLI RONDELA / SPRING WASHER

Sipariş Kodu	Metric	Ağırlık (kg/ad)	Paket Miktarı (Ad)	Barkod Kodu
Order Code	(mm)	Weight (kg/pcs)	Package Content (Pcs)	Barcode Code
AYR	M6	0,002	1.000	2008131
AYR-1	M8	0,011	2.500	2008132
AYR-2	M10	0,016	1.000	2008133
AYR-3	M12	0,040	-	2008134

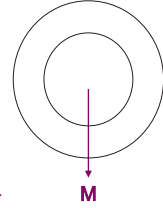

Standart Elektro Galvaniz Kaplı Satılmaktadır. / Sold Standard Electro Galvanized.
Talep halinde aşağıdaki yüzey kaplı satış yapılır. / Upon request, the following surface covered sales are made.
Geomet Kaplama 321 A / Geomet Coating 321 A - Geomet Kaplama 321 B / Geometrical Coating 321 B
304 Kalite Paslanmaz / 304 Quality Stainless - 316 Kalite Paslanmaz / 316 Quality Stainless

ASKI TİLERİ / THREADED HANGING ROD

Sipariş Kodu	Metric	L	Ağırlık (kg/ad)	Paket Miktarı (Ad)	Barkod Kodu
Order Code	(mm)	(mm)	Weight (kg/pcs)	Package Content (Pcs)	Barcode Code
AT-1	M8	2.000	0,650	50	2008301
AT-2	M10	2.000	0,960	25	2008302
AT-3	M12	2.000	1,360	-	2008303



Standart Elektro Galvaniz Kaplı Satılmaktadır. / Sold Standard Electro Galvanized.
Talep halinde aşağıdaki yüzey kaplı satış yapılır. / Upon request, the following surface covered sales are made.
Lak Kaplama / Lac coating - 304 Kalite Paslanmaz / 304 Quality Stainless - 316 Kalite Paslanmaz / 316 Quality Stainless

KOPİLYA / PIN

Sipariş Kodu	Metric	L	Ağırlık (kg/ad)	Paket Miktarı (Ad)	Barkod Kodu
Order Code	(mm)	(mm)	Weight (kg/pcs)	Package Content (Pcs)	Barcode Code
A-KOP	M8	80	0,030	500	2008101



Standart Elektro Galvaniz Kaplı Satılmaktadır. / Sold Standard Electro Galvanized.
Talep halinde aşağıdaki yüzey kaplı satış yapılır. / Upon request, the following surface covered sales are made.
Geomet Kaplama 321 A / Geomet Coating 321 A - Geomet Kaplama 321 B / Geometrical Coating 321 B
304 Kalite Paslanmaz / 304 Quality Stainless - 316 Kalite Paslanmaz / 316 Quality Stainless

ARTIM METAL ELEKTRİK A.Ş.

* Farklı kalınlık ve ölçülerde üretim yapılabilmektedir.
* Malzeme ağırlıkları yaklaşık değerlerdir, \pm %10 değişiklik gösterebilir.
* Malzeme kalınlık toleransı \pm %10 dur.
* Lütfen siparişlerinizde sipariş kodu veya ürün kodu ve Kaplama şeklini belirtiniz.

* We can produce cable trays different thickness and dimensions
* Cable trays are shown approximately weight, they could change \pm %10 difference.
* Cable trays thickness tolerances are shown \pm %10 .
* Please indicate order code and coating type in your orders.

AKSESUAR SERIES

AKSESUARLAR

ACCESSORIES

ELEKTRO GALVANİZ (EG)
ELECTRO GALVANIZED (EG)
TS 149

ÇEKME Lİ TİP ÇELİK DÜBEL / STELL WALL PEG TYPE 1

Sipariş Kodu	Metric	L	Ağırlık (kg/ad)	Paket Miktarı (Ad)	Barkod Kodu
Order Code	(mm)	(mm)	Weight (kg/pcs)	Package Content (Pcs)	Barcode Code
CD-2	M8	-	0,016	450	2008201
CD-3	M10	-	0,030	250	2008202
CD-4	M12	-	0,080	-	2008203



Standart Elektro Galvaniz Kaplı Satılmaktadır. / Sold Standard Electro Galvanized.
Talep halinde aşağıdaki yüzey kaplı satış yapılır. / Upon request, the following surface covered sales are made.
Geomet Kaplama 321 A / Geomet Coating 321 A - Geomet Kaplama 321 B / Geometrical Coating 321 B
304 Kalite Paslanmaz / 304 Quality Stainless - 316 Kalite Paslanmaz / 316 Quality Stainless



SAC GÖMLEKLİ ÇELİK DÜBEL / STELL WALL PEG TYPE 2

Sipariş Kodu	Metric	L	Ağırlık (kg/ad)	Paket Miktarı (Ad)	Barkod Kodu
Order Code	(mm)	(mm)	Weight (kg/pcs)	Package Content (Pcs)	Barcode Code
CSD-2	M8	55	0,028	450	2008211
CSD-3	M10	70	0,060	250	2008212
CSD-4	M12	90	0,110	100	2008213



Standart Elektro Galvaniz Kaplı Satılmaktadır. / Sold Standard Electro Galvanized.
Talep halinde aşağıdaki yüzey kaplı satış yapılır. / Upon request, the following surface covered sales are made.
Geomet Kaplama 321 A / Geomet Coating 321 A - Geomet Kaplama 321 B / Geometrical Coating 321 B
304 Kalite Paslanmaz / 304 Quality Stainless - 316 Kalite Paslanmaz / 316 Quality Stainless



ÇAKMALI TİP ÇELİK DÜBEL / STELL WALL PEG TYPE 3

Sipariş Kodu	Metric	L	Ağırlık (kg/ad)	Paket Miktarı (Ad)	Barkod Kodu
Order Code	(mm)	(mm)	Weight (kg/pcs)	Package Content (Pcs)	Barcode Code
CCD-2	M8	-	0,022	1.000	2008221
CCD-3	M10	-	0,045	500	2008222
CCD-4	M12	-	0,094	-	2008223



Standart Elektro Galvaniz Kaplı Satılmaktadır. / Sold Standard Electro Galvanized.
Talep halinde aşağıdaki yüzey kaplı satış yapılır. / Upon request, the following surface covered sales are made.
Geomet Kaplama 321 A / Geomet Coating 321 A - Geomet Kaplama 321 B / Geometrical Coating 321 B
304 Kalite Paslanmaz / 304 Quality Stainless - 316 Kalite Paslanmaz / 316 Quality Stainless



BORULU ÇELİK DÜBEL / STELL WALL PEG TYPE 5

Sipariş Kodu	Metric	L	Ağırlık (kg/ad)	Paket Miktarı (Ad)	Barkod Kodu
Order Code	(mm)	(mm)	Weight (kg/pcs)	Package Content (Pcs)	Barcode Code
BCD-2	M8	75	0,033	-	2008241
BCD-3	M10	85	0,065	-	2008242
BCD-4	M12	90	0,115	-	2008243



Standart Elektro Galvaniz Kaplı Satılmaktadır. / Sold Standard Electro Galvanized.
Talep halinde aşağıdaki yüzey kaplı satış yapılır. / Upon request, the following surface covered sales are made.
Geomet Kaplama 321 A / Geomet Coating 321 A - Geomet Kaplama 321 B / Geometrical Coating 321 B
304 Kalite Paslanmaz / 304 Quality Stainless - 316 Kalite Paslanmaz / 316 Quality Stainless



* Farklı kalınlık ve ölçülerde üretim yapılabilmektedir.
* Malzeme ağırlıkları yaklaşık değerlerdir, \pm %10 değişiklik gösterebilir.
* Malzeme kalınlık toleransı \pm %10 dur.
* Lütfen siparişlerinizde sipariş kodu veya ürün kodu ve Kaplama şeklini belirtiniz.

* We can produce cable trays different thickness and dimensions
* Cable trays are shown approximately weight, they could change \pm %10 difference.
* Cable trays thickness tolerances are shown \pm %10 .
* Please indicate order code and coating type in your orders.

AKSESUAR SERIES

AKSESUARLAR

ACCESSORIES

ELEKTRO GALVANİZ (EG)
ELECTRO GALVANIZED (EG)
TS 149



KLIPLİ ÇELİK DÜBEL / STEEL WALL PEG TYPE 4

Sipariş Kodu	Metric	L	Ağırlık (kg/ad)	Paket Miktarı (Ad)	Barkod Kodu
Order Code	(mm)	(mm)	Weight (kg/pcs)	Package Content (Pcs)	Barcode Code
KCD-2	M8	75	0,033	-	2008231
KCD-3	M10	90	0,065	-	2008232
KCD-4	M12	90	0,115	-	2008233

Standart Elektro Galvaniz Kaplı Satılmaktadır. / Sold Standard Electro Galvanized.
Talep halinde aşağıdaki yüzey kaplı satış yapılır. / Upon request, the following surface covered sales are made.
Geomet Kaplama 321 A / Geomet Coating 321 A - Geomet Kaplama 321 B / Geometrical Coating 321 B
304 Kalite Paslanmaz / 304 Quality Stainless - 316 Kalite Paslanmaz / 316 Quality Stainless



SİSMİK ASKILAMA SİSTEMİ / SEISMIC HANGING SYSTEM

Sipariş Kodu	Halat Çapı	Kesit	Min. Kopma Dayanımı	1,5 İzin verilen Yük	Barkod Kodu
Order Code	Cable Diameter	Section	Min. Break Strength	1.5 Allowable load	Barcode Code
ART SAS 01	2,4	7x7	420 KG	260 KG	2008181
ART SAS 02	3,2	7x19	830 KG	540 KG	2008182
ART SAS 03	4,8	7x19	1.950 KG	1.280 KG	2008183
ART SAS 04	6,4	7x19	3.320 KG	2.220 KG	2008184

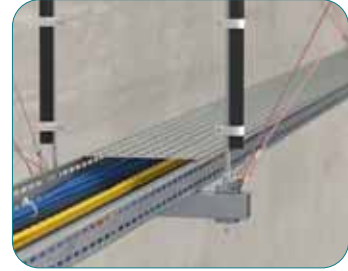

TEK TARAFLI KENAR FİTİLİ / RUBBER STRIP

Sipariş Kodu	Ebat (mm)	Ağırlık (kg/ad)	Paket Miktarı (m)	Barkod Kodu
Order Code	Size (mm)	Weight (kg/pcs)	Package Content (m)	Barcode Code
APF-1	8,5x4,5	-	100	2008105



Standart Siyah Renk Satılmaktadır. / Sold Standard Black Color.
Malzeme PVC / Material PVC.
Renk Seçenekleri + Kırmızı ve + Gri / Color Options + Red and + Gray

ARTIM METAL ELEKTRİK A.Ş.

- * Farklı kalınlık ve ölçülerde üretim yapılabılır.
- * Malzeme ağırlıkları yaklaşık değerlerdir, \pm %10 değişiklik gösterebilir.
- * Malzeme kalınlık toleransı \pm %10 dur.
- * Lütfen siparişlerinizde sipariş kodu veya ürün kodu ve Kaplama şeklini belirtiniz.

- * We can produce cable trays different thickness and dimensions
- * Cable trays are shown approximately weight, they could change \pm %10 difference.
- * Cable trays thickness tolerances are shown \pm %10 .
- * Please indicate order code and coating type in your orders.

AKSESUAR SERIES

AKSESUARLAR

ACCESSORIES

PREGALVANİZ (PG)
PREGALVANIZED (PG)
TS EN 10346

SICAK DALDIRMA (SD)
HOT DIP GALVANIZED (HDG)
TS EN ISO 1461

KANAL ÜSTÜ PRİZ SACI / SOCKET FIXING UNIT ON CABLE TRAYS



Sipariş Kodu	W	T	Ağırlık (kg/ad)	Paket Miktarı (Ad)	Barkod Kodu
Order Code	(mm)	(mm)	Weight (kg/pcs)	Package Content (Pcs)	Barcode Code
PS-1	125	1.50	0,200	-	2008421

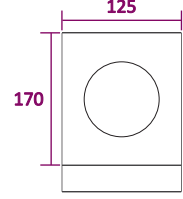

Sipariş Kodu	W	T	Ağırlık (kg/ad)	Paket Miktarı (Ad)	Barkod Kodu
Order Code	(mm)	(mm)	Weight (kg/pcs)	Package Content (Pcs)	Barcode Code
PS-1	125	1.50	0,220	-	2008422

DELİKLİ LAMA / SLOTTED STRIP



Sipariş Kodu	W	T	Ağırlık (kg/ad)	Paket Miktarı (Ad)	Barkod Kodu
Order Code	(mm)	(mm)	Weight (kg/pcs)	Package Content (Pcs)	Barcode Code
CLD-1	40	1.50	0,425	-	2008401
CLD-2	40	1.50	0,475	-	2008402



Sipariş Kodu	W	T	Ağırlık (kg/ad)	Paket Miktarı (Ad)	Barkod Kodu
Order Code	(mm)	(mm)	Weight (kg/pcs)	Package Content (Pcs)	Barcode Code
CLD-3	40	3.00	0,670	-	2008403
CLD-4	40	3.00	0,780	-	2008404

ÇİNKO SPREY / ZINC SPRAY



Sipariş Kodu	Ebat (mm)	Ağırlık (kg/ad)	Paket Miktarı	Barkod Kodu
Order Code	Size (mm)	Weight (kg/pcs)	Package Content	Barcode Code
ASP	-	0,467	400 ml	2008110

* Farklı kalınlık ve ölçülerde üretim yapılabılır.
* Malzeme ağırlıkları yaklaşık değerlerdir, \pm %10 değişiklik gösterebilir.
* Malzeme kalınlık toleransı \pm %10 dur.
* Lütfen siparişlerinizde sipariş kodu veya ürün kodu ve kaplama şeklini belirtiniz.

* We can produce cable trays different thickness and dimensions
* Cable trays are shown approximately weight, they could change \pm %10 difference.
* Cable trays thickness tolerances are shown \pm %10 .
* Please indicate order code and coating type in your orders.

AKSESUAR SERIES

AKSESUARLAR

ACCESSORIES

PREGALVANİZ (PG)

PREGALVANIZED (PG)

TS EN 10346

SICAK DALDIRMA (SD)

HOT DIP GALVANIZED (HDG)

TS EN ISO 1461

H40 KABLO KANALI VE MERDİVEN SONLANDIRMA / H40 CABLE TRAYS AND LADDER END CAPS

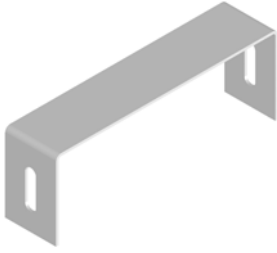

Sipariş Kodu Order Code	W (mm)	T (mm)	Ağırlık (kg/ad) Weight (kg/pcs)	Barkod Kodu Barcode Code
40 ARS 100	100	1.50	0,085	2008451
40 ARS 120	120	1.50	0,095	2008452
40 ARS 160	160	1.50	0,115	2008453
40 ARS 200	200	1.50	0,140	2008454
40 ARS 300	300	1.50	0,175	2008455
40 ARS 400	400	1.50	0,220	2008456
40 ARS 500	500	1.50	0,260	2008457
40 ARS 600	600	1.50	0,305	2008458

PG

SD/HDG

Sipariş Kodu Order Code	W (mm)	T (mm)	Ağırlık (kg/ad) Weight (kg/pcs)	Barkod Kodu Barcode Code
40 ARS 100	100	1.50	0,090	2008451
40 ARS 120	120	1.50	0,105	2008452
40 ARS 160	160	1.50	0,130	2008453
40 ARS 200	200	1.50	0,155	2008454
40 ARS 300	300	1.50	0,195	2008455
40 ARS 400	400	1.50	0,245	2008456
40 ARS 500	500	1.50	0,290	2008457
40 ARS 600	600	1.50	0,335	2008458

H50 KABLO KANALI VE MERDİVEN SONLANDIRMA / H50 CABLE TRAYS AND LADDER END CAPS

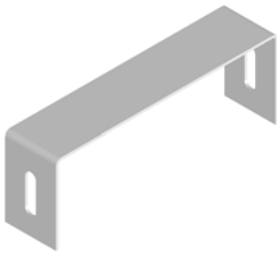

Sipariş Kodu Order Code	W (mm)	T (mm)	Ağırlık (kg/ad) Weight (kg/pcs)	Barkod Kodu Barcode Code
50 ARS 100	100	1.50	0,110	2008461
50 ARS 120	120	1.50	0,127	2008462
50 ARS 160	160	1.50	0,145	2008463
50 ARS 200	200	1.50	0,165	2008464
50 ARS 300	300	1.50	0,225	2008465
50 ARS 400	400	1.50	0,280	2008466
50 ARS 500	500	1.50	0,335	2008467
50 ARS 600	600	1.50	0,390	2008468

PG

SD/HDG

Sipariş Kodu Order Code	W (mm)	T (mm)	Ağırlık (kg/ad) Weight (kg/pcs)	Barkod Kodu Barcode Code
50 ARS 100	100	1.50	0,125	2008461
50 ARS 120	120	1.50	0,142	2008462
50 ARS 160	160	1.50	0,160	2008463
50 ARS 200	200	1.50	0,180	2008464
50 ARS 300	300	1.50	0,250	2008465
50 ARS 400	400	1.50	0,310	2008466
50 ARS 500	500	1.50	0,370	2008467
50 ARS 600	600	1.50	0,430	2008468

ARTIM METAL ELEKTRİK A.Ş.

* Farklı kalınlık ve ölçülerde üretim yapılabılır.
* Malzeme ağırlıkları yaklaşık değerlerdir, \pm %10 değişiklik gösterebilir.
* Malzeme kalınlık toleransı \pm %10 dur.
* Lütfen siparişlerinizde sipariş kodu veya ürün kodu ve kaplama şeklini belirtiniz.

* We can produce cable trays different thickness and dimensions
* Cable trays are shown approximately weight, they could change \pm %10 difference.
* Cable trays thickness tolerances are shown \pm %10 .
* Please indicate order code and coating type in your orders.

AKSESUAR SERIES

AKSESUARLAR

ACCESSORIES

PREGALVANİZ (PG)
PREGALVANIZED (PG)
TS EN 10346

SICAK DALDIRMA (SD)
HOT DIP GALVANIZED (HDG)
TS EN ISO 1461

H60 KABLO KANALI VE MERDİVEN SONLANDIRMA / H60 CABLE TRAYS AND LADDER END CAPS

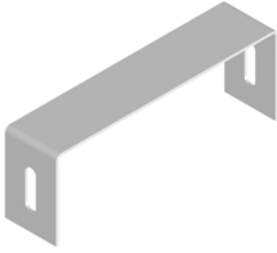

Sipariş Kodu Order Code	W (mm)	T (mm)	Ağırlık (kg/ad) Weight (kg/pcs)	Barkod Kodu Barcode Code
60 ARS 100	100	1.50	0,135	2008471
60 ARS 120	120	1.50	0,155	2008472
60 ARS 160	160	1.50	0,175	2008473
60 ARS 200	200	1.50	0,205	2008474
60 ARS 300	300	1.50	0,270	2008475
60 ARS 400	400	1.50	0,340	2008476
60 ARS 500	500	1.50	0,405	2008477
60 ARS 600	600	1.50	0,475	2008478



SD/HDG

Sipariş Kodu Order Code	W (mm)	T (mm)	Ağırlık (kg/ad) Weight (kg/pcs)	Barkod Kodu Barcode Code
60 ARS 100	100	1.50	0,150	2008471
60 ARS 120	120	1.50	0,173	2008472
60 ARS 160	160	1.50	0,195	2008473
60 ARS 200	200	1.50	0,225	2008474
60 ARS 300	300	1.50	0,300	2008475
60 ARS 400	400	1.50	0,375	2008476
60 ARS 500	500	1.50	0,445	2008477
60 ARS 600	600	1.50	0,525	2008478

H100 KABLO KANALI VE MERDİVEN SONLANDIRMA / H100 CABLE TRAYS AND LADDER END CAPS

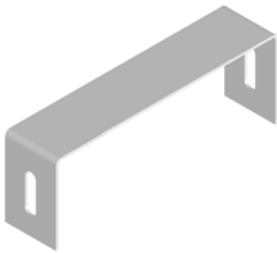

Sipariş Kodu Order Code	W (mm)	T (mm)	Ağırlık (kg/ad) Weight (kg/pcs)	Barkod Kodu Barcode Code
100 ARS 100	100	1.50	0,230	2008481
100 ARS 120	120	1.50	0,255	2008482
100 ARS 160	160	1.50	0,285	2008483
100 ARS 200	200	1.50	0,345	2008484
100 ARS 300	300	1.50	0,460	2008485
100 ARS 400	400	1.50	0,575	2008486
100 ARS 500	500	1.50	0,690	2008487
100 ARS 600	600	1.50	0,805	2008488



SD/HDG

Sipariş Kodu Order Code	W (mm)	T (mm)	Ağırlık (kg/ad) Weight (kg/pcs)	Barkod Kodu Barcode Code
100 ARS 100	100	1.50	0,255	2008481
100 ARS 120	120	1.50	0,280	2008482
100 ARS 160	160	1.50	0,305	2008483
100 ARS 200	200	1.50	0,380	2008484
100 ARS 300	300	1.50	0,510	2008485
100 ARS 400	400	1.50	0,635	2008486
100 ARS 500	500	1.50	0,760	2008487
100 ARS 600	600	1.50	0,885	2008488

* Farklı kalınlık ve ölçülerde üretim yapılabilmektedir.
* Malzeme ağırlıkları yaklaşık değerlerdir, \pm %10 değişiklik gösterebilir.
* Malzeme kalınlık toleransı \pm %10 dur.
* Lütfen siparişlerinizde sipariş kodu veya ürün kodu ve kaplama şeklini belirtiniz.

* We can produce cable trays different thickness and dimensions
* Cable trays are shown approximately weight, they could change \pm %10 difference.
* Cable trays thickness tolerances are shown \pm %10 .
* Please indicate order code and coating type in your orders.



YÜKLEME & PAKETLEME LOADING & PACKING





YÜKLEME & PAKETLEME LOADING & PACKING





KALITE KONTROL
QUALITY CONTROL



SICAK DALDIRMA GALVANİZ (TS 914)

Galvaniz,

450-455 C° deki erimiş çinkonun içine daldırılan demirin kaplanmasına denir. Çinko, demirle kuvvetli bağlar yaparak üçlü bir faz tabakası meydana getirir.

Özellikle paslanmaya karşı yapılan bu işlem dışarıda, açık havada her türlü hava koşullarında çalışacak metallerin ömrünün uzatılması için yapılmaktadır. Galvaniz olmuş metale kromat kaplanırsa ömrü artar. Galvaniz işleminden sonra dikkat edilmesi gerekenler, galvanizin mikron değeri, malzemeye yapışkanlık uygunluğu, varsa deliklerdeki çapaklanmalar, uç kısımlarındaki galvaniz birikintileri, birbirine yapışmış malzemeler, dros yapışması, kaplanmamış bölümler, kül yapışması ve beyaz paslara dikkat edilmelidir. Demir malzeme galvanizlemeye uygun olarak imalat aşamasında tasarlanmalıdır. Çinko giriş delikleri ve basınç çıkış delikleri özellikle içi boş olan malzemelerde önemlidir.

Çinko ve Galvanizleme

- Galvaniz fabrikaları %90 saflıkta çinko kullanır,
- %100 geri dönüşümlüdür,
- İmalat ve uygulama aşamalarında solvent yâda ozon tabakasına zararlı komponentler bulunmamaktadır,
- Benzer uygulamalardan % 50 daha az sera gazı etkisi göstermektedir,
- Galvaniz fabrikaları atıklarının tamamı ya galvanizleme prosesinde geri dönüşür ya da diğer yan sanayide yeniden işlenmek için alınır,
- Açık yâda kapalı deşarj ünitelerine, kanallara atık verilmez,
- Çinko üretilmesi için tüketilen enerji benzer metallerin gereksiniminden daha azdır.

Çinko Galvanizleme Prosesleri

Yağ alma: Galvaniz kaplaması için gelen malzemelerin yüzeylerindeki yağ veya gres kalıntıları asidik veya alkali yağ alma yöntemlerinden biri kullanılarak yağ amla banyosunda temizlenirler. Organik yağ alma yöntemi ise nadiren kullanılan bir metot dur. Eğer alkali veya organik yağ alma metotları kullanılıyor ise yağ alma banyosundan gelen kalıntıların diğer banyolara taşınmaması için su banyosuna daldırılarak yıkama işlemi gerçekleştirilmelidir.

Asit ile Yüzey Temizleme: Çelik ve dökme demir yüzeyinde oluşan pas ve hadde tufalını kaldırıp temiz bir metalik yüzey elde etmek için malzemeler, seyreltilmiş hidroklorik asit banyolarına daldırılır. Asit ile yüzey temizleme süresi malzemenin pas derecesine ve asit banyosunun konsantrasyonuna bağlı olarak değişiklik gösterir. Genellikle asit banyolarında çalışma sıcaklığı 20-30C° aralığındadır.

Yıkama: Asit ile kimyasal temizleme işleminden sonra asit kalıntılarının bir sonraki banyoya taşınmasını engellemek için su banyosunda yıkama işlemi yapılır.

Kurutma: Flaks banyosundan ıslak çıkan parçalar kurutma fırınında kurutma işlemine tabi tutulur. Genellikle kurutma fırınının ısıtılmasında galvaniz banyosunun atık gazlarından yararlanır.

Flaks Kaplama: Asit ve yıkama işlemlerinden sonra flaks kaplama prosesi gerçekleştirilerek flaks malzeme yüzeyinde kalan küçük kalıntıların temizlenmesini sağlar. Flaks kaplama çelik yüzeyinin çinko banyosundaki reaksiyonunun daha iyi gerçekleşmesini sağlar. Flaks kaplama çinko klorür-amonyum klorür karışımından oluşur. Flaks kaplama galvanizleme işleminde farklı metotlar kullanılarak uygulanabilir. Örneğin, en çok uygulanan metot, flaksın su ile seyreltilip bir banyo içerisinde solüsyon hale getirilecek parçaların bu banyonun içine daldırılmasıdır. Diğer alternatif yöntemler ise flaksın parçalar üzerine sıvı olarak spreyleme ve flaksın toz olarak parça yüzeyine temas ettirilme yöntemleridir veya flaksın eriyik çinko banyosunun yüzeyine serpilerek parçaların kaplama esnasında flaks ile teması sağlanabilir.

Sıcak Daldırma Galvaniz: Sıcak daldırma galvaniz, çelik ve döküm parçalarının korozyona karşı direncini arttırmak için 450C°deki sıvı çinko banyosuna daldırılarak kaplanması yöntemidir. Bu yöntemle malzeme yüzeyinde demir(Fe) çinko (Zn) alaşımları oluşturularak korozyona karşı koruma sağlanır.

Soğutma: Galvaniz kaplanmış ürünlerin havada ya da suya daldırılarak soğuması sağlanması işlemidir.

Pasivasyon: Müşteri isteği doğrultusunda galvaniz kaplanmış ürünler pasivasyon prosesine tabi tutulur. Pasivasyon prosesindeki amaç, beyaz pas oluşumunu engellemektir.



3 Farklı Kaplama Yönteminin Karşılaştırması

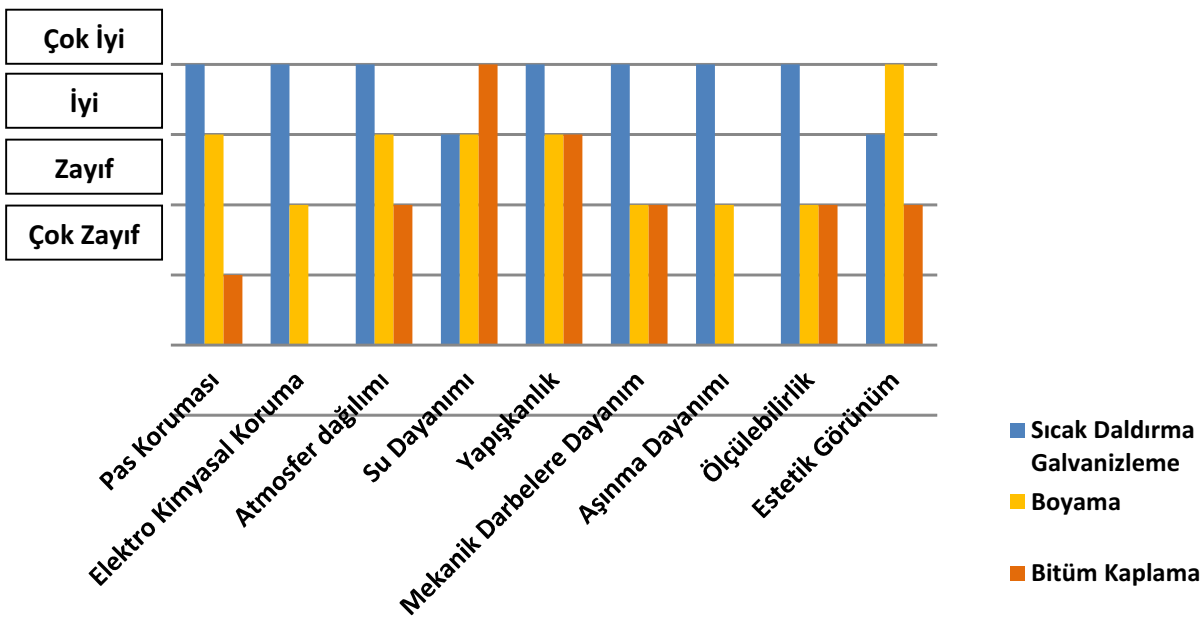

Malzeme ve Kalınlığı	Minimum Yerel kaplama Kalınlığı $\mu(\text{gr}/\text{m}^2)$	Minimum Ortalama Kaplama Kalınlığı $\mu(\text{gr}/\text{m}^2)$
Çelik > 6 mm	70 (505)	85 (610)
Çelik >3 mm - < 6 mm	55 (395)	70 (505)
Çelik >1,5mm - <3 mm	45 (325)	55 (395)
Çelik < 1,5mm	35 (250)	45 (324)
Dökümler > 6 mm	70 (505)	80 (575)
Dökümler <6 mm	60 (430)	70 (505)

Beyaz Pas Oluşumu Ve Önlemleri

Beyaz pas, rutubetli ve yetersiz havalandırma koşullarında bekleyen kaplanmış sac malzemenin üzerindeki çinkonun karbondioksit(CO₂) ile rutubetten kaynaklı suyun reaksiyonu sonucu oluşur.

Beyaz pas denilen görüntü beyaz ya da gri renkte küf ve tortu halinde görünmektedir.

Genelde sıkıntının olduğu noktalar;

- Sevkiyat esnasında,
- Şantiyede olumsuz depo koşullarında,
- İstif aralıklar olmayan ürünlerde daha sık görülmektedir. Özellikle beyaz pasın en önemli sebebi su dur.

Galvaniz ürünlerin beyaz pas oluşumunun önüne geçilmesi için;

- Soğukluk ve sıcaklık derecelerinin istif ortamında neme sebebiyet vermeyecek şekilde ayarlanması gerekmektedir,
- Taşıma esnasında kesinlikle ıslanmamalıdır,
- Çok sıkı ve hava akımına izin vermeyecek bir yükleme yapılmamalıdır,
- ıslanılan ürünler fark edildiği andan itibaren silinmeli ve kurulanmalıdır,
- İstiflenen ürünler palet üzeri olmalı yer ile temastan kaçınılmalıdır.

PREGALVANİZ (TS 822)

Galvanize yassı çelikler, soğuk haddelenmiş metalin sıcak daldırma prosesiyle her iki yüzeyinde çinko tabakası ile kaplanmasıyla üretilen işlemdir. Kaplanmış ve yüzeyi pürüzsüz olan sac üretime hazır haldedir. Bu daldırma yöntemi ile yapılan kaplama değerleri her iki yüzey için 10-18 μm arası gelmektedir. Pregalvaniz sacdan üretilen sac kablo kanalları daha çok bina içi gibi kuru havanın bulunduğu alanlarda kullanılmalıdır. Nem ve rutubetli ortamlarda korozyona sebebiyet vermektedir.

METAL BOYA Elektrostatik Toz Boya

Elektrostatik toz boyama işlemi sanayinin renklendirme ve boyamada en çok tercih ettiği yüzey işlem yöntemidir. Yüzeyi kaplayan, son kat boya tabakasını oluşturan çok ince toz boya partikülleridir. Astar, solvent gibi ekstra maliyetler olmadığından uygun dayanım yüksekliği bakımından üstün bir uygulamadır. Toz boya, boya kabini özel boya tabancaları ile atılır. Tabancadan geçerken elektrostatik yüklenen toz boya partikülleri kabin içinden içinde boyanacak malzemeye yapışır ve kaplama işlemi gerçekleşmiş olur. Toz boyanın malzeme yüzeyine tam olarak yapışabilmesi için malzemenin de çok iyi şekilde topraklanması ve boyama öncesi yüzey işleminin malzemenin cinsine uygun olarak en iyi şekilde yapılması gerekir. Bu yüzey işlemleri yağ alma, fosfatlama vs. Malzeme uygun işlemine tabi tutulup toz boya ile kaplandıktan sonra pişirme fırınına girer. 200C° ve üstü olan fırın ısısı toz boyanın erimesine ve malzeme üzerinde homojen yapışmasını sağlar. Fırından çıkan malzeme kullanıcısı ile buluşmaya hazırdır.

Epoksi ve Polyester Boyalar

Boya ile ilgili olarak; Sürtünmeye ve aşınmaya karşı dayanıklıdır,

- Yağ ve kimyasallara karşı dirençlidir,
- Yüksek mekanik direnç sağlarlar,
- Korozyona karşı dirençlidir,
- Epoksi UV dayanımı yüksek olmadığından iç mekanlarda tercih edilir,
- Geniş renk yelpazesine sahiptir.
- Polyester Boya UV dayanımı yüksektir ve dış mekanlarda rahat kullanılır.

TS 149 ELEKTRO GALVANİZ

Sac üzerinde kesme delme, bükme, kaynaklama gibi işlemlerden sonra iyonize kanalı ile çinko kaplama işlemidir. 8-12 mikron kaplama şartlarında kullanılmaktadır.

Elektro galvaniz kaplama;

Kimyasal alaşımlarla çinko anottan malzeme katota doğru yapılan galvanizleme işlemidir. Azda olsa malzemeye bir sertlik sağlar. Ürün kaplama sonrası parlak bir görünüm almaktadır. Elektro galvaniz ince bir kaplama olmasına rağmen güçlü bir koruma sağlamaktadır. Civata, somun, tij, pul, rondela, çelikdübel gibi ürünler elektro galvaniz yöntemi ile kaplanmaktadır.

DAKROMET

Dakromet, çinko ve alüminyum parçalarından oluşan yüksek dayanımlı inorganik bir kaplamadır. En önemli özelliği düşük kalınlıkta yüksek korozyona dayanım sağlamaktadır. Taşıma sistemlerinde kullanılan hırdavat malzemesi diye adlandırdığımız (civata, somun, tij, pul, rondela) dış açılmış olan ürün yüzeylerinde çinko oluşmaması ve ürüne zarar vermemesi amacı ile dakromet kaplama isteğe göre tercih edilir.

NYY Kabloların Değerleri

Anma Kesiti mm ²	Tel Sayısı mm	İletken Çapı Mm	Yalıtkan Kılıf Et Kalın. mm	Dış Kılıf Et Kalın. mm	Dıştan Dışa Çap mm	Büküm Çapı Ohm/km	Direnç Ohm/km	Akım Taşıma Kapasitesi A-A	Ağırlık kg/km
1x1,5	1	1,38	1,5	1,8	8	11	11,9	37-26	65
1x2,5	1	1,80	1,5	1,8	8,4	11	7,14	50-35	80
1x4	1	2,26	1,5	1,8	8,9	12	4,47	65-46	110
1x6	1	2,80	1,5	1,8	9,4	13	2,97	93-58	140
1x10	1-7	4,1	1,5	1,8	10,7	14	1,79	110-80	195
1x16	1-7	5,2	1,5	1,8	11,7	15	1,12	145-105	270
1x25	7	6,4	1,5	1,8	12,9	18	0,712	190-140	370
1x35	7-19	7,7	1,5	1,8	14,1	20	0,514	235-175	480
1x50	19	9,2	1,5	1,8	15,6	23	0,379	280-215	640
1x70	19	11	1,5	1,8	17,2	26	0,262	350-270	850
1x95	19	12,7	1,6	1,8	19,4	29	0,189	420-335	1115
1x120	37	14,4	1,6	1,8	21,4	2930	0,150	480-390	1340
1x150	37	16,1	1,8	1,8	23	33	0,122	540-445	1660
1x185	37	18	2,0	2,0	25,7	36	0,0972	620-510	2030
1x240	61	20,5	2,2	2,0	29	44	0,0740	770-620	2650
1x300	61	22,7	2,4	2,0	32	48	0,0590	820-710	3370
2x1,5	1	1,38	0,3	1,8	11	14	12,1	30-21	170
2x2,5	1	1,80	0,9	1,8	13	16	7,28	41-29	220
2x4	1	2,26	1,0	1,8	14	17	4,56	53-38	290
2x6	1	2,80	1,0	1,8	15	18	3,03	66-48	350
2x10	1-7	4,1	1,0	1,8	17	21	1,83	88-66	480
3x1,5	1	1,38	0,8	1,8	12	15	12,1	27-18	190
3x2,5	1	1,80	0,9	1,8	13	16	7,28	36-25	260
3x4	1	2,26	1,0	1,8	15	19	4,56	46-34	340
3x6	1	2,80	1,0	1,8	16	20	2,03	58-44	420
3x10	1-7	4,1	1,0	1,8	17	21	1,83	77-60	580
4x1,5	1	1,38	0,8	1,8	13	16	12,1	27-18	230
4x2,5	1	1,8	10,9	1,8	14	17	7,28	36-25	300
4x4	1	2,26	1,0	1,8	16	19	4,56	46-34	410
4x6	1	2,80	1,0	1,8	17	21	3,03	58-44	510
4x10	1-7	4,1	1,0	1,8	20	23	1,83	77-60	780
4x16	1-7	5,2	1,0	2,0	23	27	1,15	100-80	1100
3x25/16	7	6,4	1,5	2,0	27	33	0,727	130-105	1420
3x35/25	7-19	7,7	1,5	2,0	30	36	0,524	155-130	1790
3x50/25	19	9,2	1,5	2,2	36	44	0,387	185-160	2290
3x70/35	19	11	1,5	2,2	40	49	0,268	230-200	3066
3x95/50	19	12,7	1,6	2,4	45	55	0,193	275-245	4097
3x120/70	37	14,4	1,6	2,6	50	61	0,153	315-285	5700
3x150/70	37	16,1	1,8	2,8	52	69	0,124	355-325	6132
3x185/95	37	18	2,0	3,0	59	77	0,991	400-370	7625
3x240/120	61-37	20,5	2,2	3,2	66	82	0,574	460-435	9950
3x300/150	61-37	22,7	2,4	3,4	73	92	0,0601	520-500	12500

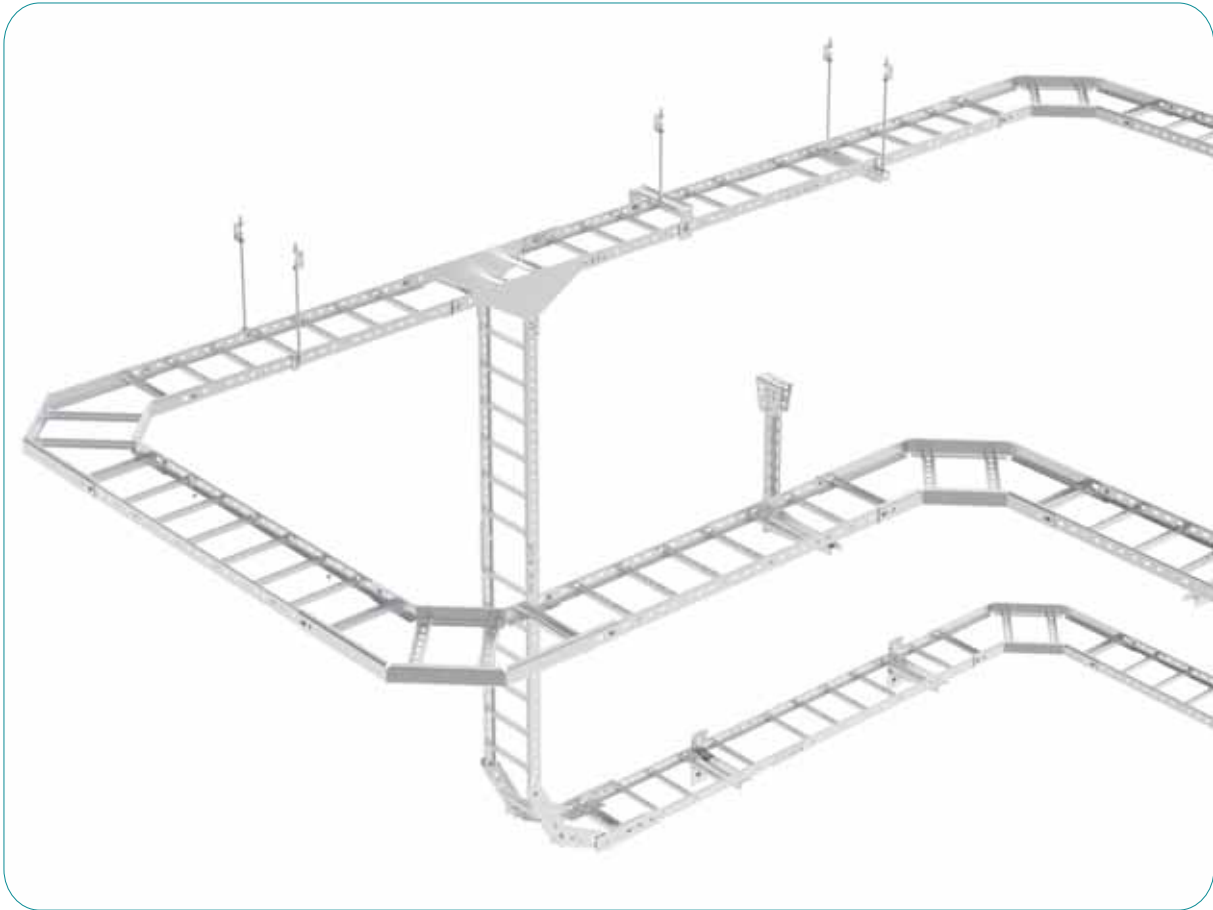

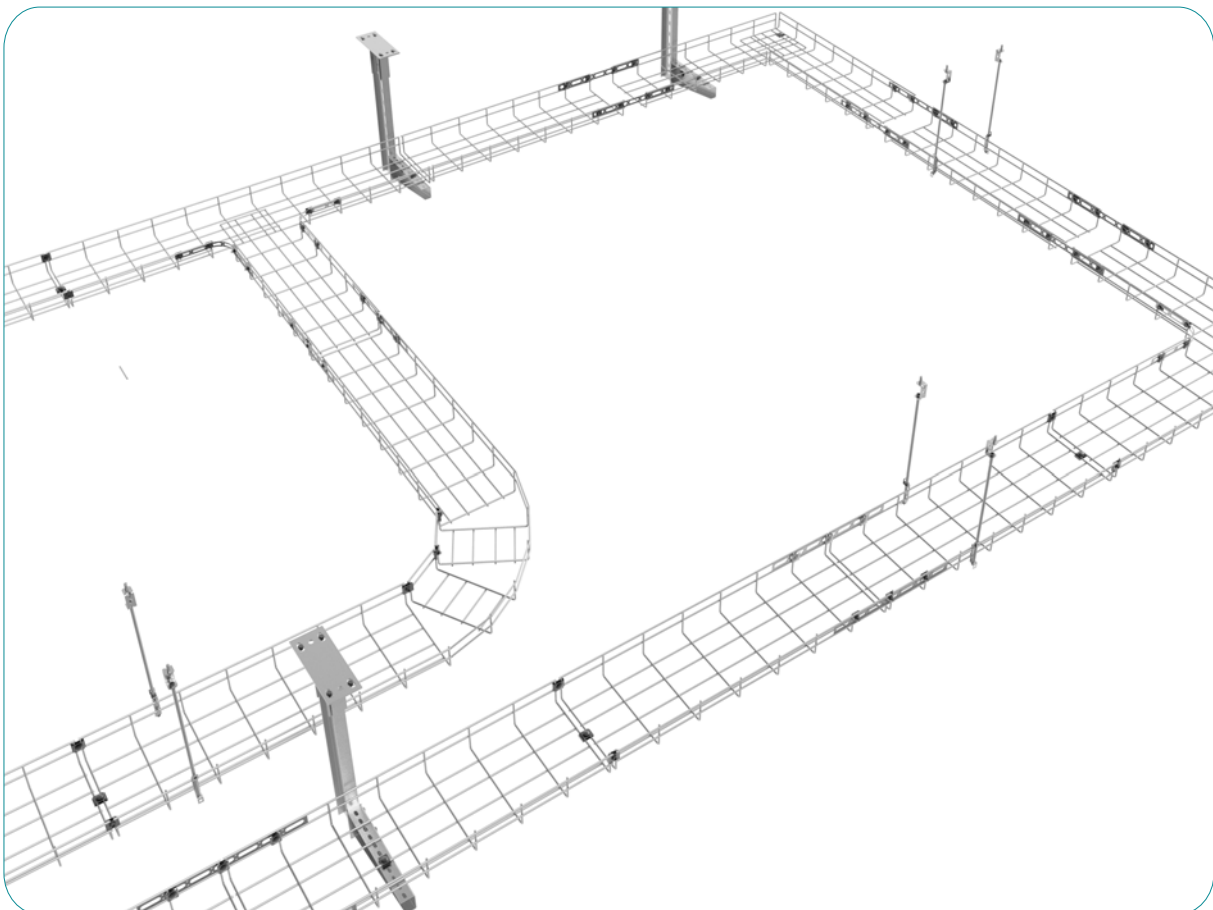
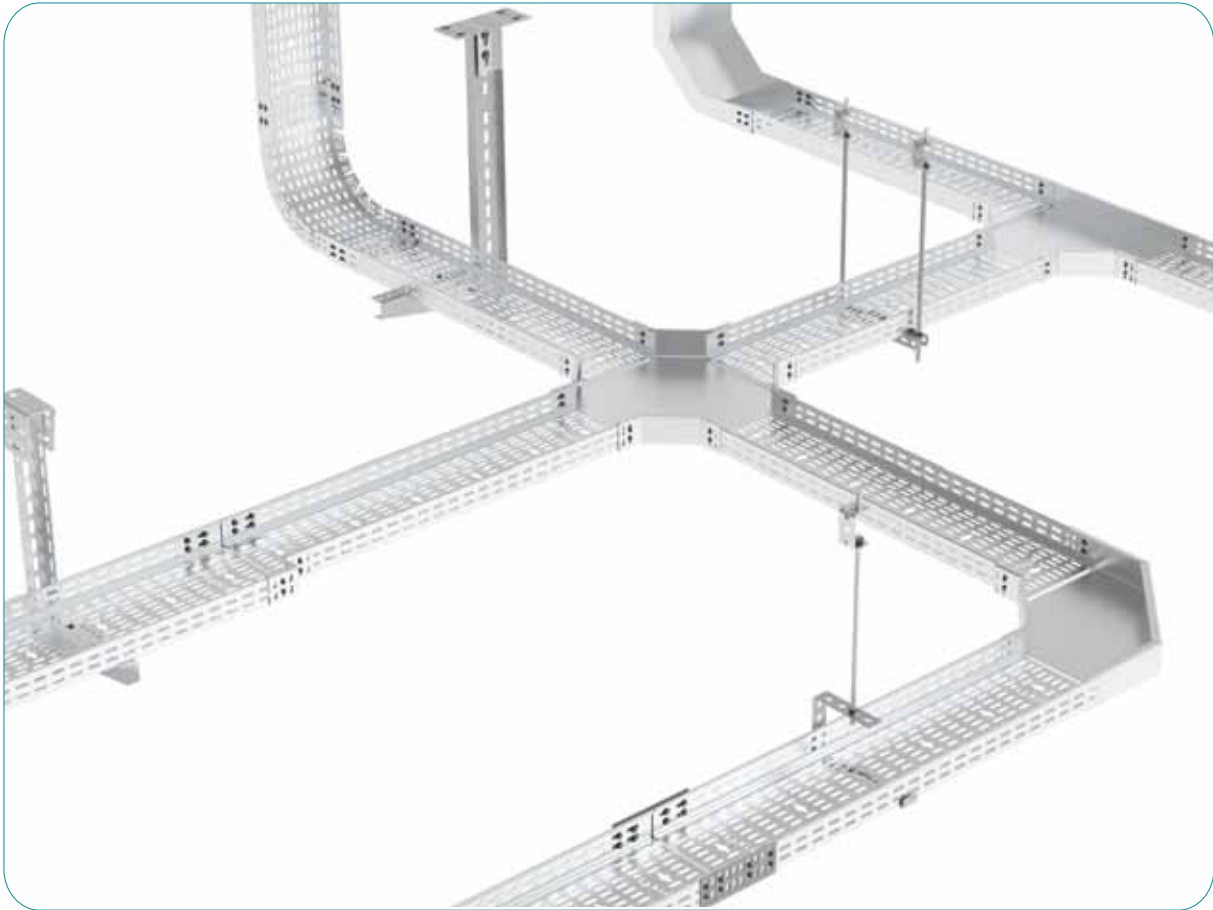

art

POWER CARRYING SOLUTIONS

ARTIM METAL ELEKTRİK SAN. TİC. A.Ş.

Head Office - Factory / Satış Ofisi - Fabrika

- 📍 Yeşilbayır Mh. Hadımköy İstanbul Cd. No. 130 B
Hadımköy – İstanbul – TÜRKİYE
- ☎️ +90 212 549 42 90 (Pbx) 📞 +90 212 549 42 97
- ✉️ info@artimmetal.com • artim@artimmetal.com

www.artimmetal.com

